

CONFIDENTIAL

**SAMSUNG**

## LCD-TV

Chassis	Model
AL29JO	LT29A13W
AL40JO	LT40A13W

# *SERVICE* Manual

LCD-TV

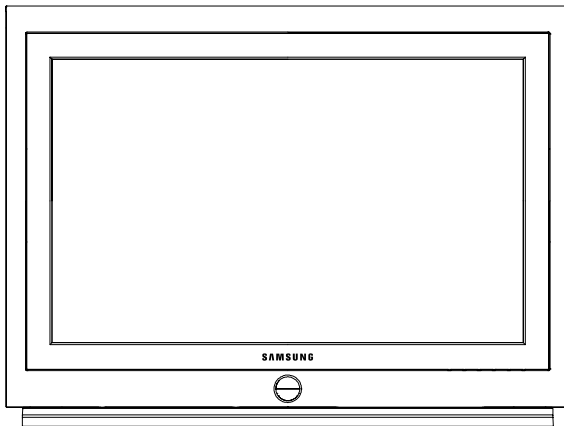

CONTENTS

1. Precautions
2. Product Specifications
3. Disassembly & Reassembly
4. Troubleshooting
5. Exploded View & Parts List
6. Electrical Parts List
7. Block Diagram
8. Wiring Diagram
9. Schematic Diagrams
10. Panel Description

# 1 Precautions

Follow these safety, servicing and ESD precautions to prevent damage and to protect against potential hazards such as electrical shock.

## 1-1 Safety Precautions

### 1-1-1 Warnings

1. For continued safety, do not attempt to modify the circuit board.
2. Disconnect the AC power and DC Power Jack before servicing.

### 1-1-2 Servicing the LCD Monitor

1. When servicing the LCD Monitor disconnect the AC line cord from the AC outlet.
2. It is essential that service technicians have an accurate voltage meter available at all times. Check the calibration of this meter periodically.

### 1-1-3 Fire and Shock Hazard

Before returning the monitor to the user, perform the following safety checks:

1. Inspect each lead dress to make certain that the leads are not pinched or that hardware is not lodged between the chassis and other metal parts in the monitor.
2. Inspect all protective devices such as nonmetallic control knobs, insulating materials, cabinet backs, adjustment and compartment covers or shields, isolation resistor-capacitor networks, mechanical insulators, etc.
3. Leakage Current Hot Check (Figure 1-1):

**WARNING:**

Do not use an isolation transformer during this test. Use a leakage current tester or a metering system that complies with American National Standards Institute (*ANSI C101.1, Leakage Current for Appliances*), and Underwriters Laboratories (*UL Publication UL1410, 59.7*).

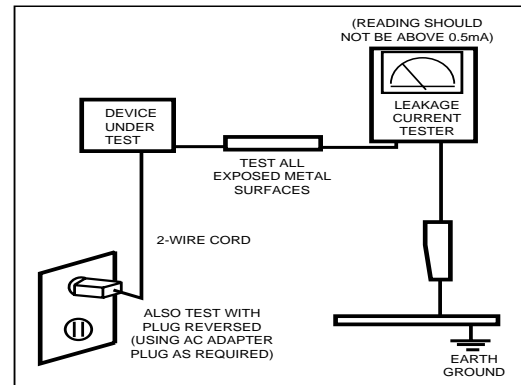

Figure 1-1. Leakage Current Test Circuit

4. With the unit completely reassembled, plug the AC line cord directly into a 120V AC outlet. With the unit's AC switch first in the ON position and then OFF, measure the current between a known earth ground (metal water pipe, conduit, etc.) and all exposed metal parts, including: metal cabinets, screwheads and control shafts. The current measured should not exceed 0.5 milliamp. Reverse the power-plug prongs in the AC outlet and repeat the test.

### 1-1-4 Product Safety Notices

Some electrical and mechanical parts have special safety-related characteristics which are often not evident from visual inspection. The protection they give may not be obtained by replacing them with components rated for higher voltage, wattage, etc. Parts that have special safety characteristics are identified by ⚠ on schematics and parts lists. A substitute replacement that does not have the same safety characteristics as the recommended replacement part might create shock, fire and / or other hazards. Product safety is under review continuously and new instructions are issued whenever appropriate.

## 1-2 Servicing Precautions

---

**WARNING:** An electrolytic capacitor installed with the wrong polarity might explode.

**Caution:** Before servicing units covered by this service manual, read and follow the Safety Precautions section of this manual.

**Note:** If unforeseen circumstances create conflict between the following servicing precautions and any of the safety precautions, always follow the safety precautions.

### 1-2-1 General Servicing Precautions

1. Always unplug the unit's AC power cord from the AC power source and disconnect the DC Power Jack before attempting to:
  - (a) remove or reinstall any component or assembly,
  - (b) disconnect PCB plugs or connectors, (c) connect a test component in parallel with an electrolytic capacitor.
2. Some components are raised above the printed circuit board for safety. An insulation tube or tape is sometimes used. The internal wiring is sometimes clamped to prevent contact with thermally hot components. Reinstall all such elements to their original position.
3. After servicing, always check that the screws, components and wiring have been correctly reinstalled. Make sure that the area around the serviced part has not been damaged.
4. Check the insulation between the blades of the AC plug and accessible conductive parts (examples: metal panels, input terminals and earphone jacks).
5. Insulation Checking Procedure: Disconnect the power cord from the AC source and turn the power switch ON. Connect an insulation resistance meter (500 V) to the blades of the AC plug.  
The insulation resistance between each blade of the AC plug and accessible conductive parts (see above) should be greater than 1 megohm.
6. Always connect a test instrument's ground lead to the instrument chassis ground before connecting the positive lead; always remove the instrument's ground lead last.

## 1-3 Electrostatically Sensitive Devices (ESD) Precautions

---

Some semiconductor (solid state) devices can be easily damaged by static electricity. Such components are commonly called Electrostatically Sensitive Devices (ESD). Examples of typical ESD are integrated circuits and some field-effect transistors. The following techniques will reduce the incidence of component damage caused by static electricity.

1. Immediately before handling any semiconductor components or assemblies, drain the electrostatic charge from your body by touching a known earth ground. Alternatively, wear a discharging wrist-strap device. To avoid a shock hazard, be sure to remove the wrist strap before applying power to the monitor.
2. After removing an ESD-equipped assembly, place it on a conductive surface such as aluminum foil to prevent accumulation of an electrostatic charge.
3. Do not use freon-propelled chemicals. These can generate electrical charges sufficient to damage ESDs.
4. Use only a grounded-tip soldering iron to solder or desolder ESDs.
5. Use only an anti-static solder removal device. Some solder removal devices not classified as "anti-static" can generate electrical charges sufficient to damage ESDs.
6. Do not remove a replacement ESD from its protective package until you are ready to install it. Most replacement ESDs are packaged with leads that are electrically shorted together by conductive foam, aluminum foil or other conductive materials.
7. Immediately before removing the protective material from the leads of a replacement ESD, touch the protective material to the chassis or circuit assembly into which the device will be installed.  
**Caution:** Be sure no power is applied to the chassis or circuit and observe all other safety precautions.
8. Minimize body motions when handling unpackaged replacement ESDs. Motions such as brushing clothes together, or lifting your foot from a carpeted floor can generate enough static electricity to damage an ESD.

## 2 Product Specifications

### 2-1 Specifications

Item	Description	
	LT29A13W	LT40A13W
LCD Panel	TFT-LCD panel, RGB vertical stripe, normally black transmissive, (29 -Inch) viewable, 0.4935 mm pixel pitch	TFT-LCD panel, RGB vertical stripe, normally black transmissive, (40-Inch) viewable, 0.6735 mm pixel pitch
Scanning Frequency	Horizontal : 30 KHz ~ 61 KHz Vertical : 56 Hz ~ 75 Hz	
Display Colors	16,777,216 colors	
Maximum Resolution	Horizontal : 1280 Pixels Vertical : 768 Pixels	
Input Video Signal	Analog, 0.7 Vp-p ± 5% positive at 75 Ω, internally terminated	
Input Sync Signal	Type : Separate H/V sync, Composite H/V, Sync-on-Green Level : TTL level	
AC power voltage & Frequency	AC 90 ~ 240V 60 Hz/50 Hz ± 3 Hz, DC 28V / 8A	
Power Consumption	135W (max)	200W (max)
Dimensions Unit (W x D x H) Carton (W x D x H)	29.9 x 20.0 x 1.9 Inches (760 x 506 x 49.0 mm) 29.9 x 22.4 x 7.7 Inches (760 x 569 x 195 mm) 37.8 x 22.4 x 7.7 Inches (961 x 569 x 195 mm)	39.6 x 28.1 x 2.3 Inches (1006 x 713 x 58.0 mm) 39.6 x 29.4 x 11.8 Inches (1006 x 747 x 300 mm) 49.1 x 29.4 x 11.8 Inches (1248 x 747 x 300 mm)
Weight (Net / Gross)	11.2 kg (24.7 lbs) 13.7 kg (30.2 lbs) 16.0 kg (35.3 lbs)	21.5 kg (47.4 lbs) 28.0 kg (61.7 lbs) 32.0 kg (70.5 lbs)
Environmental Considerations	Operating Temperature : 50°F ~ 104°F (10°C ~ 40°C) Humidity : 10 % ~ 80 % Storage Temperature : -4°F ~ 113°F (-20°C ~ 45°C) Humidity : 5 % ~ 95 %	
TV System	Color	NTSC-M
	Sound	BTSC, A2 STEREO, EIAJ
Antenna Input	75Ω, Coaxial Cable	
Sound Characteristics	<ul style="list-style-type: none"> <li>• Max Internal speaker Out : Right c 10 W / Left c 10 W</li> <li>• Bass control Range : -6 ± -12dB ~ +6 ± 12dB</li> <li>• TREBLE control Range : -10 ± -12dB ~ +10 ± 12dB</li> <li>• Output frequency : RF c 80 Hz~15 KHz / A/V c 80 Hz~20 KHz</li> <li>• Line out : RF c 80 Hz~15 KHz / A/V c 80 Hz~20 KHz</li> </ul>	
<ul style="list-style-type: none"> <li>• Designs and specifications are subject to change without prior notice.</li> </ul>		

## 2-2 PC Timing Chart

This section of the service manual describes the timing that the computer industry recognizes as standard for computer-generated video signals.

Table 2-1 Timing Chart

Mode \ Timing	VGA/60 Hz 640 x 480	VGA/72 Hz 640 x 480	VGA/75 Hz 640 x 480	SVGA/56 Hz 800 x 600	SVGA/60 Hz 800 x 600	SVGA/72 Hz 800 x 600	SVGA/72 Hz 1280 x 768
fH (kHz)	31.5	37.9	37.5	35.2	37.9	48.1	47.7
A pixels	800	832	840	1024	1056	1040	1680
B pixels	96	40	64	72	128	120	136
C pixels	40	120	120	128	88	64	200
D pixels	640	640	640	800	800	800	1280
E pixels	8	16	16	24	40	56	64
fV (Hz)	60.0	72.8	75.0	56.3	60.3	72.2	60
O lines	525	520	500	625	628	666	795
P lines	2	3	3	2	4	6	3
Q lines	25	20	16	22	23	23	23
R lines	480	480	480	600	600	600	768
S lines	2	1	1	1	1	37	1
Clock Freq. (MHz)	25.175	31.500	31.500	36.000	40.000	50.000	80.136
Polarity H.Sync	Negative	Negative	Negative	-/+	Positive	Positive	*
V.Sync	Negative	Negative	Negative	-/+	Positive	Positive	*
Remark	Separate	Separate	Separate	Separate	Separate	Separate	Separate

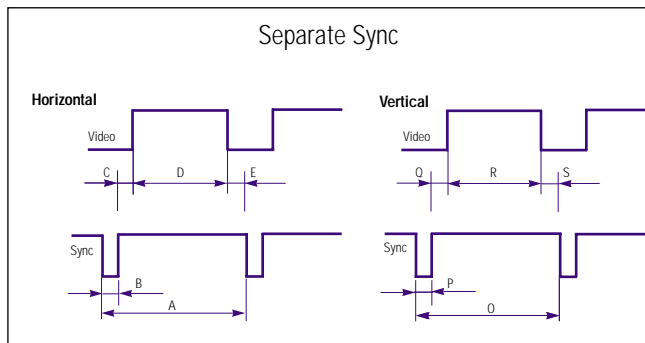

A : Line time total	B : Horizontal sync width	O : Frame time total	P : Vertical sync width
C : Back porch	D : Active time	Q : Back porch	R : Active time
E : Front porch		S : Front porch	

Table 2-2 Timing Chart (continued)

Mode Timing	SVGA/75 Hz 800 x 600	XGA/60 Hz 1024 x 768	XGA/70 Hz 1024 x 768	XGA/75 Hz 1024 x 768
fH (kHz)	46.9	48.4	56.5	60.0
A pixels	1056	1344	1328	1312
B pixels	80	136	136	96
C pixels	160	160	144	176
D pixels	800	1024	1024	1024
E pixels	16	24	24	16
fV (Hz)	75.0	60.0	70.1	75.0
O liues	625	806	806	800
P liues	3	6	6	3
Q liues	21	29	29	28
R liues	600	768	768	768
S liues	1	3	3	1
Clock Freq. (MHz)	49.500	65.000	75.000	78.750
Polarity H.Sync	Positive	Negative	Negative	Positive
V.Sync	Positive	Negative	Negative	Positive
Remark	Separate	Separate	Separate	Separate

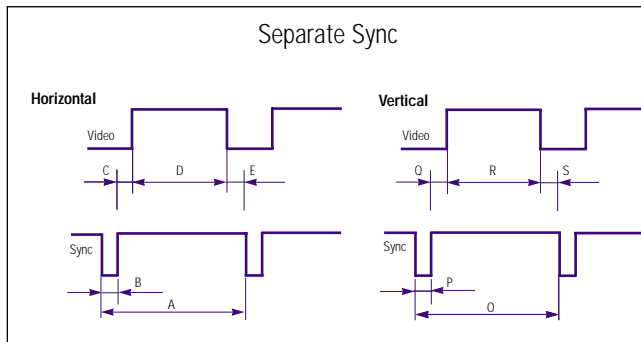

A : Line time total	B : Horizontal sync width	O : Frame time total	P : Vertical sync width
C : Back porch	D : Active time	Q : Back porch	R : Active time
E : Front porch		S : Front porch	

**Memo**

## 3 Disassembly and Reassembly

This section of the service manual describes the disassembly and reassembly procedures for the LT29A13W/LT40A13W monitor.

**WARNING:** This monitor contains electrostatically sensitive devices. Use caution when handling these components.

### 3-1 Disassembly

**Cautions:** 1. Disconnect the monitor from the power source before disassembly.  
2. Follow these directions carefully; never use metal instruments to pry apart the cabinet.



1. Remove 4 screws of the cover rear.



2. Remove the stand from LCD-TV.





3. Remove 4 screws of the cover rear.



4. Pull the cover rear.

### **3-2 Reassembly**

---

Reassembly procedures are in the reverse order of Disassembly procedures.

**Copyright**

© 2002 by Samsung Electronics Co., Ltd.

All rights reserved.

This manual may not, in whole or in part, be copied, photocopied, reproduced, translated, or converted to any electronic or machine readable form without prior written permission of Samsung Electronics Co., Ltd.

LT29A13W/LT40A13W Service Manual

First edition October 2002.

Printed in Korea.

**Trademarks**

Samsung is the registered trademark of Samsung Electronics Co., Ltd.

LT29A13W/LT40A13W and MacMaster Cable Adapter are trademarks of Samsung Electronics Co., Ltd.

Macintosh, Centris, Quadra, Duo Douk, and Power Macintosh are trademarks of Apple Computer, Inc.

All other trademarks are the property of their respective owners.

## 4 Troubleshooting

### 4-1-1 No Picture (Lamp off, LED on)

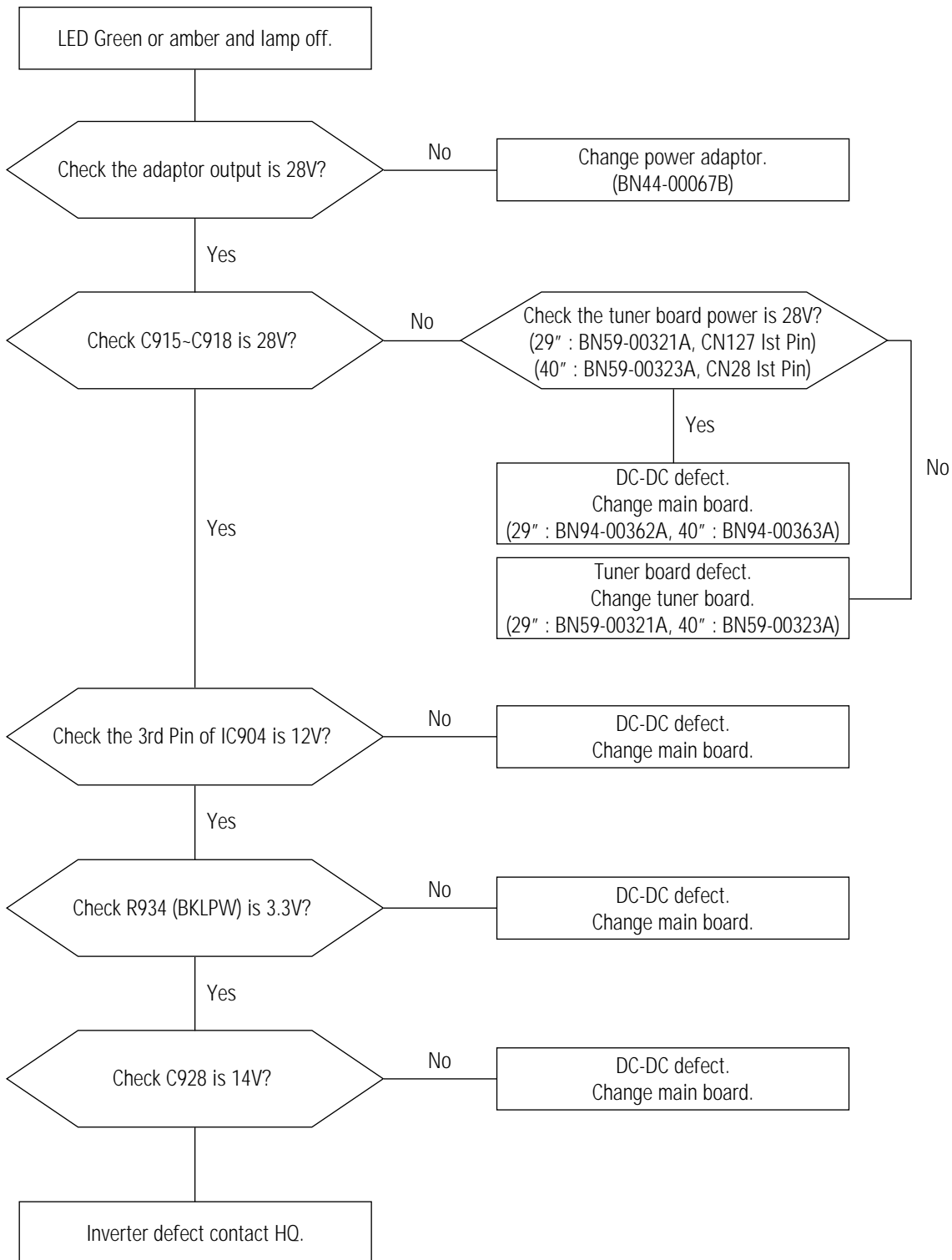

### 4-1-2 No Picture (RF Signal)

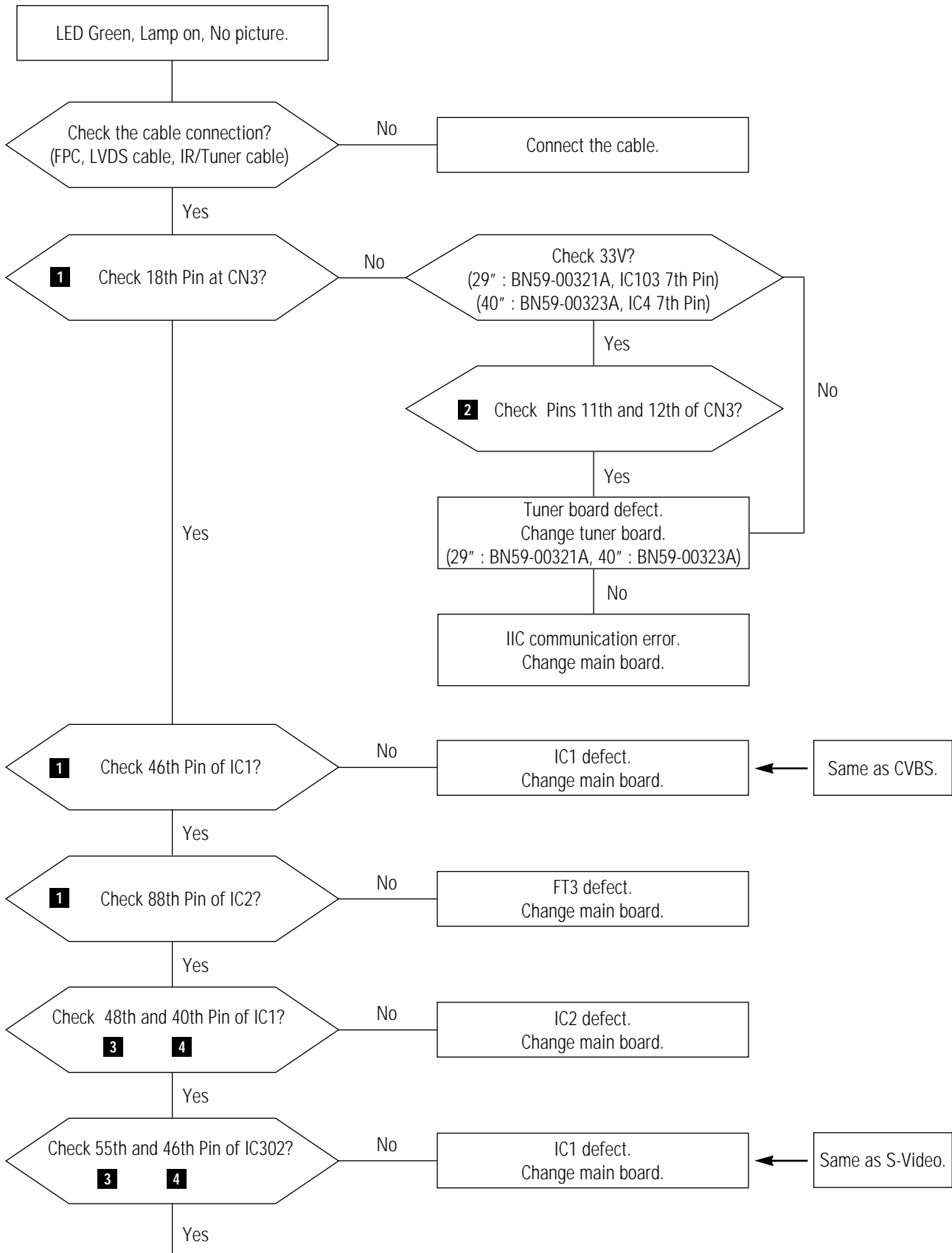

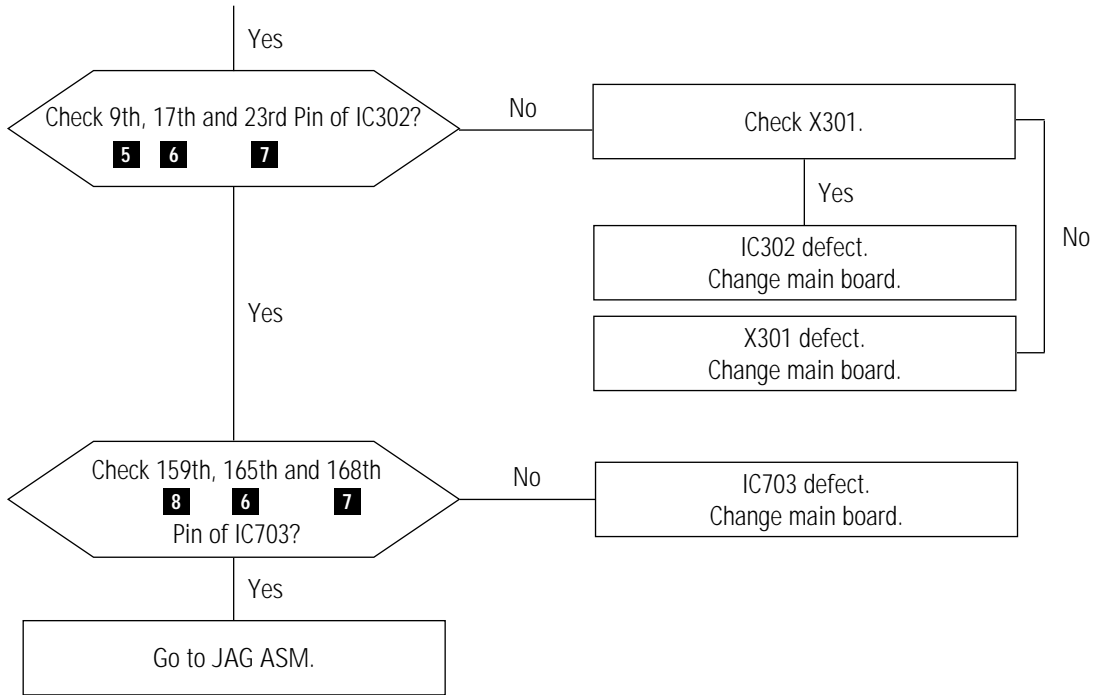

### 4-1-3 No Picture (CVBS Signal)

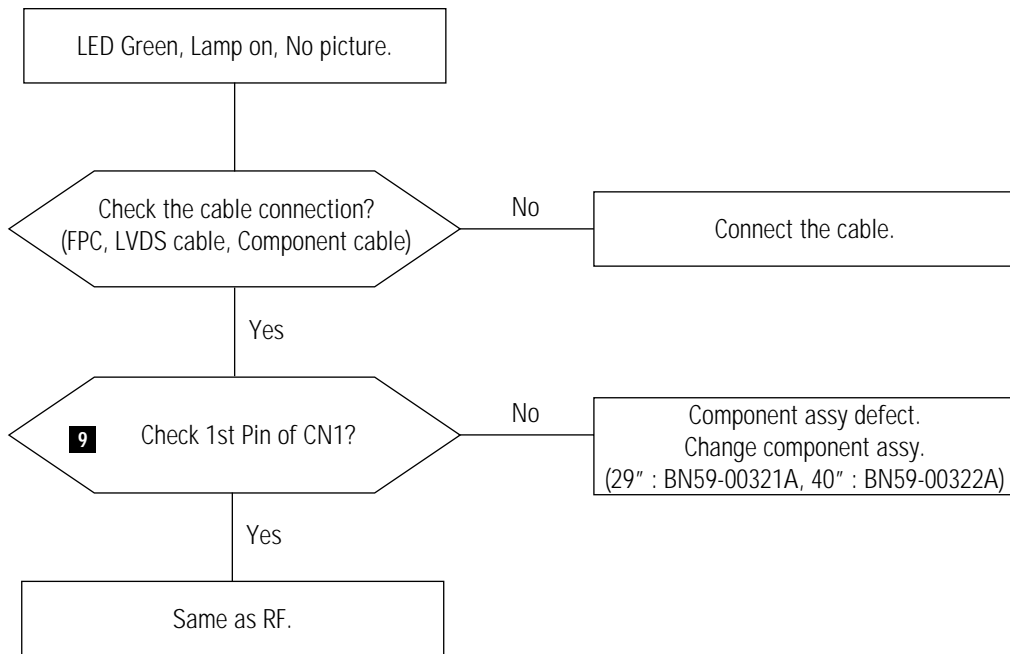

**WAVEFORMS**

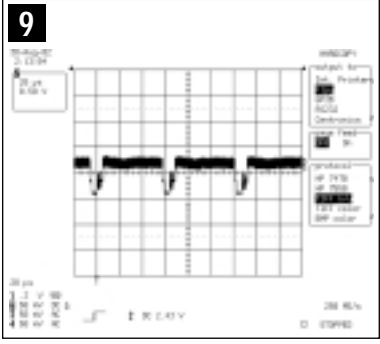
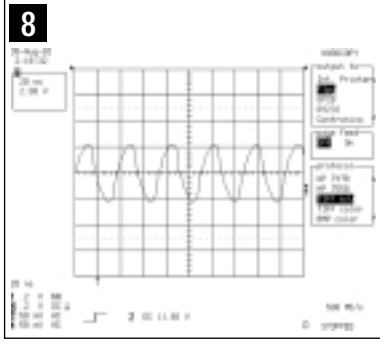
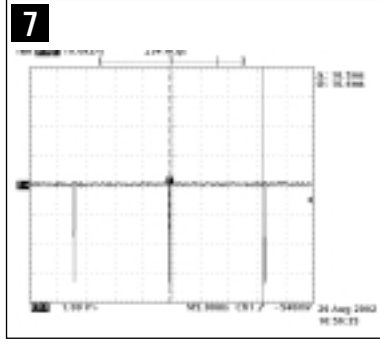
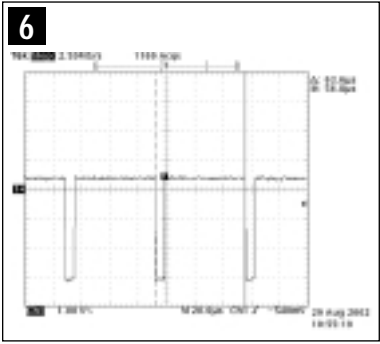
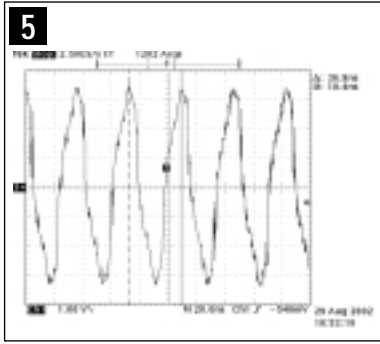
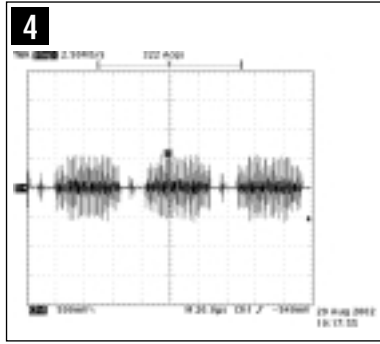
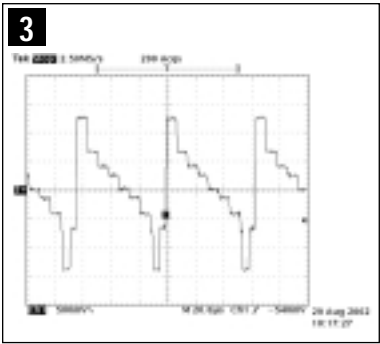
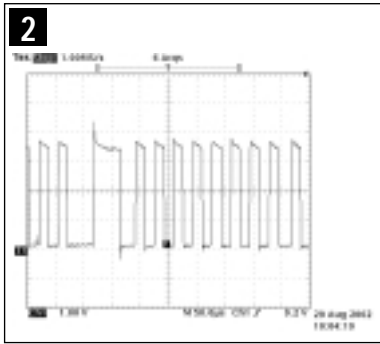
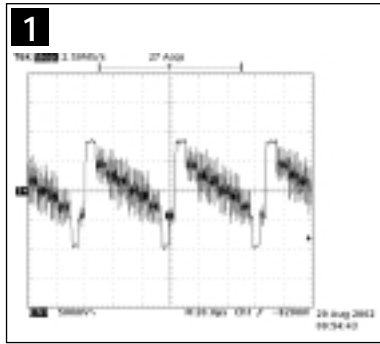

### 4-1-4 No Picture (S-Video Signal)

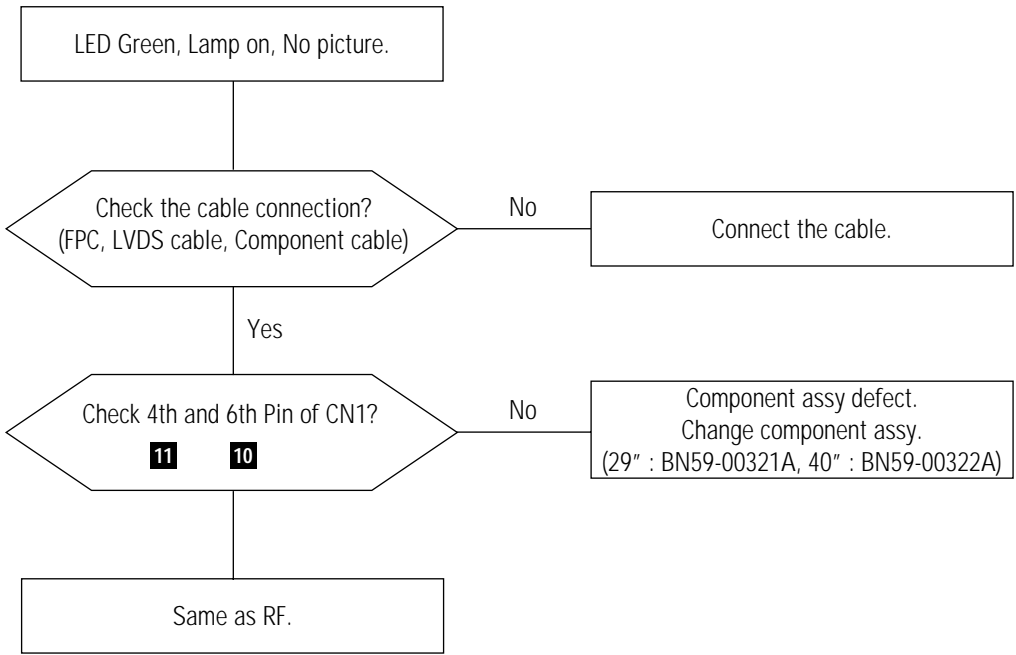

### WAVEFORMS

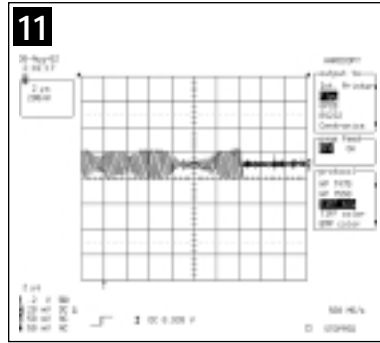
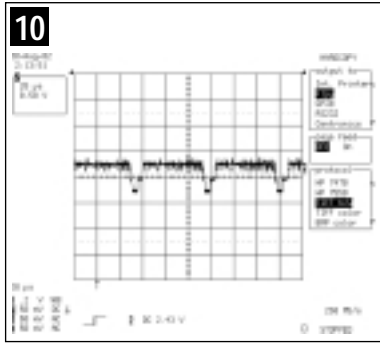

### 4-1-5 No Picture (D4 Signal)

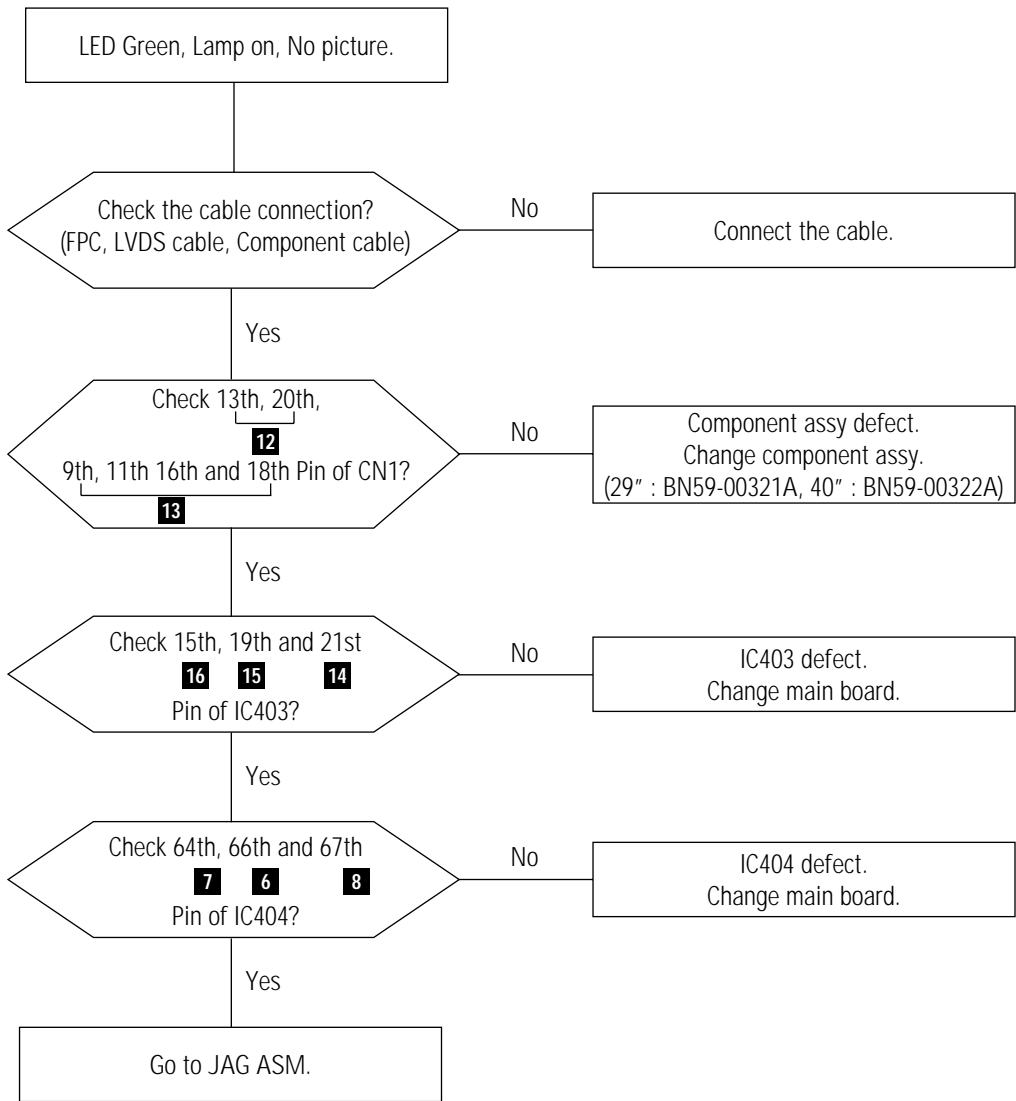



**WAVEFORMS**

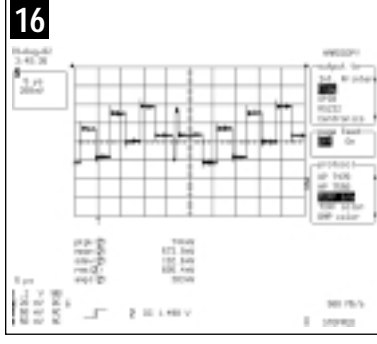
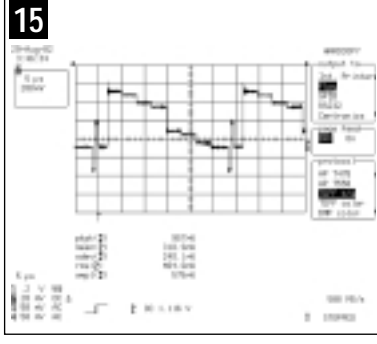
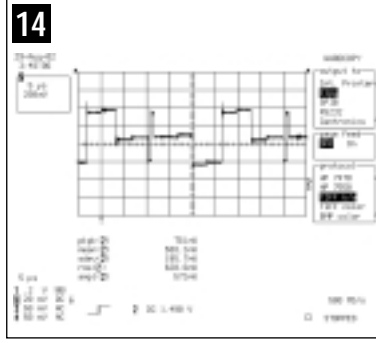
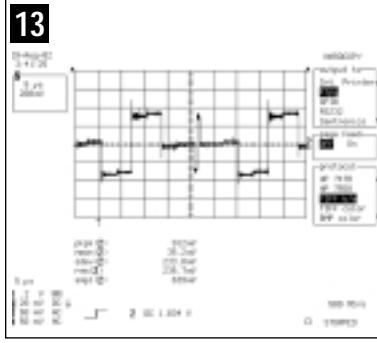
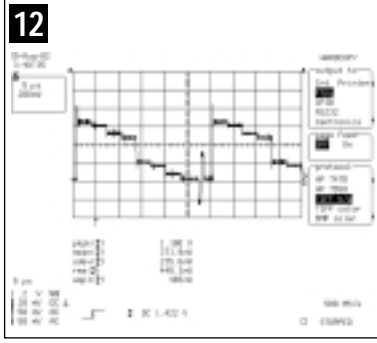
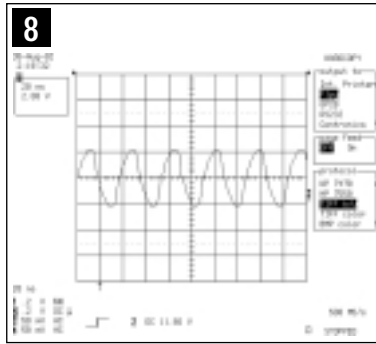
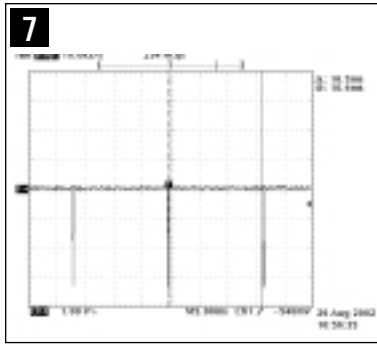
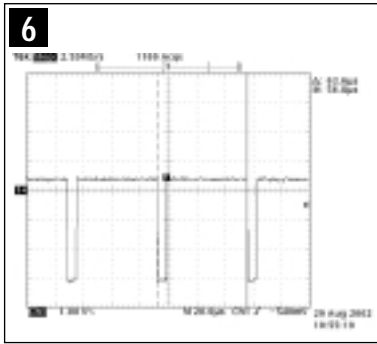

**4-1-6 No Picture (PC Analog)**

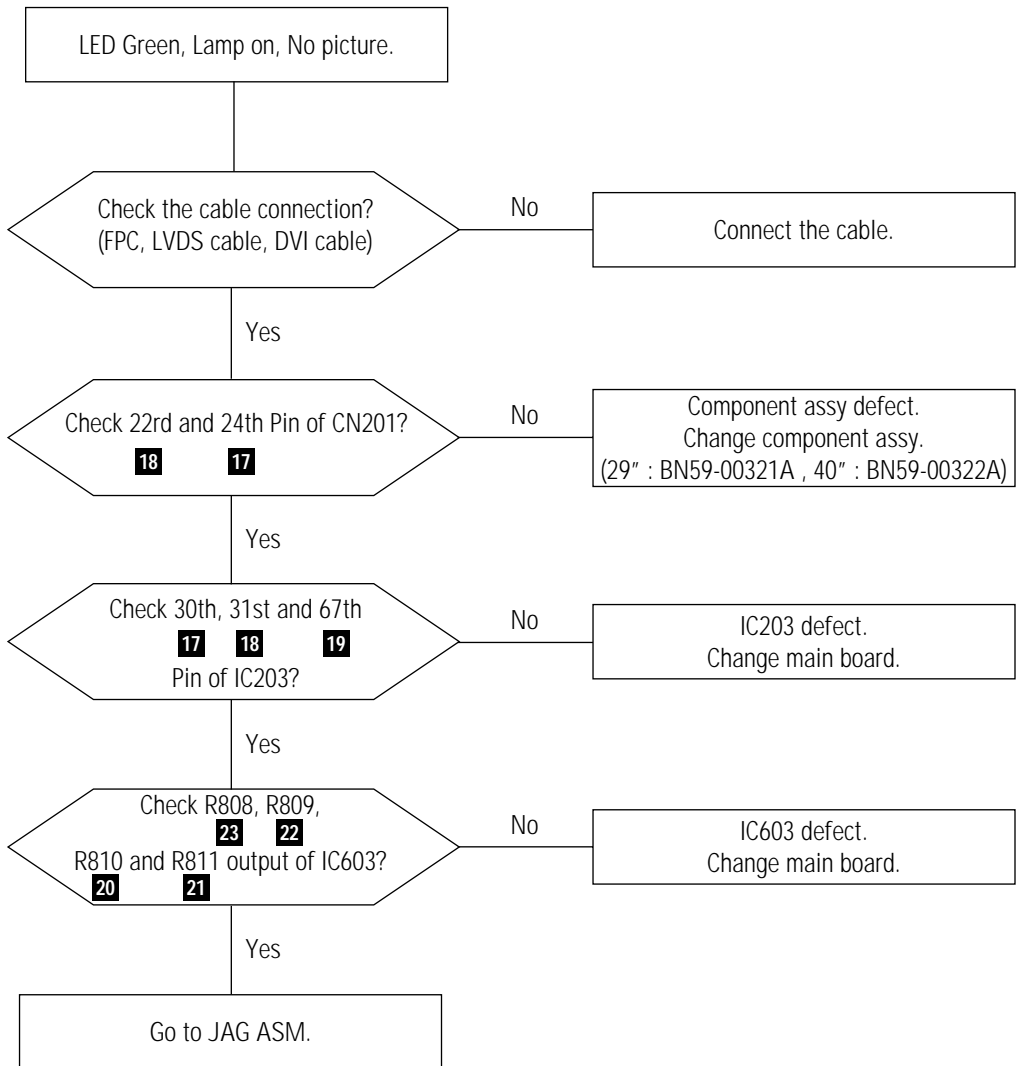

**WAVEFORMS**

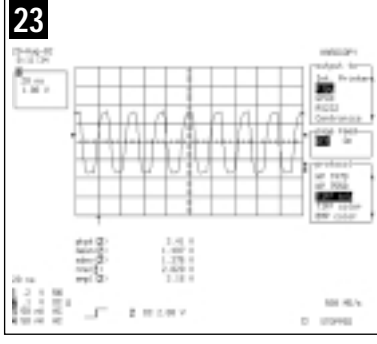
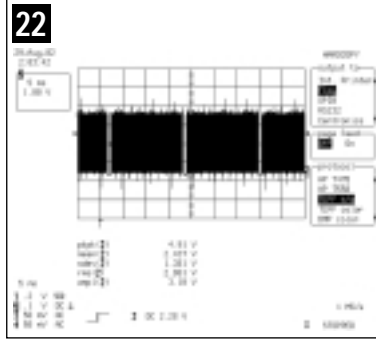
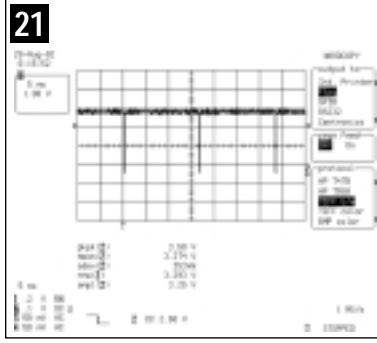
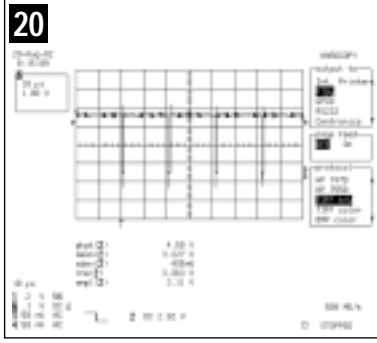
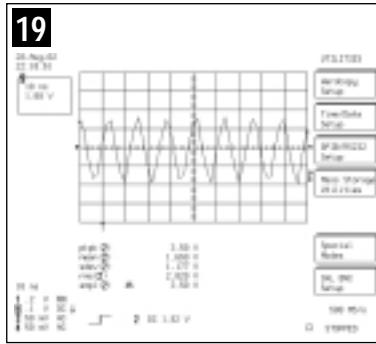
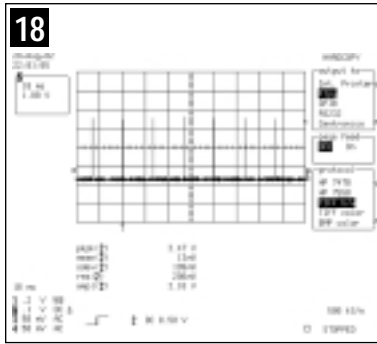
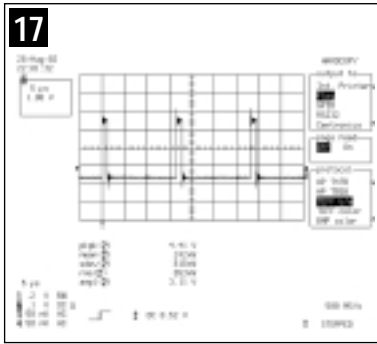

### 4-1-7 No Picture (PC Digital)

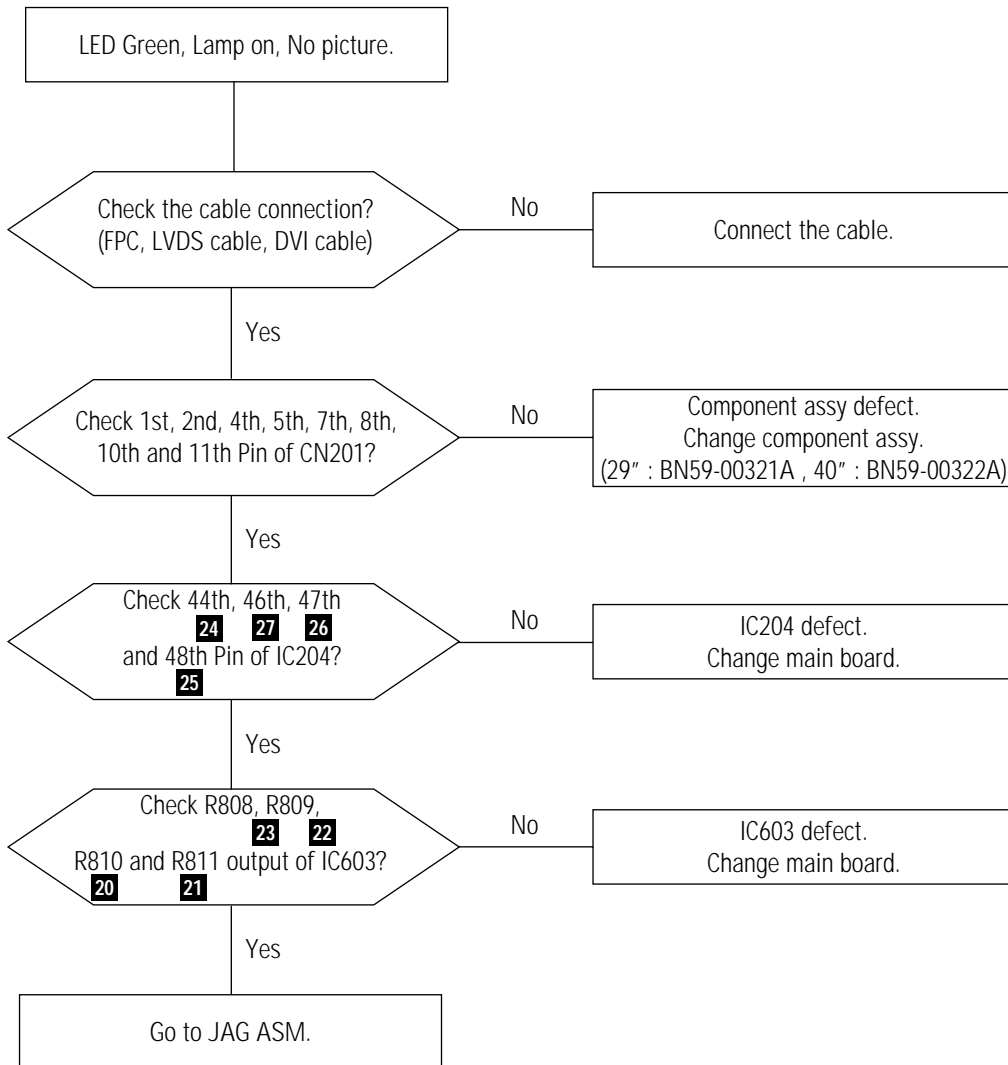

WAVEFORMS

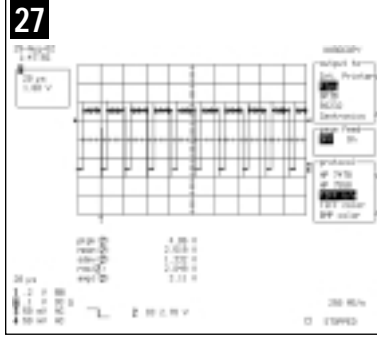
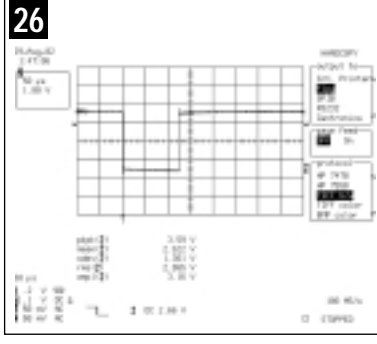
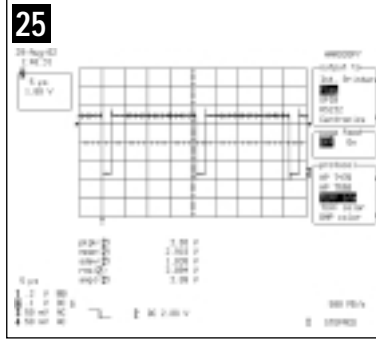
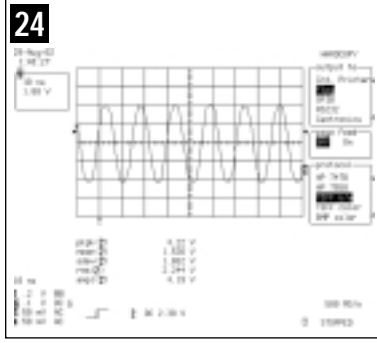
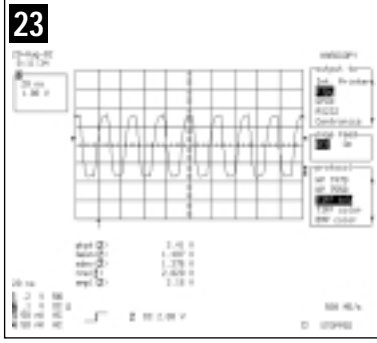
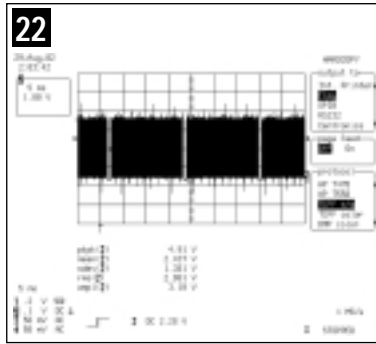
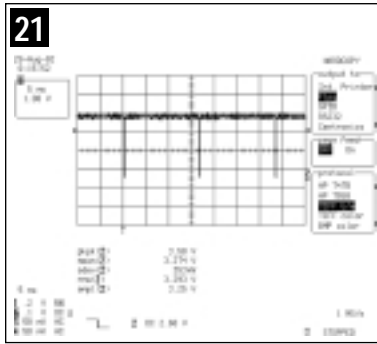
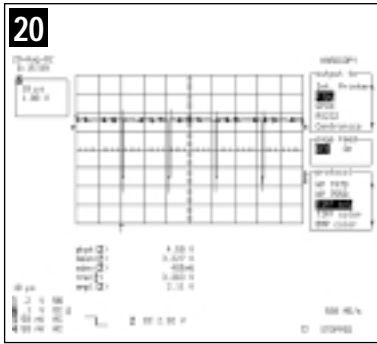

**4-2 JAG ASM**

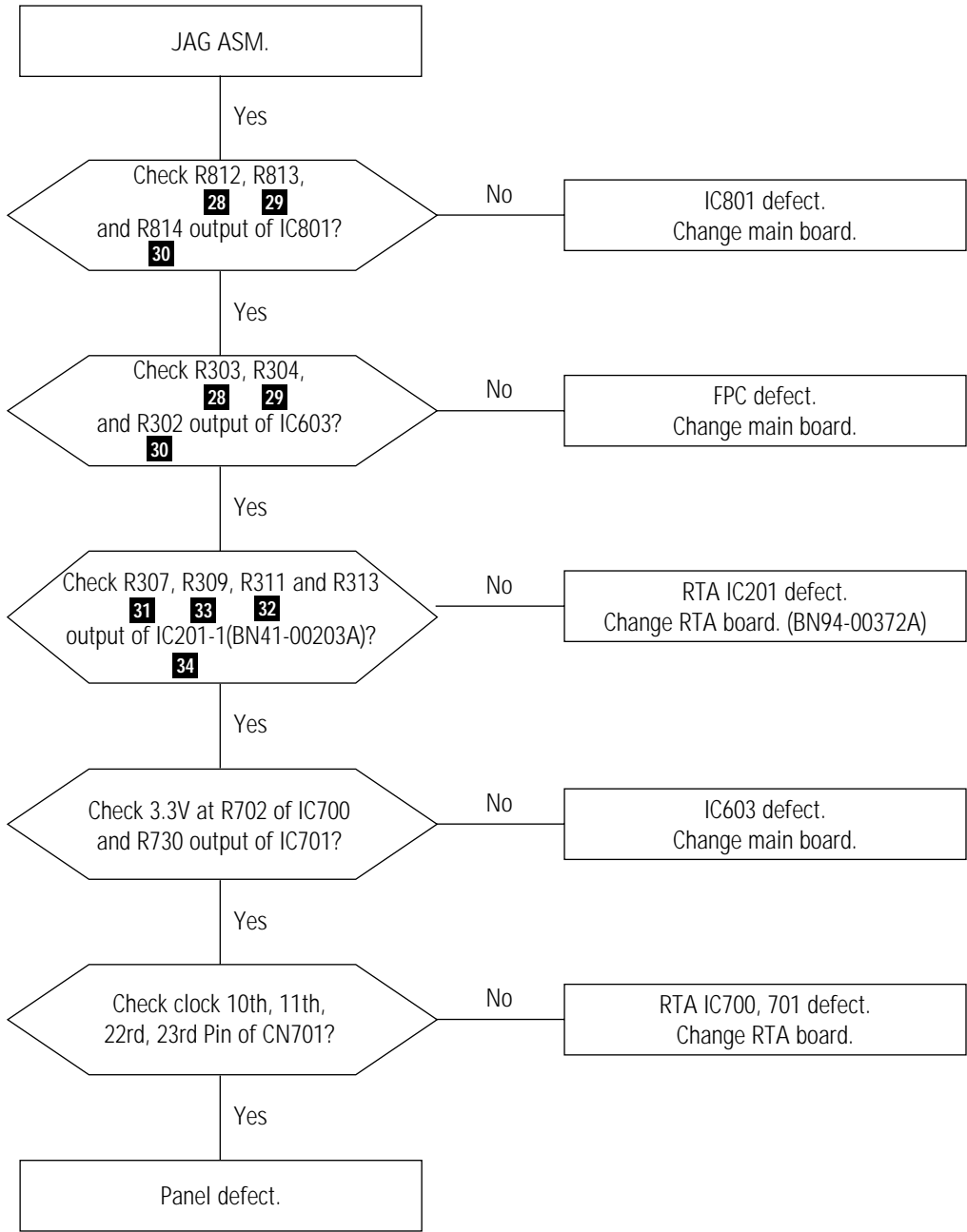

**WAVEFORMS**

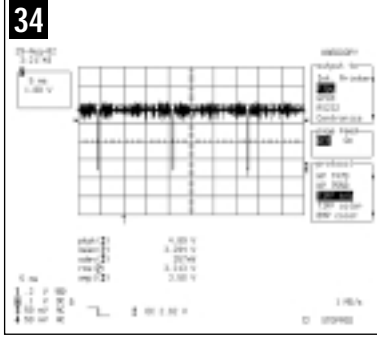
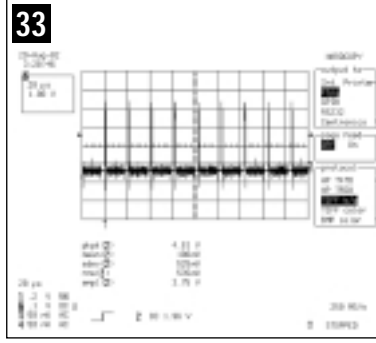
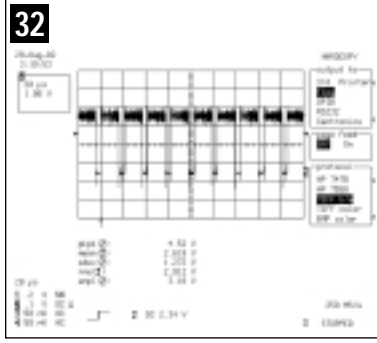
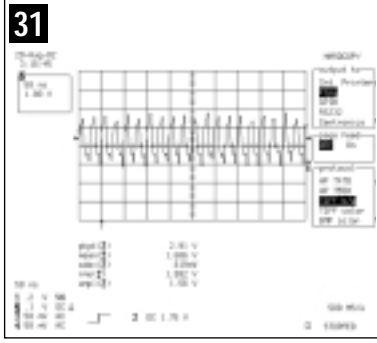
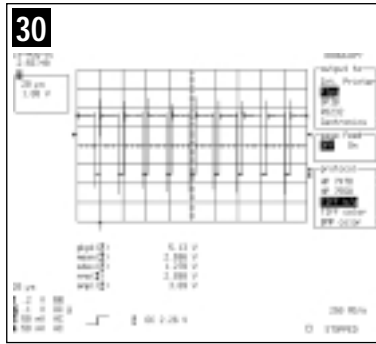
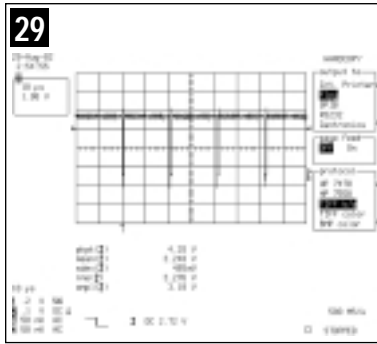
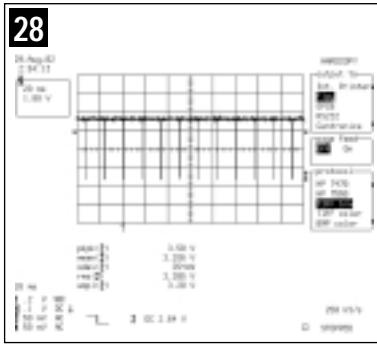

**4-3 No Sound**

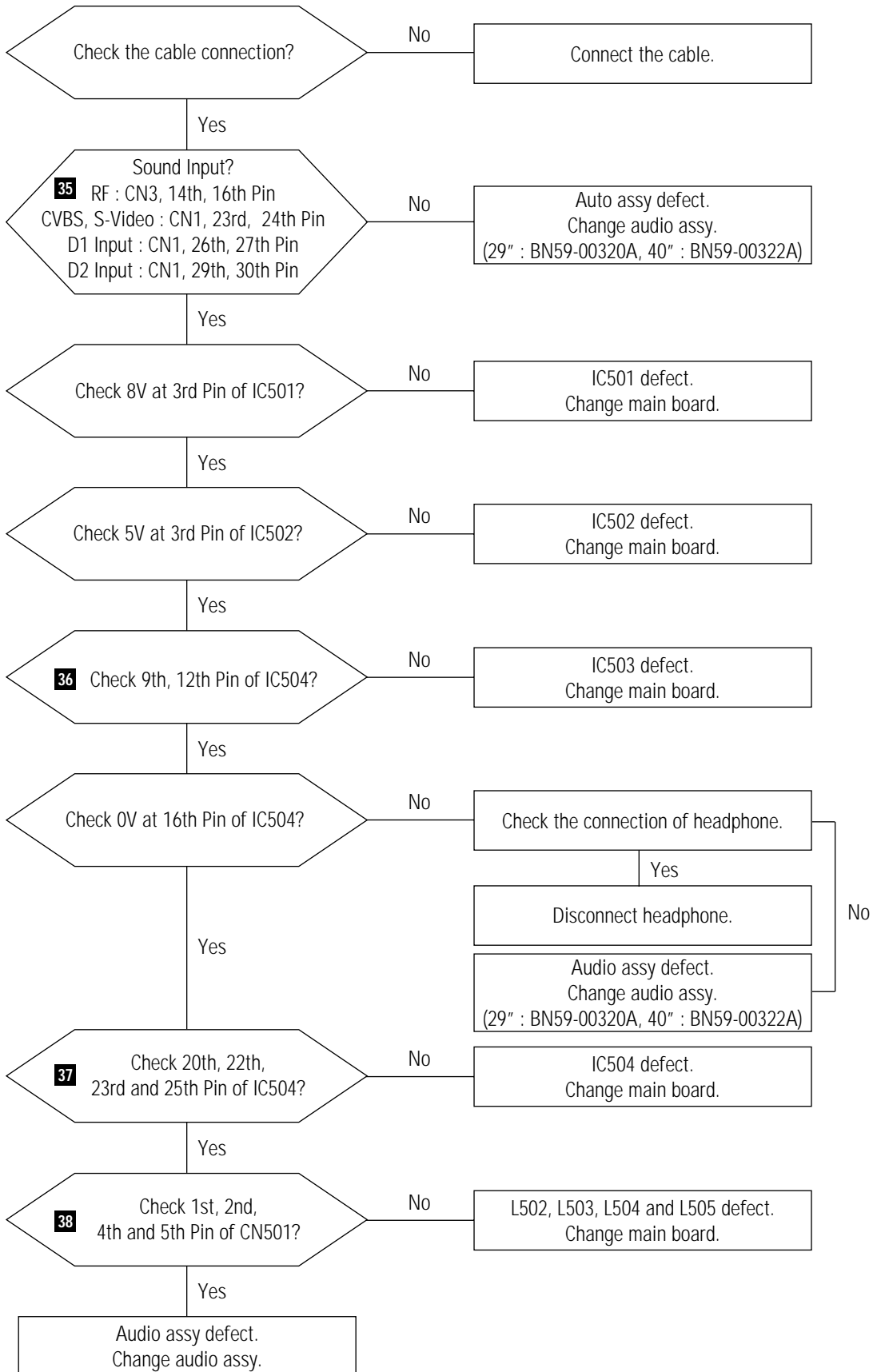



**WAVEFORMS**

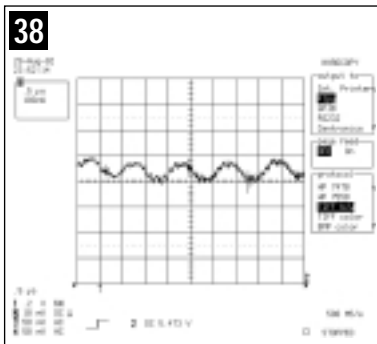
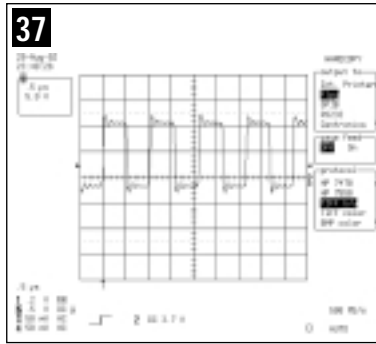
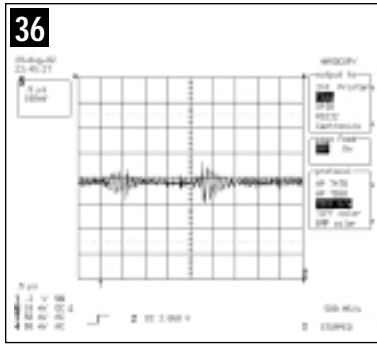
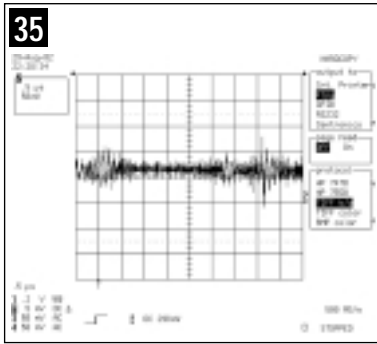

# Memo

5 Exploded View and Parts List

5-1 LT29A13W

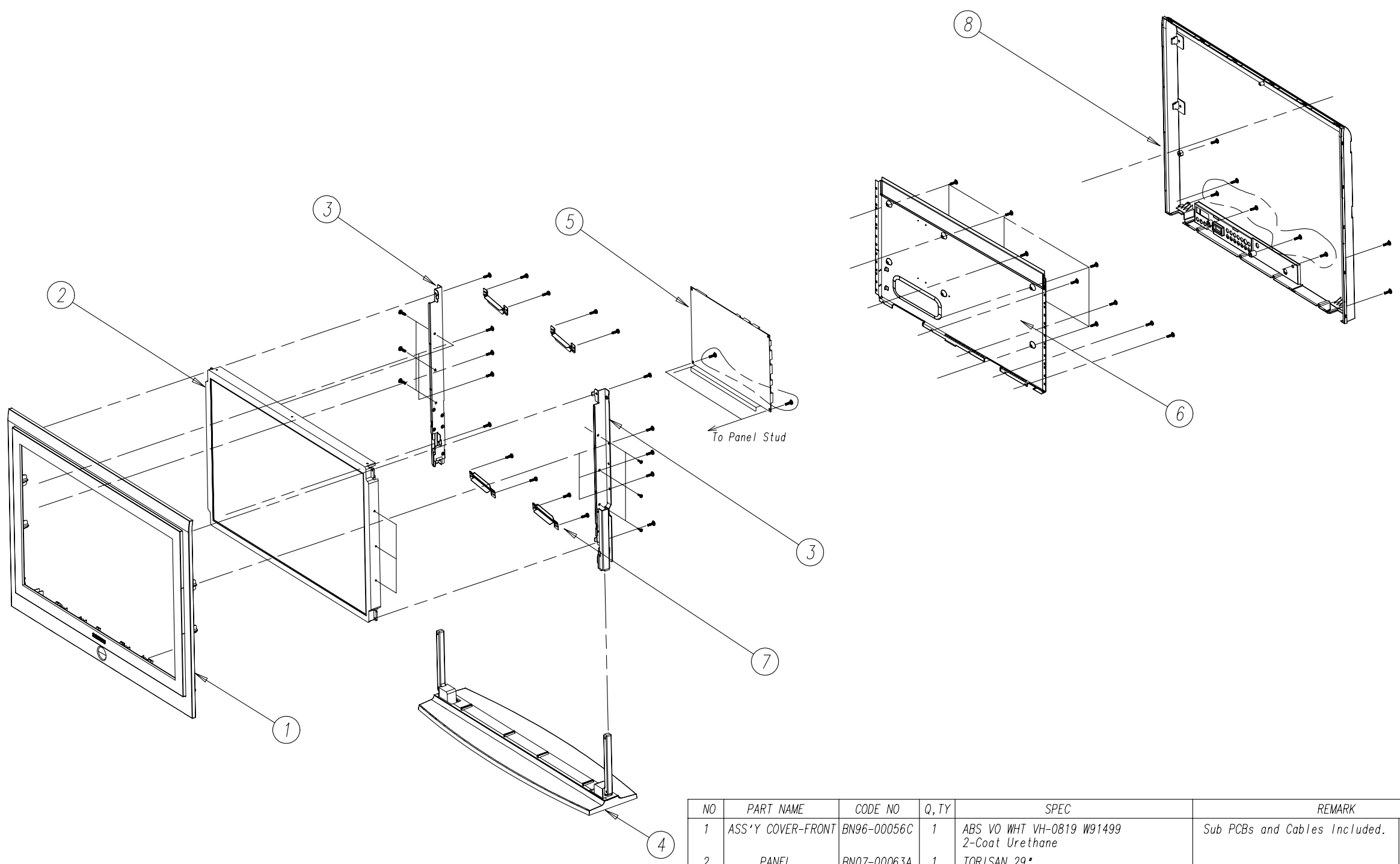

\* Refer to the drawing for the detail sub parts of the assembled part.

NO	PART NAME	CODE NO	Q, TY	SPEC	REMARK
1	ASS'Y COVER-FRONT	BN96-00056C	1	ABS VO WHT VH-0819 W91499 2-Coat Urethane	Sub PCBs and Cables Included. SA
2	PANEL	BN07-00063A	1	TORISAN 29"	SA
3	ASSY PANEL BRKT	BN96-00060A	1	SECC T1.6	SNA
4	ASSY STAND	BN96-00054B	1	ABS HB BK12 SPRAY : DGM1188	SA
5	MAIN PCB ASSY	-	1		SA
6	ASSY SHIELD PCB	BN63-00408C	1	SECC T0.5	SNA
7	BRKT PANEL	BN70-00192A	4	SPTF T0.5	SNA
8	REAR COVER	BN63-00232C	1	ABS VO IV16	SNA

5-2 LT40A13W

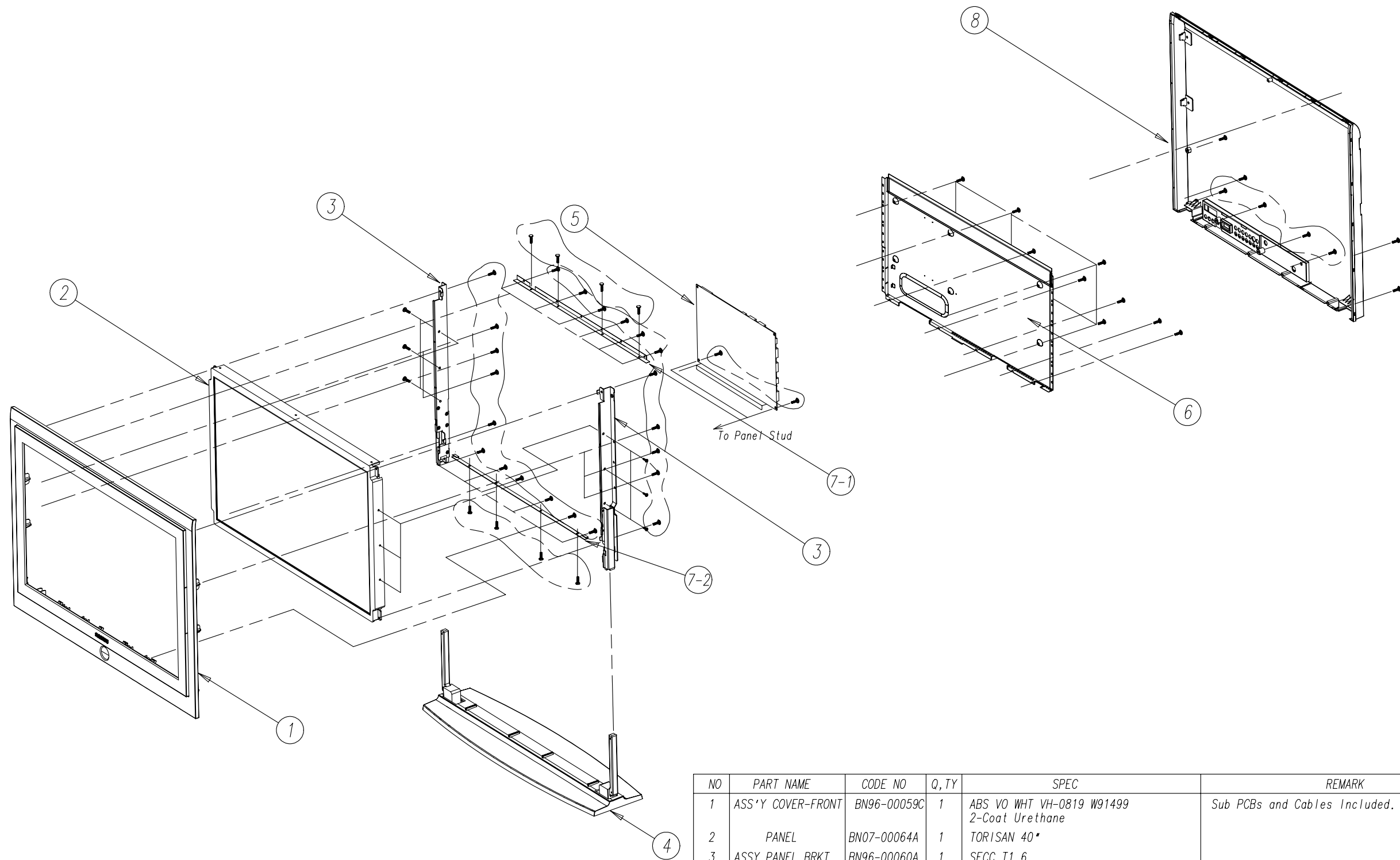

\* Refer to the drawing for the detail sub parts of the assembled part.

NO	PART NAME	CODE NO	Q, TY	SPEC	REMARK	
1	ASS'Y COVER-FRONT	BN96-00059C	1	ABS VO WHT VH-0819 W91499 2-Coat Urethane	Sub PCBs and Cables Included.	SA
2	PANEL	BN07-00064A	1	TORISAN 40"		SA
3	ASSY PANEL BRKT	BN96-00060A	1	SECC T1.6		SNA
4	ASSY STAND		1	ABS HB BK12 SPRAY : DGM1188		SA
5	MAIN PCB ASSY	-	1			SA
6	ASSY SHIELD PCB	BN96-00093A	1	SECC T0.5		SNA
7-1	BRKT PANEL TOP	BN61-00111A	1	SPTe T0.5		SNA
7-2	BRKT PANEL BOTTOM	BN61-00112A	1	SPTe T0.5		SNA
8	REAR COVER	BN63-00244A	1	ABS VO IV16		SNA

## 6 Electrical Parts List

### 6-1-1 LT29A13W Main PCB Parts

Loc. No.	Code No.	Description	Specification	Remarks
-	BN94-00362A	ASSY PCB MAIN	AL29JO	SNA
CIS01	6001-000677	SCREW-MACHINE	RH,+ M3,L6,ZPC(YEL),SM20C,-	SNA
CIS04	0202-001044	SOLDER-WIRE	S63S-W3.0,S63S,D3,63Sn/37Pb,-	SNA
CIS05	0202-001162	SOLDER-CREAM	RMA-20-21L,S63,-,SN63/PB36.6/AG0.4,FLUX9.5%	SNA
CIS06	0202-001172	SOLDER-WIRE FLUX	RS-107,RS60,D1.2,SN60/PB40,-	SNA
CIS07	0204-001096	ETHANOL	ISO-PROPYLENE,C2H5OH,99.8%,-	SNA
CIS08	0204-001527	FLUX	DF-201TVS,MIX,0.820,FLUX 13%, 14KG	SNA
CIS99	BN73-00025A	RUBBER CUSHION	AL29NO,CR,10*15,60,T4,BLACK,3M #9448	SNA
CN2	3711-004261	CONNECTOR-HEADER	BOX,12P,1R,2MM,ANGLE,SN	SNA
CN501	3711-004123	CONNECTOR-HEADER	BOX,15P,1R,2mm,ANGLE,SN	SNA
CN950	3711-003846	CONNECTOR-HEADER	BOX,8P,1R,2mm,ANGLE,SN	SNA
IC1	1001-001037	IC-RF/VI/AUDIO S/W	TA8851CN,-,DIP,54P,600MIL,SING	
L901	BN27-00012A	COIL CHOKE	5UH,APPOLO,5UH,10%,0.01OHM MAX,10A,PEI3210S,1T,40X70X25MM,BK,-10CTO+85C	
X102	2801-003224	CRYSTAL-UNIT	32.768KHz,20ppm,28-AAAY,12.5pF,	
CIS02	BN96-00093A	ASSY MISC P-SHIELD/D-SUB	AL29NO,SPTE T0.5	SNA
CIS03	BN97-00115W	ASSY MICOM	AL29JO	
IC105	1102-001108	IC-EPR0M	27C020,256Kx8Bit,PLCC,32P,495MIL,70nS,5V,10%,PLASTIC,0to+70C,100uA,CMOS,TR	SNA
CIS	BN46-00014R	S/W MICOM-S/W	AL29JO	SNA
-	BN97-00150A	ASSY SMD	AL29JO	SNA
BD1	2703-001334	INDUCTOR-SMD	1.5uH,10%,2x1.25x0.85mm	
BD2	2703-001334	INDUCTOR-SMD	1.5uH,10%,2x1.25x0.85mm	
BD201	3301-001176	CORE-FERRITE BEAD	AB,2x1.25x0.9mm,-,-	
BD202	3301-001176	CORE-FERRITE BEAD	AB,2x1.25x0.9mm,-,-	
BD203	3301-001176	CORE-FERRITE BEAD	AB,2x1.25x0.9mm,-,-	
BD3	2703-001334	INDUCTOR-SMD	1.5uH,10%,2x1.25x0.85mm	
BD301	3301-001176	CORE-FERRITE BEAD	AB,2x1.25x0.9mm,-,-	
BD302	3301-001176	CORE-FERRITE BEAD	AB,2x1.25x0.9mm,-,-	
BD303	3301-001176	CORE-FERRITE BEAD	AB,2x1.25x0.9mm,-,-	
BD304	3301-001176	CORE-FERRITE BEAD	AB,2x1.25x0.9mm,-,-	
BD4	2703-001334	INDUCTOR-SMD	1.5uH,10%,2x1.25x0.85mm	
BD401	3301-001176	CORE-FERRITE BEAD	AB,2x1.25x0.9mm,-,-	
BD402	3301-001176	CORE-FERRITE BEAD	AB,2x1.25x0.9mm,-,-	
BD403	3301-001176	CORE-FERRITE BEAD	AB,2x1.25x0.9mm,-,-	
BD404	3301-001176	CORE-FERRITE BEAD	AB,2x1.25x0.9mm,-,-	
BD405	3301-001176	CORE-FERRITE BEAD	AB,2x1.25x0.9mm,-,-	
BD406	3301-001176	CORE-FERRITE BEAD	AB,2x1.25x0.9mm,-,-	
BD407	3301-001176	CORE-FERRITE BEAD	AB,2x1.25x0.9mm,-,-	
BD501	3301-001145	CORE-FERRITE BEAD	AB,4.5x1.6x1.6mm,-,-	SNA
C1	2409-001065	C-ORGANIC	82UF,20%,16V,WT,TP,8X6.9MM,-	
C10	2402-001155	C-AL,SMD	47UF,20%,16V,WT,TP,6.3X5.2MM	
C1001	2402-001044	C-AL,SMD	100UF,20%,25V,GP,TP,8.3X8.3X6.3MM	
C1002	2203-000257	C-CERAMIC,CHIP	10nF,10%,50V,X7R,TP,1608	
C1003	2203-000189	C-CERAMIC,CHIP	100nF,+80-20%,25V,Y5V,TP,1608,	
C1004	2203-005137	C-CERAMIC,CHIP	10uF,+80-20%,50V,JE,TP,5650,-	
C1005	2203-005137	C-CERAMIC,CHIP	10uF,+80-20%,50V,JE,TP,5650,-	
C1006	2203-005005	C-CERAMIC,CHIP	100nF,10%,16V,X7R,TP,1608	
C1007	2203-005005	C-CERAMIC,CHIP	100nF,10%,16V,X7R,TP,1608	
C1008	2203-005005	C-CERAMIC,CHIP	100nF,10%,16V,X7R,TP,1608	
C1009	2409-001035	C-ORGANIC	10uF,20%,10V,LZ,TP,5.4x4.3x4.3mm,1	
C101	2203-000189	C-CERAMIC,CHIP	100nF,+80-20%,25V,Y5V,TP,1608,	
C1010	2402-000176	C-AL,SMD	10uF,20%,16V,GP,TP,4.3x4.3x5.4	
C1011	2402-000176	C-AL,SMD	10uF,20%,16V,GP,TP,4.3x4.3x5.4	
C1012	2203-005005	C-CERAMIC,CHIP	100nF,10%,16V,X7R,TP,1608	
C1013	2203-000257	C-CERAMIC,CHIP	10nF,10%,50V,X7R,TP,1608	
C1014	2203-005005	C-CERAMIC,CHIP	1000nF,+80-20%,10V,Y5V,TP,1608	
C1015	2203-001851	C-CERAMIC,CHIP	0.016nF,5%,50V,NPO,TP,1608	
C1016	2203-001652	C-CERAMIC,CHIP	470nF,+80-20%,16V,Y5V,TP,1608	
C1017	2203-001652	C-CERAMIC,CHIP	470nF,+80-20%,16V,Y5V,TP,1608	
C1018	2203-001652	C-CERAMIC,CHIP	470nF,+80-20%,16V,Y5V,TP,1608	
C1019	2203-001652	C-CERAMIC,CHIP	470nF,+80-20%,16V,Y5V,TP,1608	
C102	2203-000189	C-CERAMIC,CHIP	100nF,+80-20%,25V,Y5V,TP,1608,	
C1020	2203-001652	C-CERAMIC,CHIP	470nF,+80-20%,16V,Y5V,TP,1608	
C1021	2203-001652	C-CERAMIC,CHIP	470nF,+80-20%,16V,Y5V,TP,1608	
C1022	2203-001652	C-CERAMIC,CHIP	470nF,+80-20%,16V,Y5V,TP,1608	
C1023	2203-001652	C-CERAMIC,CHIP	470nF,+80-20%,16V,Y5V,TP,1608	

Loc. No.	Code No.	Description	Specification	Remarks
C1024	2203-001652	C-CERAMIC,CHIP	470nF,+80-20%,16V,Y5V,TP,1608	
C1025	2203-001652	C-CERAMIC,CHIP	470nF,+80-20%,16V,Y5V,TP,1608	
C1026	2203-001652	C-CERAMIC,CHIP	470nF,+80-20%,16V,Y5V,TP,1608	
C1027	2203-001652	C-CERAMIC,CHIP	470nF,+80-20%,16V,Y5V,TP,1608	
C1028	2203-001652	C-CERAMIC,CHIP	470nF,+80-20%,16V,Y5V,TP,1608	
C1029	2203-001652	C-CERAMIC,CHIP	470nF,+80-20%,16V,Y5V,TP,1608	
C103	2203-000189	C-CERAMIC,CHIP	100nF,+80-20%,25V,Y5V,TP,1608	
C1030	2203-001652	C-CERAMIC,CHIP	470nF,+80-20%,16V,Y5V,TP,1608	
C1031	2203-001652	C-CERAMIC,CHIP	470nF,+80-20%,16V,Y5V,TP,1608	
C104	2203-000189	C-CERAMIC,CHIP	100nF,+80-20%,25V,Y5V,TP,1608	
C105	2203-000189	C-CERAMIC,CHIP	100nF,+80-20%,25V,Y5V,TP,1608	
C106	2203-000189	C-CERAMIC,CHIP	100nF,+80-20%,25V,Y5V,TP,1608	
C107	2203-000815	C-CERAMIC,CHIP	0.033nF,5%,50V,NP0,TP,1608	
C108	2203-000815	C-CERAMIC,CHIP	0.033nF,5%,50V,NP0,TP,1608	
C109	2203-000189	C-CERAMIC,CHIP	100nF,+80-20%,25V,Y5V,TP,1608	
C11	2402-000170	C-AL,SMD	1uF,20%,50V,GP,TP,4.3x4.3x5.4	
C111	2203-000189	C-CERAMIC,CHIP	100nF,+80-20%,25V,Y5V,TP,1608	
C112	2203-000189	C-CERAMIC,CHIP	100nF,+80-20%,25V,Y5V,TP,1608	
C113	2203-000189	C-CERAMIC,CHIP	100nF,+80-20%,25V,Y5V,TP,1608	
C114	2203-000189	C-CERAMIC,CHIP	100nF,+80-20%,25V,Y5V,TP,1608	
C115	2203-000552	C-CERAMIC,CHIP	0.02nF,5%,50V,NP0,TP,1608	
C12	2402-000176	C-AL,SMD	10uF,20%,16V,GP,TP,4.3x4.3x5.4	
C13	2203-000440	C-CERAMIC,CHIP	1nF,10%,50V,X7R,TP,1608,-	
C14	2402-000170	C-AL,SMD	1uF,20%,50V,GP,TP,4.3x4.3x5.4	
C15	2203-000236	C-CERAMIC,CHIP	0.1nF,5%,50V,NP0,TP,1608	
C16	2203-000236	C-CERAMIC,CHIP	0.1nF,5%,50V,NP0,TP,1608	
C17	2203-000189	C-CERAMIC,CHIP	100nF,+80-20%,25V,Y5V,TP,1608	
C18	2203-000189	C-CERAMIC,CHIP	100nF,+80-20%,25V,Y5V,TP,1608	
C19	2402-000209	C-AL,SMD	22uF,20%,16V,WT,TP,5.3x5.3mm,1	
C2	2203-000189	C-CERAMIC,CHIP	100nF,+80-20%,25V,Y5V,TP,1608	
C20	2402-000209	C-AL,SMD	22uF,20%,16V,WT,TP,5.3x5.3mm,1	
C201	2409-001035	C-ORGANIC	10uF,20%,10V,LZ,TP,5.4x4.3x4.3mm,1	
C202	2203-005005	C-CERAMIC,CHIP	100nF,10%,16V,X7R,TP,1608	
C203	2203-005005	C-CERAMIC,CHIP	100nF,10%,16V,X7R,TP,1608	
C204	2203-005005	C-CERAMIC,CHIP	100nF,10%,16V,X7R,TP,1608	
C205	2203-005005	C-CERAMIC,CHIP	100nF,10%,16V,X7R,TP,1608	
C206	2203-005005	C-CERAMIC,CHIP	100nF,10%,16V,X7R,TP,1608	
C207	2409-001035	C-ORGANIC	10uF,20%,10V,LZ,TP,5.4x4.3x4.3mm,1	
C208	2203-005005	C-CERAMIC,CHIP	100nF,10%,16V,X7R,TP,1608	
C209	2203-005005	C-CERAMIC,CHIP	100nF,10%,16V,X7R,TP,1608	
C210	2203-005005	C-CERAMIC,CHIP	100nF,10%,16V,X7R,TP,1608	
C211	2203-005005	C-CERAMIC,CHIP	100nF,10%,16V,X7R,TP,1608	
C212	2203-005005	C-CERAMIC,CHIP	100nF,10%,16V,X7R,TP,1608	
C213	2203-005005	C-CERAMIC,CHIP	100nF,10%,16V,X7R,TP,1608	
C214	2203-005005	C-CERAMIC,CHIP	100nF,10%,16V,X7R,TP,1608	
C215	2203-005005	C-CERAMIC,CHIP	100nF,10%,16V,X7R,TP,1608	
C216	2203-005005	C-CERAMIC,CHIP	100nF,10%,16V,X7R,TP,1608	
C217	2203-000189	C-CERAMIC,CHIP	100nF,+80-20%,25V,Y5V,TP,1608	
C218	2203-000189	C-CERAMIC,CHIP	100nF,+80-20%,25V,Y5V,TP,1608	
C219	2402-000176	C-AL,SMD	10uF,20%,16V,GP,TP,4.3x4.3x5.4	
C22	2203-000257	C-CERAMIC,CHIP	10nF,10%,50V,X7R,TP,1608	
C220	2203-005005	C-CERAMIC,CHIP	100nF,10%,16V,X7R,TP,1608	
C221	2203-005005	C-CERAMIC,CHIP	100nF,10%,16V,X7R,TP,1608	
C222	2203-005005	C-CERAMIC,CHIP	100nF,10%,16V,X7R,TP,1608	
C223	2203-005005	C-CERAMIC,CHIP	100nF,10%,16V,X7R,TP,1608	
C224	2203-005005	C-CERAMIC,CHIP	100nF,10%,16V,X7R,TP,1608	
C225	2402-000108	C-AL,SMD	10uF,20%,16V,WT,TP,4.3x4.3x5.4	
C226	2203-000440	C-CERAMIC,CHIP	1nF,10%,50V,X7R,TP,1608,-	
C227	2203-000440	C-CERAMIC,CHIP	1nF,10%,50V,X7R,TP,1608,-	
C228	2203-000384	C-CERAMIC,CHIP	0.015nF,5%,50V,NP0,TP,1608	
C229	2203-005005	C-CERAMIC,CHIP	100nF,10%,16V,X7R,TP,1608	
C23	2203-000189	C-CERAMIC,CHIP	100nF,+80-20%,25V,Y5V,TP,1608	
C230	2203-000440	C-CERAMIC,CHIP	1nF,10%,50V,X7R,TP,1608,-	
C231	2203-005005	C-CERAMIC,CHIP	100nF,10%,16V,X7R,TP,1608	
C232	2203-000843	C-CERAMIC,CHIP	39nF,10%,25V,X7R,TP,1608,-	
C233	2203-000726	C-CERAMIC,CHIP	3.9nF,10%,50V,X7R,TP,1608,-	
C234	2203-000972	C-CERAMIC,CHIP	47nF,10%,16V,X7R,TP,1608	
C235	2203-000972	C-CERAMIC,CHIP	47nF,10%,16V,X7R,TP,1608	
C236	2203-000972	C-CERAMIC,CHIP	47nF,10%,16V,X7R,TP,1608	
C237	2402-000176	C-AL,SMD	10uF,20%,16V,GP,TP,4.3x4.3x5.4	
C238	2203-005005	C-CERAMIC,CHIP	100nF,10%,16V,X7R,TP,1608	

Loc. No.	Code No.	Description	Specification	Remarks
C239	2203-005005	C-CERAMIC,CHIP	100nF,10%,16V,X7R,TP,1608	
C24	2203-000189	C-CERAMIC,CHIP	100nF,+80-20%,25V,Y5V,TP,1608,	
C240	2203-005005	C-CERAMIC,CHIP	100nF,10%,16V,X7R,TP,1608	
C241	2203-005005	C-CERAMIC,CHIP	100nF,10%,16V,X7R,TP,1608	
C242	2203-005005	C-CERAMIC,CHIP	100nF,10%,16V,X7R,TP,1608	
C243	2402-000176	C-AL,SMD	10uF,20%,16V,GP,TP,4.3x4.3x5.4	
C244	2203-005005	C-CERAMIC,CHIP	100nF,10%,16V,X7R,TP,1608	
C245	2203-005005	C-CERAMIC,CHIP	100nF,10%,16V,X7R,TP,1608	
C246	2203-005005	C-CERAMIC,CHIP	100nF,10%,16V,X7R,TP,1608	
C247	2402-000176	C-AL,SMD	10uF,20%,16V,GP,TP,4.3x4.3x5.4	
C248	2409-001035	C-ORGANIC	10uF,20%,10V,LZ,TP,5.4x4.3x4.3mm,1	
C249	2203-005005	C-CERAMIC,CHIP	100nF,10%,16V,X7R,TP,1608	
C25	2203-000357	C-CERAMIC,CHIP	0.15nF,5%,50V,NPO,TP,1608	
C250	2203-005005	C-CERAMIC,CHIP	100nF,10%,16V,X7R,TP,1608	
C251	2203-005005	C-CERAMIC,CHIP	100nF,10%,16V,X7R,TP,1608	
C252	2203-005005	C-CERAMIC,CHIP	100nF,10%,16V,X7R,TP,1608	
C253	2203-005005	C-CERAMIC,CHIP	100nF,10%,16V,X7R,TP,1608	
C254	2203-000189	C-CERAMIC,CHIP	100nF,+80-20%,25V,Y5V,TP,1608,	
C255	2203-000189	C-CERAMIC,CHIP	100nF,+80-20%,25V,Y5V,TP,1608,	
C256	2203-000189	C-CERAMIC,CHIP	100nF,+80-20%,25V,Y5V,TP,1608,	
C257	2203-000257	C-CERAMIC,CHIP	10nF,10%,50V,X7R,TP,1608	
C258	2203-000440	C-CERAMIC,CHIP	1nF,10%,50V,X7R,TP,1608,-	
C26	2203-000357	C-CERAMIC,CHIP	0.15nF,5%,50V,NPO,TP,1608	
C260	2402-000176	C-AL,SMD	10uF,20%,16V,GP,TP,4.3x4.3x5.4	
C261	2203-005005	C-CERAMIC,CHIP	100nF,10%,16V,X7R,TP,1608	
C262	2203-005005	C-CERAMIC,CHIP	100nF,10%,16V,X7R,TP,1608	
C263	2203-005005	C-CERAMIC,CHIP	100nF,10%,16V,X7R,TP,1608	
C264	2203-005005	C-CERAMIC,CHIP	100nF,10%,16V,X7R,TP,1608	
C265	2203-005005	C-CERAMIC,CHIP	100nF,10%,16V,X7R,TP,1608	
C266	2203-000440	C-CERAMIC,CHIP	1nF,10%,50V,X7R,TP,1608,-	
C267	2203-000440	C-CERAMIC,CHIP	1nF,10%,50V,X7R,TP,1608,-	
C268	2203-000440	C-CERAMIC,CHIP	1nF,10%,50V,X7R,TP,1608,-	
C269	2203-000440	C-CERAMIC,CHIP	1nF,10%,50V,X7R,TP,1608,-	
C27	2402-001155	C-AL,SMD	47uF,20%,16V,WT,TP,6.3x5.2MM	
C272	2203-000384	C-CERAMIC,CHIP	0.015nF,5%,50V,NPO,TP,1608	
C28	2203-000626	C-CERAMIC,CHIP	0.022nF,5%,50V,NPO,TP,1608	
C29	2203-000189	C-CERAMIC,CHIP	100nF,+80-20%,25V,Y5V,TP,1608,	
C299	2402-001044	C-AL,SMD	100uF,20%,25V,GP,TP,8.3x8.3x6.3MM	
C3	2402-000176	C-AL,SMD	10uF,20%,16V,GP,TP,4.3x4.3x5.4	
C30	2203-000189	C-CERAMIC,CHIP	100nF,+80-20%,25V,Y5V,TP,1608,	
C301	2203-000626	C-CERAMIC,CHIP	0.022nF,5%,50V,NPO,TP,1608	
C302	2409-001065	C-ORGANIC	82uF,20%,16V,WT,TP,8X6.9MM,-	
C303	2402-000176	C-AL,SMD	10uF,20%,16V,GP,TP,4.3x4.3x5.4	
C304	2203-000626	C-CERAMIC,CHIP	0.022nF,5%,50V,NPO,TP,1608	
C305	2203-005065	C-CERAMIC,CHIP	1000nF,+80-20%,10V,Y5V,TP,1608	
C306	2203-005065	C-CERAMIC,CHIP	1000nF,+80-20%,10V,Y5V,TP,1608	
C307	2203-005065	C-CERAMIC,CHIP	1000nF,+80-20%,10V,Y5V,TP,1608	
C308	2409-001029	C-ORGANIC	120uF,20%,6.3V,WT,TP,10.3x10.3x10.3mm,9	
C309	2203-005065	C-CERAMIC,CHIP	1000nF,+80-20%,10V,Y5V,TP,1608	
C31	2203-000626	C-CERAMIC,CHIP	0.022nF,5%,50V,NPO,TP,1608	
C310	2203-005065	C-CERAMIC,CHIP	1000nF,+80-20%,10V,Y5V,TP,1608	
C311	2409-001029	C-ORGANIC	120uF,20%,6.3V,WT,TP,10.3x10.3x10.3mm,9	
C312	2409-001029	C-ORGANIC	120uF,20%,6.3V,WT,TP,10.3x10.3x10.3mm,9	
C313	2203-005065	C-CERAMIC,CHIP	1000nF,+80-20%,10V,Y5V,TP,1608	
C314	2203-005065	C-CERAMIC,CHIP	1000nF,+80-20%,10V,Y5V,TP,1608	
C315	2203-005065	C-CERAMIC,CHIP	1000nF,+80-20%,10V,Y5V,TP,1608	
C316	2203-005065	C-CERAMIC,CHIP	1000nF,+80-20%,10V,Y5V,TP,1608	
C317	2203-005065	C-CERAMIC,CHIP	1000nF,+80-20%,10V,Y5V,TP,1608	
C318	2409-001029	C-ORGANIC	120uF,20%,6.3V,WT,TP,10.3x10.3x10.3mm,9	
C319	2409-001029	C-ORGANIC	120uF,20%,6.3V,WT,TP,10.3x10.3x10.3mm,9	
C32	2203-000189	C-CERAMIC,CHIP	100nF,+80-20%,25V,Y5V,TP,1608,	
C320	2203-005065	C-CERAMIC,CHIP	1000nF,+80-20%,10V,Y5V,TP,1608	
C321	2203-005065	C-CERAMIC,CHIP	1000nF,+80-20%,10V,Y5V,TP,1608	
C322	2203-005065	C-CERAMIC,CHIP	1000nF,+80-20%,10V,Y5V,TP,1608	
C323	2203-005065	C-CERAMIC,CHIP	1000nF,+80-20%,10V,Y5V,TP,1608	
C324	2203-000189	C-CERAMIC,CHIP	100nF,+80-20%,25V,Y5V,TP,1608,	
C325	2203-000189	C-CERAMIC,CHIP	100nF,+80-20%,25V,Y5V,TP,1608,	
C326	2203-000189	C-CERAMIC,CHIP	100nF,+80-20%,25V,Y5V,TP,1608,	
C327	2203-000189	C-CERAMIC,CHIP	100nF,+80-20%,25V,Y5V,TP,1608,	
C328	2203-000189	C-CERAMIC,CHIP	100nF,+80-20%,25V,Y5V,TP,1608,	

Loc. No.	Code No.	Description	Specification	Remarks
C329	2203-000189	C-CERAMIC,CHIP	100nF,+80-20%,25V,Y5V,TP,1608,	
C33	2203-000189	C-CERAMIC,CHIP	100nF,+80-20%,25V,Y5V,TP,1608,	
C330	2203-000189	C-CERAMIC,CHIP	100nF,+80-20%,25V,Y5V,TP,1608,	
C332	2203-000972	C-CERAMIC,CHIP	47nF,10%,16V,X7R,TP,1608	
C333	2203-000972	C-CERAMIC,CHIP	47nF,10%,16V,X7R,TP,1608	
C334	2203-000972	C-CERAMIC,CHIP	47nF,10%,16V,X7R,TP,1608	
C335	2203-000189	C-CERAMIC,CHIP	100nF,+80-20%,25V,Y5V,TP,1608,	
C336	2203-000972	C-CERAMIC,CHIP	47nF,10%,16V,X7R,TP,1608	
C337	2203-000972	C-CERAMIC,CHIP	47nF,10%,16V,X7R,TP,1608	
C339	2203-000784	C-CERAMIC,CHIP	0.33nF,5%,50V,NP0,TP,2012	
C34	2402-001155	C-AL,SMD	47UF,20%,16V,WT,TP,6.3X5.2MM	
C340	2203-000784	C-CERAMIC,CHIP	0.33nF,5%,50V,NP0,TP,2012	
C341	2203-000784	C-CERAMIC,CHIP	0.33nF,5%,50V,NP0,TP,2012	
C342	2203-000784	C-CERAMIC,CHIP	0.33nF,5%,50V,NP0,TP,2012	
C343	2203-000784	C-CERAMIC,CHIP	0.33nF,5%,50V,NP0,TP,2012	
C344	2203-000784	C-CERAMIC,CHIP	0.33nF,5%,50V,NP0,TP,2012	
C345	2402-000176	C-AL,SMD	10uF,20%,16V,GP,TP,4.3x4.3x5.4	
C346	2203-000189	C-CERAMIC,CHIP	100nF,+80-20%,25V,Y5V,TP,1608,	
C347	2203-000189	C-CERAMIC,CHIP	100nF,+80-20%,25V,Y5V,TP,1608,	
C348	2409-001029	C-ORGANIC	120uF,20%,6.3V,WT,TP,10.3x10.3x10.3mm,9	
C349	2203-000257	C-CERAMIC,CHIP	10nF,10%,50V,X7R,TP,1608	
C350	2203-000257	C-CERAMIC,CHIP	10nF,10%,50V,X7R,TP,1608	
C351	2203-000257	C-CERAMIC,CHIP	10nF,10%,50V,X7R,TP,1608	
C352	2203-001656	C-CERAMIC,CHIP	0.47nF,5%,50V,NP0,TP,1608	
C353	2203-000257	C-CERAMIC,CHIP	10nF,10%,50V,X7R,TP,1608	
C354	2402-001155	C-AL,SMD	47UF,20%,16V,WT,TP,6.3X5.2MM	
C355	2402-001155	C-AL,SMD	47UF,20%,16V,WT,TP,6.3X5.2MM	
C356	2402-001155	C-AL,SMD	47UF,20%,16V,WT,TP,6.3X5.2MM	
C36	2402-000170	C-AL,SMD	1uF,20%,50V,GP,TP,4.3x4.3x5.4,	
C37	2203-000189	C-CERAMIC,CHIP	100nF,+80-20%,25V,Y5V,TP,1608,	
C370	2402-001155	C-AL,SMD	47UF,20%,16V,WT,TP,6.3X5.2MM	
C371	2402-001155	C-AL,SMD	47UF,20%,16V,WT,TP,6.3X5.2MM	
C372	2402-001155	C-AL,SMD	47UF,20%,16V,WT,TP,6.3X5.2MM	
C374	2203-000257	C-CERAMIC,CHIP	10nF,10%,50V,X7R,TP,1608	
C375	2203-000257	C-CERAMIC,CHIP	10nF,10%,50V,X7R,TP,1608	
C376	2203-000257	C-CERAMIC,CHIP	10nF,10%,50V,X7R,TP,1608	
C38	2203-000189	C-CERAMIC,CHIP	100nF,+80-20%,25V,Y5V,TP,1608,	
C4	2402-000176	C-AL,SMD	10uF,20%,16V,GP,TP,4.3x4.3x5.4	
C40	2203-000189	C-CERAMIC,CHIP	100nF,+80-20%,25V,Y5V,TP,1608,	
C401	2409-001035	C-ORGANIC	10uF,20%,10V,LZ,TP,5.4x4.3x4.3mm,1	
C402	2409-001035	C-ORGANIC	10uF,20%,10V,LZ,TP,5.4x4.3x4.3mm,1	
C403	2402-000176	C-AL,SMD	10uF,20%,16V,GP,TP,4.3x4.3x5.4	
C404	2203-005005	C-CERAMIC,CHIP	100nF,10%,16V,X7R,TP,1608	
C405	2203-005005	C-CERAMIC,CHIP	100nF,10%,16V,X7R,TP,1608	
C406	2203-005005	C-CERAMIC,CHIP	100nF,10%,16V,X7R,TP,1608	
C407	2203-005005	C-CERAMIC,CHIP	100nF,10%,16V,X7R,TP,1608	
C408	2203-005005	C-CERAMIC,CHIP	100nF,10%,16V,X7R,TP,1608	
C409	2203-005005	C-CERAMIC,CHIP	100nF,10%,16V,X7R,TP,1608	
C41	2203-000189	C-CERAMIC,CHIP	100nF,+80-20%,25V,Y5V,TP,1608,	
C410	2203-005005	C-CERAMIC,CHIP	100nF,10%,16V,X7R,TP,1608	
C411	2203-005005	C-CERAMIC,CHIP	100nF,10%,16V,X7R,TP,1608	
C412	2203-005005	C-CERAMIC,CHIP	100nF,10%,16V,X7R,TP,1608	
C413	2203-005005	C-CERAMIC,CHIP	100nF,10%,16V,X7R,TP,1608	
C414	2203-005005	C-CERAMIC,CHIP	100nF,10%,16V,X7R,TP,1608	
C415	2203-005005	C-CERAMIC,CHIP	100nF,10%,16V,X7R,TP,1608	
C416	2203-005005	C-CERAMIC,CHIP	100nF,10%,16V,X7R,TP,1608	
C417	2203-005005	C-CERAMIC,CHIP	100nF,10%,16V,X7R,TP,1608	
C418	2203-005005	C-CERAMIC,CHIP	100nF,10%,16V,X7R,TP,1608	
C419	2203-005005	C-CERAMIC,CHIP	100nF,10%,16V,X7R,TP,1608	
C420	2203-005005	C-CERAMIC,CHIP	100nF,10%,16V,X7R,TP,1608	
C421	2203-005005	C-CERAMIC,CHIP	100nF,10%,16V,X7R,TP,1608	
C422	2203-005005	C-CERAMIC,CHIP	100nF,10%,16V,X7R,TP,1608	
C423	2203-000189	C-CERAMIC,CHIP	100nF,+80-20%,25V,Y5V,TP,1608,	
C424	2203-000189	C-CERAMIC,CHIP	100nF,+80-20%,25V,Y5V,TP,1608,	
C425	2402-000108	C-AL,SMD	10uF,20%,16V,WT,TP,4.3x4.3x5.4	
C426	2203-000440	C-CERAMIC,CHIP	1nF,10%,50V,X7R,TP,1608,-	
C427	2203-000440	C-CERAMIC,CHIP	1nF,10%,50V,X7R,TP,1608,-	
C428	2409-001029	C-ORGANIC	120uF,20%,6.3V,WT,TP,10.3x10.3x10.3mm,9	
C429	2203-000257	C-CERAMIC,CHIP	10nF,10%,50V,X7R,TP,1608	
C43	2203-000189	C-CERAMIC,CHIP	100nF,+80-20%,25V,Y5V,TP,1608,	
C430	2203-005005	C-CERAMIC,CHIP	100nF,10%,16V,X7R,TP,1608	



Loc. No.	Code No.	Description	Specification	Remarks
C431	2203-000257	C-CERAMIC,CHIP	10nF,10%,50V,X7R,TP,1608	
C432	2203-000257	C-CERAMIC,CHIP	10nF,10%,50V,X7R,TP,1608	
C433	2203-001656	C-CERAMIC,CHIP	0.47nF,5%,50V,NP0,TP,1608	
C434	2203-000257	C-CERAMIC,CHIP	10nF,10%,50V,X7R,TP,1608	
C435	2402-001155	C-AL,SMD	47UF,20%,16V,WT,TP,6.3X5.2MM	
C436	2402-001155	C-AL,SMD	47UF,20%,16V,WT,TP,6.3X5.2MM	
C437	2402-001155	C-AL,SMD	47UF,20%,16V,WT,TP,6.3X5.2MM	
C438	2203-000440	C-CERAMIC,CHIP	1nF,10%,50V,X7R,TP,1608,-	
C439	2203-000440	C-CERAMIC,CHIP	1nF,10%,50V,X7R,TP,1608,-	
C440	2203-000440	C-CERAMIC,CHIP	1nF,10%,50V,X7R,TP,1608,-	
C441	2203-000440	C-CERAMIC,CHIP	1nF,10%,50V,X7R,TP,1608,-	
C442	2203-000903	C-CERAMIC,CHIP	0.0047nF,0.25pF,50V,NP0,TP,1608	
C443	2203-000903	C-CERAMIC,CHIP	0.0047nF,0.25pF,50V,NP0,TP,1608	
C444	2203-000903	C-CERAMIC,CHIP	0.0047nF,0.25pF,50V,NP0,TP,1608	
C445	2402-001155	C-AL,SMD	47UF,20%,16V,WT,TP,6.3X5.2MM	
C446	2402-001155	C-AL,SMD	47UF,20%,16V,WT,TP,6.3X5.2MM	
C447	2402-001155	C-AL,SMD	47UF,20%,16V,WT,TP,6.3X5.2MM	
C448	2203-000257	C-CERAMIC,CHIP	10nF,10%,50V,X7R,TP,1608	
C449	2203-000257	C-CERAMIC,CHIP	10nF,10%,50V,X7R,TP,1608	
C45	2203-000189	C-CERAMIC,CHIP	100nF,+80-20%,25V,Y5V,TP,1608,	
C450	2203-000257	C-CERAMIC,CHIP	10nF,10%,50V,X7R,TP,1608	
C451	2203-005005	C-CERAMIC,CHIP	100nF,10%,16V,X7R,TP,1608	
C452	2203-000843	C-CERAMIC,CHIP	39nF,10%,25V,X7R,TP,1608,-	
C453	2203-000726	C-CERAMIC,CHIP	3.9nF,10%,50V,X7R,TP,1608,-	
C454	2203-000189	C-CERAMIC,CHIP	100nF,+80-20%,25V,Y5V,TP,1608,	
C455	2203-000189	C-CERAMIC,CHIP	100nF,+80-20%,25V,Y5V,TP,1608,	
C48	2402-000176	C-AL,SMD	10uF,20%,16V,GP,TP,4.3x4.3x5.4	
C49	2402-001155	C-AL,SMD	47UF,20%,16V,WT,TP,6.3X5.2MM	
C5	2402-000176	C-AL,SMD	10uF,20%,16V,GP,TP,4.3x4.3x5.4	
C501	2203-000189	C-CERAMIC,CHIP	100nF,+80-20%,25V,Y5V,TP,1608,	
C502	2402-000144	C-AL,SMD	3.3uF,20%,50V,GP,TP,4.3x4.3x5.	
C503	2402-000176	C-AL,SMD	10uF,20%,16V,GP,TP,4.3x4.3x5.4	
C504	2203-000189	C-CERAMIC,CHIP	100nF,+80-20%,25V,Y5V,TP,1608,	
C505	2203-001656	C-CERAMIC,CHIP	0.47nF,5%,50V,NP0,TP,1608	
C506	2203-000140	C-CERAMIC,CHIP	1.5nF,10%,50V,X7R,TP,1608,-	
C507	2402-001042	C-AL,SMD	100uF,20%,16V,GP,TP,6.6x6.6x5.4mm	
C508	2402-001155	C-AL,SMD	47UF,20%,16V,WT,TP,6.3X5.2MM	
C509	2402-001044	C-AL,SMD	100UF,20%,25V,GP,TP,8.3X8.3X6.3MM	
C51	2203-000189	C-CERAMIC,CHIP	100nF,+80-20%,25V,Y5V,TP,1608,	
C510	2203-005005	C-CERAMIC,CHIP	100nF,10%,16V,X7R,TP,1608	
C511	2402-001044	C-AL,SMD	100UF,20%,25V,GP,TP,8.3X8.3X6.3MM	
C512	2203-000257	C-CERAMIC,CHIP	10nF,10%,50V,X7R,TP,1608	
C513	2402-001044	C-AL,SMD	100UF,20%,25V,GP,TP,8.3X8.3X6.3MM	
C514	2203-000257	C-CERAMIC,CHIP	10nF,10%,50V,X7R,TP,1608	
C515	2402-000176	C-AL,SMD	10uF,20%,16V,GP,TP,4.3x4.3x5.4	
C516	2203-005005	C-CERAMIC,CHIP	100nF,10%,16V,X7R,TP,1608	
C517	2203-000140	C-CERAMIC,CHIP	1.5nF,10%,50V,X7R,TP,1608,-	
C518	2203-001656	C-CERAMIC,CHIP	0.47nF,5%,50V,NP0,TP,1608	
C519	2402-000176	C-AL,SMD	10uF,20%,16V,GP,TP,4.3x4.3x5.4	
C52	2203-000626	C-CERAMIC,CHIP	0.022nF,5%,50V,NP0,TP,1608	
C520	2402-000176	C-AL,SMD	10uF,20%,16V,GP,TP,4.3x4.3x5.4	
C521	2203-001077	C-CERAMIC,CHIP	0.056nF,5%,50V,NP0,TP,2012	
C522	2402-000176	C-AL,SMD	10uF,20%,16V,GP,TP,4.3x4.3x5.4	
C523	2203-001077	C-CERAMIC,CHIP	0.056nF,5%,50V,NP0,TP,2012	
C524	2402-000209	C-AL,SMD	22uF,20%,16V,WT,TP,5.3x5.3mm,1	
C525	2203-001077	C-CERAMIC,CHIP	0.056nF,5%,50V,NP0,TP,2012	
C526	2402-000209	C-AL,SMD	22uF,20%,16V,WT,TP,5.3x5.3mm,1	
C527	2402-000170	C-AL,SMD	1uF,20%,50V,GP,TP,4.3x4.3x5.4,	
C528	2203-000189	C-CERAMIC,CHIP	100nF,+80-20%,25V,Y5V,TP,1608,	
C529	2203-005015	C-CERAMIC,CHIP	150nF,+80-20%,16V,Y5V,TP,1608	
C53	2203-000626	C-CERAMIC,CHIP	0.022nF,5%,50V,NP0,TP,1608	
C530	2203-005015	C-CERAMIC,CHIP	150nF,+80-20%,16V,Y5V,TP,1608	
C531	2203-005015	C-CERAMIC,CHIP	150nF,+80-20%,16V,Y5V,TP,1608	
C532	2203-005015	C-CERAMIC,CHIP	150nF,+80-20%,16V,Y5V,TP,1608	
C533	2203-000189	C-CERAMIC,CHIP	100nF,+80-20%,25V,Y5V,TP,1608,	
C534	2402-001044	C-AL,SMD	100UF,20%,25V,GP,TP,8.3X8.3X6.3MM	
C535	2402-000170	C-AL,SMD	1uF,20%,50V,GP,TP,4.3x4.3x5.4,	
C536	2203-000701	C-CERAMIC,CHIP	0.002nF,0.25pF,50V,NP0,TP,2012	
C537	2203-000701	C-CERAMIC,CHIP	0.002nF,0.25pF,50V,NP0,TP,2012	
C538	2203-000903	C-CERAMIC,CHIP	0.0047nF,0.25pF,50V,NP0,TP,1608	
C539	2203-000903	C-CERAMIC,CHIP	0.0047nF,0.25pF,50V,NP0,TP,1608	

Loc. No.	Code No.	Description	Specification	Remarks
C54	2203-000626	C-CERAMIC,CHIP	0.022nF,5%,50V,NP0,TP,1608	
C540	2203-005015	C-CERAMIC,CHIP	150nF,+80-20%,16V,Y5V,TP,1608	
C541	2203-005015	C-CERAMIC,CHIP	150nF,+80-20%,16V,Y5V,TP,1608	
C542	2203-005015	C-CERAMIC,CHIP	150nF,+80-20%,16V,Y5V,TP,1608	
C543	2402-000170	C-AL,SMD	1uF,20%,50V,GP,TP,4.3x4.3x5.4,	
C544	2203-000440	C-CERAMIC,CHIP	1nF,10%,50V,X7R,TP,1608,-	
C545	2402-000173	C-AL,SMD	4.7uF,20%,35V,GP,TP,4.3x4.3x5.	
C546	2402-000173	C-AL,SMD	4.7uF,20%,35V,GP,TP,4.3x4.3x5.	
C547	2203-005015	C-CERAMIC,CHIP	150nF,+80-20%,16V,Y5V,TP,1608	
C548	2203-005015	C-CERAMIC,CHIP	150nF,+80-20%,16V,Y5V,TP,1608	
C549	2203-005015	C-CERAMIC,CHIP	150nF,+80-20%,16V,Y5V,TP,1608	
C55	2203-000626	C-CERAMIC,CHIP	0.022nF,5%,50V,NP0,TP,1608	
C550	2203-005015	C-CERAMIC,CHIP	150nF,+80-20%,16V,Y5V,TP,1608	
C551	2203-000189	C-CERAMIC,CHIP	100nF,+80-20%,25V,Y5V,TP,1608,	
C552	2203-000440	C-CERAMIC,CHIP	1nF,10%,50V,X7R,TP,1608,-	
C553	2203-000440	C-CERAMIC,CHIP	1nF,10%,50V,X7R,TP,1608,-	
C554	2203-000189	C-CERAMIC,CHIP	100nF,+80-20%,25V,Y5V,TP,1608,	
C556	2203-005015	C-CERAMIC,CHIP	150nF,+80-20%,16V,Y5V,TP,1608	
C557	2203-005015	C-CERAMIC,CHIP	150nF,+80-20%,16V,Y5V,TP,1608	
C558	2203-005015	C-CERAMIC,CHIP	150nF,+80-20%,16V,Y5V,TP,1608	
C559	2203-005189	C-CERAMIC,CHIP	680nF,+80-20%,16V,Y5V,TP,2012,	
C56	2402-000176	C-AL,SMD	10uF,20%,16V,GP,TP,4.3x4.3x5.4	
C560	2203-005189	C-CERAMIC,CHIP	680nF,+80-20%,16V,Y5V,TP,2012,	
C561	2203-000716	C-CERAMIC,CHIP	3.3nF,10%,50V,X7R,TP,2012,-	
C562	2203-000716	C-CERAMIC,CHIP	3.3nF,10%,50V,X7R,TP,2012,-	
C563	2402-000176	C-AL,SMD	10uF,20%,16V,GP,TP,4.3x4.3x5.4	
C564	2203-000189	C-CERAMIC,CHIP	100nF,+80-20%,25V,Y5V,TP,1608,	
C565	2203-001656	C-CERAMIC,CHIP	0.47nF,5%,50V,NP0,TP,1608	
C566	2402-000176	C-AL,SMD	10uF,20%,16V,GP,TP,4.3x4.3x5.4	
C567	2203-000140	C-CERAMIC,CHIP	1.5nF,10%,50V,X7R,TP,1608,-	
C568	2203-000972	C-CERAMIC,CHIP	47nF,10%,16V,X7R,TP,1608	
C569	2203-001607	C-CERAMIC,CHIP	0.22nF,5%,50V,NP0,TP,1608	
C57	2402-000176	C-AL,SMD	10uF,20%,16V,GP,TP,4.3x4.3x5.4	
C570	2203-000972	C-CERAMIC,CHIP	47nF,10%,16V,X7R,TP,1608	
C571	2402-001044	C-AL,SMD	100UF,20%,25V,GP,TP,8.3X8.3X6.3MM	
C572	2402-001006	C-AL,SMD	4.7uF,20%,25V,GP,TP,3.6x6.3x3.	
C573	2402-001006	C-AL,SMD	4.7uF,20%,25V,GP,TP,3.6x6.3x3.	
C574	2402-001044	C-AL,SMD	100UF,20%,25V,GP,TP,8.3X8.3X6.3MM	
C575	2402-001042	C-AL,SMD	100uF,20%,16V,GP,TP,6.6x6.6x5.4mm	
C576	2203-000204	C-CERAMIC,CHIP	100nF,10%,25V,X7R,TP,2012	
C577	2203-000784	C-CERAMIC,CHIP	0.33nF,5%,50V,NP0,TP,2012	
C578	2203-000140	C-CERAMIC,CHIP	1.5nF,10%,50V,X7R,TP,1608,-	
C579	2203-000140	C-CERAMIC,CHIP	1.5nF,10%,50V,X7R,TP,1608,-	
C58	2203-000189	C-CERAMIC,CHIP	100nF,+80-20%,25V,Y5V,TP,1608,	
C580	2402-001006	C-AL,SMD	4.7uF,20%,25V,GP,TP,3.6x6.3x3.	
C581	2402-001006	C-AL,SMD	4.7uF,20%,25V,GP,TP,3.6x6.3x3.	
C582	2203-000204	C-CERAMIC,CHIP	100nF,10%,25V,X7R,TP,2012	
C583	2203-000784	C-CERAMIC,CHIP	0.33nF,5%,50V,NP0,TP,2012	
C584	2402-001006	C-AL,SMD	4.7uF,20%,25V,GP,TP,3.6x6.3x3.	
C585	2402-001006	C-AL,SMD	4.7uF,20%,25V,GP,TP,3.6x6.3x3.	
C586	2203-000784	C-CERAMIC,CHIP	0.33nF,5%,50V,NP0,TP,2012	
C587	2203-000784	C-CERAMIC,CHIP	0.33nF,5%,50V,NP0,TP,2012	
C588	2402-001006	C-AL,SMD	4.7uF,20%,25V,GP,TP,3.6x6.3x3.	
C589	2402-001006	C-AL,SMD	4.7uF,20%,25V,GP,TP,3.6x6.3x3.	
C59	2203-000189	C-CERAMIC,CHIP	100nF,+80-20%,25V,Y5V,TP,1608,	
C590	2203-000784	C-CERAMIC,CHIP	0.33nF,5%,50V,NP0,TP,2012	
C591	2203-000784	C-CERAMIC,CHIP	0.33nF,5%,50V,NP0,TP,2012	
C6	2402-000176	C-AL,SMD	10uF,20%,16V,GP,TP,4.3x4.3x5.4	
C60	2203-000189	C-CERAMIC,CHIP	100nF,+80-20%,25V,Y5V,TP,1608,	
C601	2203-000440	C-CERAMIC,CHIP	1nF,10%,50V,X7R,TP,1608,-	
C602	2203-000440	C-CERAMIC,CHIP	1nF,10%,50V,X7R,TP,1608,-	
C603	2203-000440	C-CERAMIC,CHIP	1nF,10%,50V,X7R,TP,1608,-	
C604	2203-000440	C-CERAMIC,CHIP	1nF,10%,50V,X7R,TP,1608,-	
C605	2203-000440	C-CERAMIC,CHIP	1nF,10%,50V,X7R,TP,1608,-	
C606	2203-000440	C-CERAMIC,CHIP	1nF,10%,50V,X7R,TP,1608,-	
C607	2203-000440	C-CERAMIC,CHIP	1nF,10%,50V,X7R,TP,1608,-	
C608	2203-000440	C-CERAMIC,CHIP	1nF,10%,50V,X7R,TP,1608,-	
C609	2203-000440	C-CERAMIC,CHIP	1nF,10%,50V,X7R,TP,1608,-	
C61	2203-000189	C-CERAMIC,CHIP	100nF,+80-20%,25V,Y5V,TP,1608,	
C610	2203-000440	C-CERAMIC,CHIP	1nF,10%,50V,X7R,TP,1608,-	

Loc. No.	Code No.	Description	Specification	Remarks
C611	2203-000440	C-CERAMIC,CHIP	1nF,10%,50V,X7R,TP,1608,-	
C612	2203-000189	C-CERAMIC,CHIP	100nF,+80-20%,25V,Y5V,TP,1608,	
C613	2203-000189	C-CERAMIC,CHIP	100nF,+80-20%,25V,Y5V,TP,1608,	
C614	2203-000189	C-CERAMIC,CHIP	100nF,+80-20%,25V,Y5V,TP,1608,	
C615	2203-000189	C-CERAMIC,CHIP	100nF,+80-20%,25V,Y5V,TP,1608,	
C616	2203-000189	C-CERAMIC,CHIP	100nF,+80-20%,25V,Y5V,TP,1608,	
C617	2203-000189	C-CERAMIC,CHIP	100nF,+80-20%,25V,Y5V,TP,1608,	
C618	2203-000189	C-CERAMIC,CHIP	100nF,+80-20%,25V,Y5V,TP,1608,	
C619	2203-000189	C-CERAMIC,CHIP	100nF,+80-20%,25V,Y5V,TP,1608,	
C62	2203-000189	C-CERAMIC,CHIP	100nF,+80-20%,25V,Y5V,TP,1608,	
C620	2203-000189	C-CERAMIC,CHIP	100nF,+80-20%,25V,Y5V,TP,1608,	
C621	2203-000189	C-CERAMIC,CHIP	100nF,+80-20%,25V,Y5V,TP,1608,	
C622	2203-000189	C-CERAMIC,CHIP	100nF,+80-20%,25V,Y5V,TP,1608,	
C623	2402-000209	C-AL,SMD	22uF,20%,16V,WT,TP,5.3x5.3mm,1	
C624	2402-000209	C-AL,SMD	22uF,20%,16V,WT,TP,5.3x5.3mm,1	
C625	2203-000189	C-CERAMIC,CHIP	100nF,+80-20%,25V,Y5V,TP,1608,	
C626	2203-000189	C-CERAMIC,CHIP	100nF,+80-20%,25V,Y5V,TP,1608,	
C627	2203-000189	C-CERAMIC,CHIP	100nF,+80-20%,25V,Y5V,TP,1608,	
C628	2203-000189	C-CERAMIC,CHIP	100nF,+80-20%,25V,Y5V,TP,1608,	
C629	2203-000189	C-CERAMIC,CHIP	100nF,+80-20%,25V,Y5V,TP,1608,	
C63	2203-000189	C-CERAMIC,CHIP	100nF,+80-20%,25V,Y5V,TP,1608,	
C630	2203-000189	C-CERAMIC,CHIP	100nF,+80-20%,25V,Y5V,TP,1608,	
C631	2203-000189	C-CERAMIC,CHIP	100nF,+80-20%,25V,Y5V,TP,1608,	
C632	2203-000189	C-CERAMIC,CHIP	100nF,+80-20%,25V,Y5V,TP,1608,	
C633	2203-000189	C-CERAMIC,CHIP	100nF,+80-20%,25V,Y5V,TP,1608,	
C634	2203-000189	C-CERAMIC,CHIP	100nF,+80-20%,25V,Y5V,TP,1608,	
C635	2203-000189	C-CERAMIC,CHIP	100nF,+80-20%,25V,Y5V,TP,1608,	
C636	2203-000189	C-CERAMIC,CHIP	100nF,+80-20%,25V,Y5V,TP,1608,	
C637	2402-000209	C-AL,SMD	22uF,20%,16V,WT,TP,5.3x5.3mm,1	
C638	2203-000189	C-CERAMIC,CHIP	100nF,+80-20%,25V,Y5V,TP,1608,	
C639	2203-000189	C-CERAMIC,CHIP	100nF,+80-20%,25V,Y5V,TP,1608,	
C64	2402-001155	C-AL,SMD	47UF,20%,16V,WT,TP,6.3X5.2MM	
C640	2203-000189	C-CERAMIC,CHIP	100nF,+80-20%,25V,Y5V,TP,1608,	
C641	2203-000189	C-CERAMIC,CHIP	100nF,+80-20%,25V,Y5V,TP,1608,	
C642	2203-000189	C-CERAMIC,CHIP	100nF,+80-20%,25V,Y5V,TP,1608,	
C643	2203-000189	C-CERAMIC,CHIP	100nF,+80-20%,25V,Y5V,TP,1608,	
C644	2203-000189	C-CERAMIC,CHIP	100nF,+80-20%,25V,Y5V,TP,1608,	
C645	2203-000189	C-CERAMIC,CHIP	100nF,+80-20%,25V,Y5V,TP,1608,	
C646	2203-000189	C-CERAMIC,CHIP	100nF,+80-20%,25V,Y5V,TP,1608,	
C647	2203-000189	C-CERAMIC,CHIP	100nF,+80-20%,25V,Y5V,TP,1608,	
C648	2203-000189	C-CERAMIC,CHIP	100nF,+80-20%,25V,Y5V,TP,1608,	
C649	2203-000189	C-CERAMIC,CHIP	100nF,+80-20%,25V,Y5V,TP,1608,	
C65	2402-001155	C-AL,SMD	47UF,20%,16V,WT,TP,6.3X5.2MM	
C650	2203-000440	C-CERAMIC,CHIP	1nF,10%,50V,X7R,TP,1608,-	
C651	2203-000440	C-CERAMIC,CHIP	1nF,10%,50V,X7R,TP,1608,-	
C652	2203-000440	C-CERAMIC,CHIP	1nF,10%,50V,X7R,TP,1608,-	
C653	2203-000440	C-CERAMIC,CHIP	1nF,10%,50V,X7R,TP,1608,-	
C654	2203-000189	C-CERAMIC,CHIP	100nF,+80-20%,25V,Y5V,TP,1608,	
C655	2203-000189	C-CERAMIC,CHIP	100nF,+80-20%,25V,Y5V,TP,1608,	
C656	2203-000189	C-CERAMIC,CHIP	100nF,+80-20%,25V,Y5V,TP,1608,	
C657	2203-000189	C-CERAMIC,CHIP	100nF,+80-20%,25V,Y5V,TP,1608,	
C658	2203-000189	C-CERAMIC,CHIP	100nF,+80-20%,25V,Y5V,TP,1608,	
C659	2203-000189	C-CERAMIC,CHIP	100nF,+80-20%,25V,Y5V,TP,1608,	
C66	2203-000236	C-CERAMIC,CHIP	0.1nF,5%,50V,NP0,TP,1608	
C660	2203-000189	C-CERAMIC,CHIP	100nF,+80-20%,25V,Y5V,TP,1608,	
C661	2203-000189	C-CERAMIC,CHIP	100nF,+80-20%,25V,Y5V,TP,1608,	
C662	2203-000189	C-CERAMIC,CHIP	100nF,+80-20%,25V,Y5V,TP,1608,	
C663	2203-000189	C-CERAMIC,CHIP	100nF,+80-20%,25V,Y5V,TP,1608,	
C664	2203-000189	C-CERAMIC,CHIP	100nF,+80-20%,25V,Y5V,TP,1608,	
C665	2203-000189	C-CERAMIC,CHIP	100nF,+80-20%,25V,Y5V,TP,1608,	
C666	2402-000209	C-AL,SMD	22uF,20%,16V,WT,TP,5.3x5.3mm,1	
C667	2409-001035	C-ORGANIC	10uF,20%,10V,LZ,TP,5.4x4.3x4.3mm,1	
C668	2203-000189	C-CERAMIC,CHIP	100nF,+80-20%,25V,Y5V,TP,1608,	
C669	2203-000189	C-CERAMIC,CHIP	100nF,+80-20%,25V,Y5V,TP,1608,	
C67	2203-000236	C-CERAMIC,CHIP	0.1nF,5%,50V,NP0,TP,1608	
C670	2203-000189	C-CERAMIC,CHIP	100nF,+80-20%,25V,Y5V,TP,1608,	
C671	2203-000384	C-CERAMIC,CHIP	0.015nF,5%,50V,NP0,TP,1608	
C672	2203-005065	C-CERAMIC,CHIP	1000nF,+80-20%,10V,Y5V,TP,1608	
C673	2203-005065	C-CERAMIC,CHIP	1000nF,+80-20%,10V,Y5V,TP,1608	
C674	2203-005065	C-CERAMIC,CHIP	1000nF,+80-20%,10V,Y5V,TP,1608	

Loc. No.	Code No.	Description	Specification	Remarks
C675	2203-005065	C-CERAMIC,CHIP	1000nF,+80-20%,10V,Y5V,TP,1608	
C676	2203-005065	C-CERAMIC,CHIP	1000nF,+80-20%,10V,Y5V,TP,1608	
C677	2203-005065	C-CERAMIC,CHIP	1000nF,+80-20%,10V,Y5V,TP,1608	
C678	2203-000189	C-CERAMIC,CHIP	100nF,+80-20%,25V,Y5V,TP,1608,	
C679	2203-000280	C-CERAMIC,CHIP	0.01nF,0.5pF,50V,NP0,TP,1608	
C68	2203-000189	C-CERAMIC,CHIP	100nF,+80-20%,25V,Y5V,TP,1608,	
C69	2402-001044	C-AL,SMD	100UF,20%,25V,GP,TP,8.3X8.3X6.3MM	
C7	2203-000189	C-CERAMIC,CHIP	100nF,+80-20%,25V,Y5V,TP,1608,	
C70	2402-000176	C-AL,SMD	10uF,20%,16V,GP,TP,4.3x4.3x5.4	
C701	2402-000209	C-AL,SMD	22uF,20%,16V,WT,TP,5.3x5.3mm,1	
C702	2203-000189	C-CERAMIC,CHIP	100nF,+80-20%,25V,Y5V,TP,1608,	
C703	2203-000189	C-CERAMIC,CHIP	100nF,+80-20%,25V,Y5V,TP,1608,	
C704	2203-000189	C-CERAMIC,CHIP	100nF,+80-20%,25V,Y5V,TP,1608,	
C705	2203-000189	C-CERAMIC,CHIP	100nF,+80-20%,25V,Y5V,TP,1608,	
C706	2203-000189	C-CERAMIC,CHIP	100nF,+80-20%,25V,Y5V,TP,1608,	
C707	2402-000209	C-AL,SMD	22uF,20%,16V,WT,TP,5.3x5.3mm,1	
C708	2203-000189	C-CERAMIC,CHIP	100nF,+80-20%,25V,Y5V,TP,1608,	
C709	2203-000189	C-CERAMIC,CHIP	100nF,+80-20%,25V,Y5V,TP,1608,	
C710	2203-000189	C-CERAMIC,CHIP	100nF,+80-20%,25V,Y5V,TP,1608,	
C711	2203-000189	C-CERAMIC,CHIP	100nF,+80-20%,25V,Y5V,TP,1608,	
C712	2203-000189	C-CERAMIC,CHIP	100nF,+80-20%,25V,Y5V,TP,1608,	
C713	2203-000189	C-CERAMIC,CHIP	100nF,+80-20%,25V,Y5V,TP,1608,	
C714	2203-000189	C-CERAMIC,CHIP	100nF,+80-20%,25V,Y5V,TP,1608,	
C715	2203-000189	C-CERAMIC,CHIP	100nF,+80-20%,25V,Y5V,TP,1608,	
C716	2203-000384	C-CERAMIC,CHIP	0.015nF,5%,50V,NP0,TP,1608	
C717	2203-000384	C-CERAMIC,CHIP	0.015nF,5%,50V,NP0,TP,1608	
C718	2203-000384	C-CERAMIC,CHIP	0.015nF,5%,50V,NP0,TP,1608	
C719	2203-000189	C-CERAMIC,CHIP	100nF,+80-20%,25V,Y5V,TP,1608,	
C720	2203-000626	C-CERAMIC,CHIP	0.022nF,5%,50V,NP0,TP,1608	
C721	2203-001222	C-CERAMIC,CHIP	820pF,10%,50V,X7R,TP,1608,-	
C722	2203-001222	C-CERAMIC,CHIP	820pF,10%,50V,X7R,TP,1608,-	
C723	2402-000209	C-AL,SMD	22uF,20%,16V,WT,TP,5.3x5.3mm,1	
C724	2203-000189	C-CERAMIC,CHIP	100nF,+80-20%,25V,Y5V,TP,1608,	
C725	2203-000189	C-CERAMIC,CHIP	100nF,+80-20%,25V,Y5V,TP,1608,	
C726	2203-000189	C-CERAMIC,CHIP	100nF,+80-20%,25V,Y5V,TP,1608,	
C727	2203-000189	C-CERAMIC,CHIP	100nF,+80-20%,25V,Y5V,TP,1608,	
C728	2203-000189	C-CERAMIC,CHIP	100nF,+80-20%,25V,Y5V,TP,1608,	
C729	2203-000189	C-CERAMIC,CHIP	100nF,+80-20%,25V,Y5V,TP,1608,	
C730	2203-000189	C-CERAMIC,CHIP	100nF,+80-20%,25V,Y5V,TP,1608,	
C731	2203-000189	C-CERAMIC,CHIP	100nF,+80-20%,25V,Y5V,TP,1608,	
C732	2203-000189	C-CERAMIC,CHIP	100nF,+80-20%,25V,Y5V,TP,1608,	
C733	2203-000189	C-CERAMIC,CHIP	100nF,+80-20%,25V,Y5V,TP,1608,	
C734	2203-000189	C-CERAMIC,CHIP	100nF,+80-20%,25V,Y5V,TP,1608,	
C735	2203-000189	C-CERAMIC,CHIP	100nF,+80-20%,25V,Y5V,TP,1608,	
C736	2203-000384	C-CERAMIC,CHIP	0.015nF,5%,50V,NP0,TP,1608	
C8	2203-000189	C-CERAMIC,CHIP	100nF,+80-20%,25V,Y5V,TP,1608,	
C801	2203-000440	C-CERAMIC,CHIP	1nF,10%,50V,X7R,TP,1608,-	
C802	2203-000440	C-CERAMIC,CHIP	1nF,10%,50V,X7R,TP,1608,-	
C803	2203-000440	C-CERAMIC,CHIP	1nF,10%,50V,X7R,TP,1608,-	
C804	2203-000440	C-CERAMIC,CHIP	1nF,10%,50V,X7R,TP,1608,-	
C805	2203-000440	C-CERAMIC,CHIP	1nF,10%,50V,X7R,TP,1608,-	
C806	2203-000440	C-CERAMIC,CHIP	1nF,10%,50V,X7R,TP,1608,-	
C807	2203-000440	C-CERAMIC,CHIP	1nF,10%,50V,X7R,TP,1608,-	
C808	2203-000440	C-CERAMIC,CHIP	1nF,10%,50V,X7R,TP,1608,-	
C809	2203-000440	C-CERAMIC,CHIP	1nF,10%,50V,X7R,TP,1608,-	
C810	2203-000440	C-CERAMIC,CHIP	1nF,10%,50V,X7R,TP,1608,-	
C811	2203-000440	C-CERAMIC,CHIP	1nF,10%,50V,X7R,TP,1608,-	
C812	2203-000189	C-CERAMIC,CHIP	100nF,+80-20%,25V,Y5V,TP,1608,	
C813	2203-000189	C-CERAMIC,CHIP	100nF,+80-20%,25V,Y5V,TP,1608,	
C814	2203-000189	C-CERAMIC,CHIP	100nF,+80-20%,25V,Y5V,TP,1608,	
C815	2203-000189	C-CERAMIC,CHIP	100nF,+80-20%,25V,Y5V,TP,1608,	
C816	2203-000189	C-CERAMIC,CHIP	100nF,+80-20%,25V,Y5V,TP,1608,	
C817	2203-000189	C-CERAMIC,CHIP	100nF,+80-20%,25V,Y5V,TP,1608,	
C818	2203-000189	C-CERAMIC,CHIP	100nF,+80-20%,25V,Y5V,TP,1608,	
C819	2203-000189	C-CERAMIC,CHIP	100nF,+80-20%,25V,Y5V,TP,1608,	
C820	2203-000189	C-CERAMIC,CHIP	100nF,+80-20%,25V,Y5V,TP,1608,	
C821	2203-000189	C-CERAMIC,CHIP	100nF,+80-20%,25V,Y5V,TP,1608,	
C822	2203-000189	C-CERAMIC,CHIP	100nF,+80-20%,25V,Y5V,TP,1608,	
C823	2402-000209	C-AL,SMD	22uF,20%,16V,WT,TP,5.3x5.3mm,1	
C824	2203-000440	C-CERAMIC,CHIP	1nF,10%,50V,X7R,TP,1608,-	

Loc. No.	Code No.	Description	Specification	Remarks
C825	2203-000440	C-CERAMIC,CHIP	1nF,10%,50V,X7R,TP,1608,-	
C826	2203-000440	C-CERAMIC,CHIP	1nF,10%,50V,X7R,TP,1608,-	
C827	2203-000440	C-CERAMIC,CHIP	1nF,10%,50V,X7R,TP,1608,-	
C828	2203-000189	C-CERAMIC,CHIP	100nF,+80-20%,25V,Y5V,TP,1608,	
C829	2203-000189	C-CERAMIC,CHIP	100nF,+80-20%,25V,Y5V,TP,1608,	
C830	2203-000189	C-CERAMIC,CHIP	100nF,+80-20%,25V,Y5V,TP,1608,	
C831	2203-000189	C-CERAMIC,CHIP	100nF,+80-20%,25V,Y5V,TP,1608,	
C832	2203-000189	C-CERAMIC,CHIP	100nF,+80-20%,25V,Y5V,TP,1608,	
C833	2203-000189	C-CERAMIC,CHIP	100nF,+80-20%,25V,Y5V,TP,1608,	
C834	2203-000189	C-CERAMIC,CHIP	100nF,+80-20%,25V,Y5V,TP,1608,	
C835	2203-000189	C-CERAMIC,CHIP	100nF,+80-20%,25V,Y5V,TP,1608,	
C836	2203-000189	C-CERAMIC,CHIP	100nF,+80-20%,25V,Y5V,TP,1608,	
C837	2203-000189	C-CERAMIC,CHIP	100nF,+80-20%,25V,Y5V,TP,1608,	
C838	2203-000189	C-CERAMIC,CHIP	100nF,+80-20%,25V,Y5V,TP,1608,	
C839	2203-000189	C-CERAMIC,CHIP	100nF,+80-20%,25V,Y5V,TP,1608,	
C840	2402-000209	C-AL,SMD	22uF,20%,16V,WT,TP,5.3x5.3mm,1	
C841	2409-001035	C-ORGANIC	10uF,20%,10V,LZ,TP,5.4x4.3x4.3mm,1	
C842	2203-000189	C-CERAMIC,CHIP	100nF,+80-20%,25V,Y5V,TP,1608,	
C843	2203-000189	C-CERAMIC,CHIP	100nF,+80-20%,25V,Y5V,TP,1608,	
C844	2203-000189	C-CERAMIC,CHIP	100nF,+80-20%,25V,Y5V,TP,1608,	
C845	2402-000209	C-AL,SMD	22uF,20%,16V,WT,TP,5.3x5.3mm,1	
C846	2203-000384	C-CERAMIC,CHIP	0.015nF,5%,50V,NPO,TP,1608	
C847	2402-000209	C-AL,SMD	22uF,20%,16V,WT,TP,5.3x5.3mm,1	
C848	2203-000189	C-CERAMIC,CHIP	100nF,+80-20%,25V,Y5V,TP,1608,	
C849	2203-000189	C-CERAMIC,CHIP	100nF,+80-20%,25V,Y5V,TP,1608,	
C850	2203-000189	C-CERAMIC,CHIP	100nF,+80-20%,25V,Y5V,TP,1608,	
C851	2203-000189	C-CERAMIC,CHIP	100nF,+80-20%,25V,Y5V,TP,1608,	
C852	2203-000189	C-CERAMIC,CHIP	100nF,+80-20%,25V,Y5V,TP,1608,	
C853	2203-000189	C-CERAMIC,CHIP	100nF,+80-20%,25V,Y5V,TP,1608,	
C854	2203-000189	C-CERAMIC,CHIP	100nF,+80-20%,25V,Y5V,TP,1608,	
C855	2203-000189	C-CERAMIC,CHIP	100nF,+80-20%,25V,Y5V,TP,1608,	
C856	2203-000189	C-CERAMIC,CHIP	100nF,+80-20%,25V,Y5V,TP,1608,	
C857	2203-000189	C-CERAMIC,CHIP	100nF,+80-20%,25V,Y5V,TP,1608,	
C858	2203-000189	C-CERAMIC,CHIP	100nF,+80-20%,25V,Y5V,TP,1608,	
C859	2203-000189	C-CERAMIC,CHIP	100nF,+80-20%,25V,Y5V,TP,1608,	
C860	2402-000209	C-AL,SMD	22uF,20%,16V,WT,TP,5.3x5.3mm,1	
C861	2203-000189	C-CERAMIC,CHIP	100nF,+80-20%,25V,Y5V,TP,1608,	
C862	2203-000189	C-CERAMIC,CHIP	100nF,+80-20%,25V,Y5V,TP,1608,	
C863	2203-000189	C-CERAMIC,CHIP	100nF,+80-20%,25V,Y5V,TP,1608,	
C864	2203-000189	C-CERAMIC,CHIP	100nF,+80-20%,25V,Y5V,TP,1608,	
C865	2203-000189	C-CERAMIC,CHIP	100nF,+80-20%,25V,Y5V,TP,1608,	
C866	2203-000189	C-CERAMIC,CHIP	100nF,+80-20%,25V,Y5V,TP,1608,	
C867	2203-000189	C-CERAMIC,CHIP	100nF,+80-20%,25V,Y5V,TP,1608,	
C868	2203-000189	C-CERAMIC,CHIP	100nF,+80-20%,25V,Y5V,TP,1608,	
C869	2203-000189	C-CERAMIC,CHIP	100nF,+80-20%,25V,Y5V,TP,1608,	
C870	2203-000189	C-CERAMIC,CHIP	100nF,+80-20%,25V,Y5V,TP,1608,	
C871	2203-000189	C-CERAMIC,CHIP	100nF,+80-20%,25V,Y5V,TP,1608,	
C872	2203-000189	C-CERAMIC,CHIP	100nF,+80-20%,25V,Y5V,TP,1608,	
C873	2203-000384	C-CERAMIC,CHIP	0.015nF,5%,50V,NPO,TP,1608	
C888	2203-000626	C-CERAMIC,CHIP	0.022nF,5%,50V,NPO,TP,1608	
C9	2203-000189	C-CERAMIC,CHIP	100nF,+80-20%,25V,Y5V,TP,1608,	
C901	2203-000189	C-CERAMIC,CHIP	100nF,+80-20%,25V,Y5V,TP,1608,	
C915	2203-005137	C-CERAMIC,CHIP	10uF,+80-20%,50V,JE,TP,5650,-	
C916	2203-005137	C-CERAMIC,CHIP	10uF,+80-20%,50V,JE,TP,5650,-	
C917	2203-005137	C-CERAMIC,CHIP	10uF,+80-20%,50V,JE,TP,5650,-	
C918	2203-005137	C-CERAMIC,CHIP	10uF,+80-20%,50V,JE,TP,5650,-	
C919	2203-000575	C-CERAMIC,CHIP	220NF,10%,25V,X7R,TP,2012	
C920	2203-000925	C-CERAMIC,CHIP	470NF,+80-20%,50V,Y5V,TP,2012	
C921	2203-001048	C-CERAMIC,CHIP	0.56nF,10%,50V,NPO,TP,2012	
C922	2203-001652	C-CERAMIC,CHIP	470nF,+80-20%,16V,Y5V,TP,1608	
C923	2409-001065	C-ORGANIC	82UF,20%,16V,WT,TP,8X6.9MM,-	
C924	2409-001065	C-ORGANIC	82UF,20%,16V,WT,TP,8X6.9MM,-	
C925	2409-001065	C-ORGANIC	82UF,20%,16V,WT,TP,8X6.9MM,-	
C926	2409-001065	C-ORGANIC	82UF,20%,16V,WT,TP,8X6.9MM,-	
C927	2409-001065	C-ORGANIC	82UF,20%,16V,WT,TP,8X6.9MM,-	
C928	2203-005137	C-CERAMIC,CHIP	10uF,+80-20%,50V,JE,TP,5650,-	
C929	2203-000206	C-CERAMIC,CHIP	100nF,10%,50V,X7R,TP,2012	
C930	2203-001724	C-CERAMIC,CHIP	4700NF,+80-20%,16V,Y5V,TP,3216	
C931	2203-000189	C-CERAMIC,CHIP	100nF,+80-20%,25V,Y5V,TP,1608,	
C932	2203-000491	C-CERAMIC,CHIP	2.2nF,10%,50V,X7R,TP,1608,-	

Loc. No.	Code No.	Description	Specification	Remarks
C935	2402-001044	C-AL,SMD	100UF,20%,25V,GP,TP,8.3X8.3X6.3MM	
C936	2402-001044	C-AL,SMD	100UF,20%,25V,GP,TP,8.3X8.3X6.3MM	
C937	2409-001035	C-ORGANIC	10uF,20%,10V,LZ,TP,5.4x4.3x4.3mm,1	
C938	2203-000257	C-CERAMIC,CHIP	10nF,10%,50V,X7R,TP,1608	
C939	2203-000189	C-CERAMIC,CHIP	100nF,+80-20%,25V,Y5V,TP,1608,	
C940	2203-005137	C-CERAMIC,CHIP	10uF,+80-20%,50V,JE,TP,5650,-	
C941	2203-005137	C-CERAMIC,CHIP	10uF,+80-20%,50V,JE,TP,5650,-	
C942	2203-000257	C-CERAMIC,CHIP	10nF,10%,50V,X7R,TP,1608	
C943	2203-000189	C-CERAMIC,CHIP	100nF,+80-20%,25V,Y5V,TP,1608,	
C944	2203-005137	C-CERAMIC,CHIP	10uF,+80-20%,50V,JE,TP,5650,-	
C945	2203-005137	C-CERAMIC,CHIP	10uF,+80-20%,50V,JE,TP,5650,-	
C946	2203-000189	C-CERAMIC,CHIP	100nF,+80-20%,25V,Y5V,TP,1608,	
C947	2203-000257	C-CERAMIC,CHIP	10nF,10%,50V,X7R,TP,1608	
C948	2203-000189	C-CERAMIC,CHIP	100nF,+80-20%,25V,Y5V,TP,1608,	
C949	2402-001044	C-AL,SMD	100UF,20%,25V,GP,TP,8.3X8.3X6.3MM	
C950	2203-000257	C-CERAMIC,CHIP	10nF,10%,50V,X7R,TP,1608	
C951	2203-000189	C-CERAMIC,CHIP	100nF,+80-20%,25V,Y5V,TP,1608,	
C952	2409-001065	C-ORGANIC	82UF,20%,16V,WT,TP,8X6.9MM,-	
C953	2402-001044	C-AL,SMD	100UF,20%,25V,GP,TP,8.3X8.3X6.3MM	
C954	2402-001044	C-AL,SMD	100UF,20%,25V,GP,TP,8.3X8.3X6.3MM	
C955	2402-001044	C-AL,SMD	100UF,20%,25V,GP,TP,8.3X8.3X6.3MM	
C956	2203-000257	C-CERAMIC,CHIP	10nF,10%,50V,X7R,TP,1608	
C957	2203-000189	C-CERAMIC,CHIP	100nF,+80-20%,25V,Y5V,TP,1608,	
C958	2203-005137	C-CERAMIC,CHIP	10uF,+80-20%,50V,JE,TP,5650,-	
C959	2203-005137	C-CERAMIC,CHIP	10uF,+80-20%,50V,JE,TP,5650,-	
C960	2203-000257	C-CERAMIC,CHIP	10nF,10%,50V,X7R,TP,1608	
C961	2203-000189	C-CERAMIC,CHIP	100nF,+80-20%,25V,Y5V,TP,1608,	
C962	2402-001044	C-AL,SMD	100UF,20%,25V,GP,TP,8.3X8.3X6.3MM	
C963	2203-000257	C-CERAMIC,CHIP	10nF,10%,50V,X7R,TP,1608	
C964	2203-000189	C-CERAMIC,CHIP	100nF,+80-20%,25V,Y5V,TP,1608,	
C965	2409-001065	C-ORGANIC	82UF,20%,16V,WT,TP,8X6.9MM,-	
C966	2402-001044	C-AL,SMD	100UF,20%,25V,GP,TP,8.3X8.3X6.3MM	
C967	2402-001044	C-AL,SMD	100UF,20%,25V,GP,TP,8.3X8.3X6.3MM	
C968	2402-001044	C-AL,SMD	100UF,20%,25V,GP,TP,8.3X8.3X6.3MM	
C969	2203-000257	C-CERAMIC,CHIP	10nF,10%,50V,X7R,TP,1608	
C970	2203-000189	C-CERAMIC,CHIP	100nF,+80-20%,25V,Y5V,TP,1608,	
C971	2203-005137	C-CERAMIC,CHIP	10uF,+80-20%,50V,JE,TP,5650,-	
C972	2203-005137	C-CERAMIC,CHIP	10uF,+80-20%,50V,JE,TP,5650,-	
C973	2409-001065	C-ORGANIC	82UF,20%,16V,WT,TP,8X6.9MM,-	
C974	2203-000189	C-CERAMIC,CHIP	100nF,+80-20%,25V,Y5V,TP,1608,	
C975	2402-001155	C-AL,SMD	47UF,20%,16V,WT,TP,6.3X5.2MM	
C976	2402-001044	C-AL,SMD	100UF,20%,25V,GP,TP,8.3X8.3X6.3MM	
C977	2203-005005	C-CERAMIC,CHIP	100nF,10%,16V,X7R,TP,1608	
C978	2402-001155	C-AL,SMD	47UF,20%,16V,WT,TP,6.3X5.2MM	
C979	2402-001044	C-AL,SMD	100UF,20%,25V,GP,TP,8.3X8.3X6.3MM	
C980	2203-005005	C-CERAMIC,CHIP	100nF,10%,16V,X7R,TP,1608	
C981	2409-001035	C-ORGANIC	10uF,20%,10V,LZ,TP,5.4x4.3x4.3mm,1	
C982	2402-000176	C-AL,SMD	10uF,20%,16V,GP,TP,4.3x4.3x5.4	
C983	2402-000176	C-AL,SMD	10uF,20%,16V,GP,TP,4.3x4.3x5.4	
C984	2203-005005	C-CERAMIC,CHIP	100nF,10%,16V,X7R,TP,1608	
C985	2203-005005	C-CERAMIC,CHIP	100nF,10%,16V,X7R,TP,1608	
C986	2203-000257	C-CERAMIC,CHIP	10nF,10%,50V,X7R,TP,1608	
C987	2203-000189	C-CERAMIC,CHIP	100nF,+80-20%,25V,Y5V,TP,1608,	
C988	2203-005137	C-CERAMIC,CHIP	10uF,+80-20%,50V,JE,TP,5650,-	
C989	2203-005137	C-CERAMIC,CHIP	10uF,+80-20%,50V,JE,TP,5650,-	
C990	2203-005065	C-CERAMIC,CHIP	1000nF,+80-20%,10V,Y5V,TP,1608	
C991	2409-001065	C-ORGANIC	82UF,20%,16V,WT,TP,8X6.9MM,-	
C992	2409-001035	C-ORGANIC	10uF,20%,10V,LZ,TP,5.4x4.3x4.3mm,1	
C993	2203-000189	C-CERAMIC,CHIP	100nF,+80-20%,25V,Y5V,TP,1608,	
C994	2203-000257	C-CERAMIC,CHIP	10nF,10%,50V,X7R,TP,1608	
C995	2203-000189	C-CERAMIC,CHIP	100nF,+80-20%,25V,Y5V,TP,1608,	
C996	2203-005137	C-CERAMIC,CHIP	10uF,+80-20%,50V,JE,TP,5650,-	
C997	2203-005137	C-CERAMIC,CHIP	10uF,+80-20%,50V,JE,TP,5650,-	
C998	2203-005065	C-CERAMIC,CHIP	1000nF,+80-20%,10V,Y5V,TP,1608	
CA201	2503-001018	C-NETWORK	15PFX4,10%,50V,-	
CA202	2503-001018	C-NETWORK	15PFX4,10%,50V,-	
CA203	2503-001018	C-NETWORK	15PFX4,10%,50V,-	
CA204	2503-001018	C-NETWORK	15PFX4,10%,50V,-	
CA205	2503-001018	C-NETWORK	15PFX4,10%,50V,-	
CA206	2503-001018	C-NETWORK	15PFX4,10%,50V,-	

Loc. No.	Code No.	Description	Specification	Remarks
CA207	2503-001018	C-NETWORK	15PFX4,10%,50V,-	
CA208	2503-001018	C-NETWORK	15PFX4,10%,50V,-	
CA209	2503-001018	C-NETWORK	15PFX4,10%,50V,-	
CA210	2503-001018	C-NETWORK	15PFX4,10%,50V,-	
CA211	2503-001018	C-NETWORK	15PFX4,10%,50V,-	
CA212	2503-001018	C-NETWORK	15PFX4,10%,50V,-	
CA401	2503-001018	C-NETWORK	15PFX4,10%,50V,-	
CA402	2503-001018	C-NETWORK	15PFX4,10%,50V,-	
CA403	2503-001018	C-NETWORK	15PFX4,10%,50V,-	
CA404	2503-001018	C-NETWORK	15PFX4,10%,50V,-	
CA801	2503-001018	C-NETWORK	15PFX4,10%,50V,-	
CA802	2503-001018	C-NETWORK	15PFX4,10%,50V,-	
CA803	2503-001018	C-NETWORK	15PFX4,10%,50V,-	
CA804	2503-001018	C-NETWORK	15PFX4,10%,50V,-	
CA805	2503-001018	C-NETWORK	15PFX4,10%,50V,-	
CA806	2503-001018	C-NETWORK	15PFX4,10%,50V,-	
CA807	2503-001018	C-NETWORK	15PFX4,10%,50V,-	
CA808	2503-001018	C-NETWORK	15PFX4,10%,50V,-	
CA809	2503-001018	C-NETWORK	15PFX4,10%,50V,-	
CA810	2503-001018	C-NETWORK	15PFX4,10%,50V,-	
CA811	2503-001018	C-NETWORK	15PFX4,10%,50V,-	
CA812	2503-001018	C-NETWORK	15PFX4,10%,50V,-	
CL950	BN27-00002A	COIL-CHOKE(SMD)	47uH,47uH,20%,12*12*8mm,22.5Ts,SMD,-,-,0.75ohm,-,-,-,TP	
CL951	BN27-00002A	COIL-CHOKE(SMD)	47uH,47uH,20%,12*12*8mm,22.5Ts,SMD,-,-,0.75ohm,-,-,-,TP	
CL952	BN27-00002A	COIL-CHOKE(SMD)	47uH,47uH,20%,12*12*8mm,22.5Ts,SMD,-,-,0.75ohm,-,-,-,TP	
CL954	BN27-00002A	COIL-CHOKE(SMD)	47uH,47uH,20%,12*12*8mm,22.5Ts,SMD,-,-,0.75ohm,-,-,-,TP	
CL955	BN27-00002A	COIL-CHOKE(SMD)	47uH,47uH,20%,12*12*8mm,22.5Ts,SMD,-,-,0.75ohm,-,-,-,TP	
CL956	BN27-00002A	COIL-CHOKE(SMD)	47uH,47uH,20%,12*12*8mm,22.5Ts,SMD,-,-,0.75ohm,-,-,-,TP	
CN1	3711-004070	CONNECTOR-HEADER	BOX,30P,1R,1.25mm,SMD-A,SN	SNA
CN101	3711-002049	CONNECTOR-HEADER	BOX,6P,1R,1.25mm,SMD-A,SN	SNA
CN170	3711-002049	CONNECTOR-HEADER	BOX,6P,1R,1.25mm,SMD-A,SN	SNA
CN201	3711-004070	CONNECTOR-HEADER	BOX,30P,1R,1.25mm,SMD-A,SN	SNA
CN3	3711-003161	CONNECTOR-HEADER	BOX,20P,1R,1.25mm,ANGLE,SN	
CN301	3711-002046	CONNECTOR-HEADER	3WALL,12P,1R,1.25mm,SMD-S,SN	SNA
CN601	3711-002050	CONNECTOR-HEADER	BOX,10P,1R,1.25mm,SMD-A,SN	SNA
CN901	3711-001141	CONNECTOR-HEADER	BOX,9P,1R,1.25mm,SMD-S,SN	SNA
CN903	3711-001141	CONNECTOR-HEADER	BOX,9P,1R,1.25mm,SMD-S,SN	SNA
CN904	3708-001776	CONNECTOR-FPC/FFC/PIC	34P,0.5MM,SMD-A,SN	
CN905	3708-001775	CONNECTOR-FPC/FFC/PIC	30P,0.5MM,SMD-A,SN	
CN951	3711-005085	CONNECTOR-HEADER	BOX,10P,1R,2.0MM,SMD-A,SN,BEG	
CN952	3711-005085	CONNECTOR-HEADER	BOX,10P,1R,2.0MM,SMD-A,SN,BEG	
CN953	3711-005085	CONNECTOR-HEADER	BOX,10P,1R,2.0MM,SMD-A,SN,BEG	
CN954	3711-005085	CONNECTOR-HEADER	BOX,10P,1R,2.0MM,SMD-A,SN,BEG	
CN955	3711-000556	CONNECTOR-HEADER	BOX,12P,1R,1.25mm,SMD-A,SN	SNA
D1	0401-001056	DIODE-SWITCHING	MMBD4148SE,75V,200MA,SOT-23,TP	
D2	0401-001056	DIODE-SWITCHING	MMBD4148SE,75V,200MA,SOT-23,TP	
D201	0401-001116	DIODE-SWITCHING	BAV99DW,75V,150MA,SOT-363,TP	
D202	0401-001116	DIODE-SWITCHING	BAV99DW,75V,150MA,SOT-363,TP	
D203	0401-001116	DIODE-SWITCHING	BAV99DW,75V,150MA,SOT-363,TP	
D204	0401-001116	DIODE-SWITCHING	BAV99DW,75V,150MA,SOT-363,TP	
D205	0401-001116	DIODE-SWITCHING	BAV99DW,75V,150MA,SOT-363,TP	
D206	0401-001116	DIODE-SWITCHING	BAV99DW,75V,150MA,SOT-363,TP	
D207	0401-001116	DIODE-SWITCHING	BAV99DW,75V,150MA,SOT-363,TP	
D208	0401-001116	DIODE-SWITCHING	BAV99DW,75V,150MA,SOT-363,TP	
D3	0401-001056	DIODE-SWITCHING	MMBD4148SE,75V,200MA,SOT-23,TP	
D333	0401-000133	DIODE-SWITCHING	RLS4148,100V,200MA,SOD-80C,TP	
D401	0401-001056	DIODE-SWITCHING	MMBD4148SE,75V,200MA,SOT-23,TP	
D402	0401-001056	DIODE-SWITCHING	MMBD4148SE,75V,200MA,SOT-23,TP	
D403	0401-001056	DIODE-SWITCHING	MMBD4148SE,75V,200MA,SOT-23,TP	
D404	0401-001056	DIODE-SWITCHING	MMBD4148SE,75V,200MA,SOT-23,TP	
D405	0401-001056	DIODE-SWITCHING	MMBD4148SE,75V,200MA,SOT-23,TP	
D406	0401-001056	DIODE-SWITCHING	MMBD4148SE,75V,200MA,SOT-23,TP	
D501	0401-001056	DIODE-SWITCHING	MMBD4148SE,75V,200MA,SOT-23,TP	
D502	0401-001056	DIODE-SWITCHING	MMBD4148SE,75V,200MA,SOT-23,TP	
D503	0401-001056	DIODE-SWITCHING	MMBD4148SE,75V,200MA,SOT-23,TP	
D504	0401-001056	DIODE-SWITCHING	MMBD4148SE,75V,200MA,SOT-23,TP	
D505	0401-001056	DIODE-SWITCHING	MMBD4148SE,75V,200MA,SOT-23,TP	
D506	0401-001056	DIODE-SWITCHING	MMBD4148SE,75V,200MA,SOT-23,TP	
D507	0401-001056	DIODE-SWITCHING	MMBD4148SE,75V,200MA,SOT-23,TP	
D508	0401-001056	DIODE-SWITCHING	MMBD4148SE,75V,200MA,SOT-23,TP	

Loc. No.	Code No.	Description	Specification	Remarks
D6	0401-001056	DIODE-SWITCHING	MMBD4148SE,75V,200MA,SOT-23,TP	
D7	0401-001056	DIODE-SWITCHING	MMBD4148SE,75V,200MA,SOT-23,TP	
D8	0401-001056	DIODE-SWITCHING	MMBD4148SE,75V,200MA,SOT-23,TP	
D9	0401-001056	DIODE-SWITCHING	MMBD4148SE,75V,200MA,SOT-23,TP	
D901	0404-001084	DIODE-SCHOTTKY	BAT54A,30V,200MA,SOT-23,TP	
D902	0404-001055	DIODE-SCHOTTKY	-,60V,3000MA,SMC,TP	
D903	0404-001055	DIODE-SCHOTTKY	-,60V,3000MA,SMC,TP	
D904	0401-000133	DIODE-SWITCHING	RLS4148,100V,200MA,SOD-80C,TP	
FT1	2909-001051	FILTER-LC	6MHz,6MHz,0.8dB,TP,5dB/6MHz,30dB/14.3MHz	
FT1001	3301-001145	CORE-FERRITE BEAD	AB,4.5x1.6x1.6mm,-,-	SNA
FT101	2901-001114	FILTER-EMI SMD	25VDC,2.0ADC,-,100nF,3.2x1.6x1	
FT102	2901-001114	FILTER-EMI SMD	25VDC,2.0ADC,-,100nF,3.2x1.6x1	
FT103	2901-001114	FILTER-EMI SMD	25VDC,2.0ADC,-,100nF,3.2x1.6x1	
FT104	2901-001114	FILTER-EMI SMD	25VDC,2.0ADC,-,100nF,3.2x1.6x1	
FT105	2901-001114	FILTER-EMI SMD	25VDC,2.0ADC,-,100nF,3.2x1.6x1	
FT106	2901-001114	FILTER-EMI SMD	25VDC,2.0ADC,-,100nF,3.2x1.6x1	
FT108	2901-001114	FILTER-EMI SMD	25VDC,2.0ADC,-,100nF,3.2x1.6x1	
FT109	2901-001114	FILTER-EMI SMD	25VDC,2.0ADC,-,100nF,3.2x1.6x1	
FT110	2901-001114	FILTER-EMI SMD	25VDC,2.0ADC,-,100nF,3.2x1.6x1	
FT1111	3301-001145	CORE-FERRITE BEAD	AB,4.5x1.6x1.6mm,-,-	SNA
FT2	2909-001051	FILTER-LC	6MHz,6MHz,0.8dB,TP,5dB/6MHz,30dB/14.3MHz	
FT201	2901-001114	FILTER-EMI SMD	25VDC,2.0ADC,-,100nF,3.2x1.6x1	
FT202	2901-001114	FILTER-EMI SMD	25VDC,2.0ADC,-,100nF,3.2x1.6x1	
FT203	2901-001114	FILTER-EMI SMD	25VDC,2.0ADC,-,100nF,3.2x1.6x1	
FT204	2901-001114	FILTER-EMI SMD	25VDC,2.0ADC,-,100nF,3.2x1.6x1	
FT205	2901-001114	FILTER-EMI SMD	25VDC,2.0ADC,-,100nF,3.2x1.6x1	
FT206	2901-001114	FILTER-EMI SMD	25VDC,2.0ADC,-,100nF,3.2x1.6x1	
FT209	2901-001114	FILTER-EMI SMD	25VDC,2.0ADC,-,100nF,3.2x1.6x1	
FT220	2901-001114	FILTER-EMI SMD	25VDC,2.0ADC,-,100nF,3.2x1.6x1	
FT3	2909-001051	FILTER-LC	6MHz,6MHz,0.8dB,TP,5dB/6MHz,30dB/14.3MHz	
FT302	2901-001114	FILTER-EMI SMD	25VDC,2.0ADC,-,100nF,3.2x1.6x1	
FT401	2901-001114	FILTER-EMI SMD	25VDC,2.0ADC,-,100nF,3.2x1.6x1	
FT402	2901-001114	FILTER-EMI SMD	25VDC,2.0ADC,-,100nF,3.2x1.6x1	
FT403	2901-001114	FILTER-EMI SMD	25VDC,2.0ADC,-,100nF,3.2x1.6x1	
FT404	2901-001114	FILTER-EMI SMD	25VDC,2.0ADC,-,100nF,3.2x1.6x1	
FT601	2901-001114	FILTER-EMI SMD	25VDC,2.0ADC,-,100nF,3.2x1.6x1	
FT602	2901-001114	FILTER-EMI SMD	25VDC,2.0ADC,-,100nF,3.2x1.6x1	
FT603	2901-001114	FILTER-EMI SMD	25VDC,2.0ADC,-,100nF,3.2x1.6x1	
FT604	2901-001114	FILTER-EMI SMD	25VDC,2.0ADC,-,100nF,3.2x1.6x1	
FT605	2901-001114	FILTER-EMI SMD	25VDC,2.0ADC,-,100nF,3.2x1.6x1	
FT606	2901-001114	FILTER-EMI SMD	25VDC,2.0ADC,-,100nF,3.2x1.6x1	
FT607	2901-001114	FILTER-EMI SMD	25VDC,2.0ADC,-,100nF,3.2x1.6x1	
FT608	2901-001114	FILTER-EMI SMD	25VDC,2.0ADC,-,100nF,3.2x1.6x1	
FT609	2901-001114	FILTER-EMI SMD	25VDC,2.0ADC,-,100nF,3.2x1.6x1	
FT701	2901-001114	FILTER-EMI SMD	25VDC,2.0ADC,-,100nF,3.2x1.6x1	
FT702	2901-001114	FILTER-EMI SMD	25VDC,2.0ADC,-,100nF,3.2x1.6x1	
FT703	2901-001114	FILTER-EMI SMD	25VDC,2.0ADC,-,100nF,3.2x1.6x1	
FT704	2901-001114	FILTER-EMI SMD	25VDC,2.0ADC,-,100nF,3.2x1.6x1	
FT705	2901-001114	FILTER-EMI SMD	25VDC,2.0ADC,-,100nF,3.2x1.6x1	
FT706	3301-001145	CORE-FERRITE BEAD	AB,4.5x1.6x1.6mm,-,-	SNA
FT801	2901-001114	FILTER-EMI SMD	25VDC,2.0ADC,-,100nF,3.2x1.6x1	
FT802	2901-001114	FILTER-EMI SMD	25VDC,2.0ADC,-,100nF,3.2x1.6x1	
FT803	2901-001114	FILTER-EMI SMD	25VDC,2.0ADC,-,100nF,3.2x1.6x1	
FT804	2901-001114	FILTER-EMI SMD	25VDC,2.0ADC,-,100nF,3.2x1.6x1	
FT805	2901-001114	FILTER-EMI SMD	25VDC,2.0ADC,-,100nF,3.2x1.6x1	
FT806	2901-001114	FILTER-EMI SMD	25VDC,2.0ADC,-,100nF,3.2x1.6x1	
FT807	2901-001114	FILTER-EMI SMD	25VDC,2.0ADC,-,100nF,3.2x1.6x1	
FT808	2901-001114	FILTER-EMI SMD	25VDC,2.0ADC,-,100nF,3.2x1.6x1	
FT901	2901-001114	FILTER-EMI SMD	25VDC,2.0ADC,-,100nF,3.2x1.6x1	
FT903	3301-001145	CORE-FERRITE BEAD	AB,4.5x1.6x1.6mm,-,-	SNA
FT950	3301-001145	CORE-FERRITE BEAD	AB,4.5x1.6x1.6mm,-,-	SNA
FT951	3301-001145	CORE-FERRITE BEAD	AB,4.5x1.6x1.6mm,-,-	SNA
FT952	3301-001145	CORE-FERRITE BEAD	AB,4.5x1.6x1.6mm,-,-	SNA
FT953	3301-001145	CORE-FERRITE BEAD	AB,4.5x1.6x1.6mm,-,-	SNA
FT954	3301-001145	CORE-FERRITE BEAD	AB,4.5x1.6x1.6mm,-,-	SNA
FT955	3301-001145	CORE-FERRITE BEAD	AB,4.5x1.6x1.6mm,-,-	SNA
FT956	3301-001145	CORE-FERRITE BEAD	AB,4.5x1.6x1.6mm,-,-	SNA
FT957	3301-001145	CORE-FERRITE BEAD	AB,4.5x1.6x1.6mm,-,-	SNA
FT958	3301-001145	CORE-FERRITE BEAD	AB,4.5x1.6x1.6mm,-,-	SNA
FT959	3301-001145	CORE-FERRITE BEAD	AB,4.5x1.6x1.6mm,-,-	SNA



Loc. No.	Code No.	Description	Specification	Remarks
FT960	3301-001145	CORE-FERRITE BEAD	AB,4.5x1.6x1.6mm,-,-	SNA
FT961	3301-001145	CORE-FERRITE BEAD	AB,4.5x1.6x1.6mm,-,-	SNA
FT962	3301-001145	CORE-FERRITE BEAD	AB,4.5x1.6x1.6mm,-,-	SNA
FT963	3301-001145	CORE-FERRITE BEAD	AB,4.5x1.6x1.6mm,-,-	SNA
FT964	3301-001145	CORE-FERRITE BEAD	AB,4.5x1.6x1.6mm,-,-	SNA
FT965	3301-001145	CORE-FERRITE BEAD	AB,4.5x1.6x1.6mm,-,-	SNA
FT966	3301-001145	CORE-FERRITE BEAD	AB,4.5x1.6x1.6mm,-,-	SNA
FT967	3301-001145	CORE-FERRITE BEAD	AB,4.5x1.6x1.6mm,-,-	SNA
FT969	3301-001145	CORE-FERRITE BEAD	AB,4.5x1.6x1.6mm,-,-	SNA
FT970	3301-001145	CORE-FERRITE BEAD	AB,4.5x1.6x1.6mm,-,-	SNA
FT972	3301-001145	CORE-FERRITE BEAD	AB,4.5x1.6x1.6mm,-,-	SNA
FT973	3301-001145	CORE-FERRITE BEAD	AB,4.5x1.6x1.6mm,-,-	SNA
FT976	3301-001145	CORE-FERRITE BEAD	AB,4.5x1.6x1.6mm,-,-	SNA
FT977	3301-001145	CORE-FERRITE BEAD	AB,4.5x1.6x1.6mm,-,-	SNA
FT978	3301-001145	CORE-FERRITE BEAD	AB,4.5x1.6x1.6mm,-,-	SNA
FT979	3301-001145	CORE-FERRITE BEAD	AB,4.5x1.6x1.6mm,-,-	SNA
IC1001	1203-001448	IC-SWITCH VOL. REG.	2596,TO-263,5P,-,PLASTIC,4.750	
IC1002	1204-001814	IC-SELECTOR	CXA2151Q,QFP,48P,144MIL,PLASTIC,5.5V,1.4W,-,22TO+75C,TR,-	
IC101	1203-001559	IC-RESET	DS1834,SOIC,8P,150MIL,-,1.2/5V	
IC102	1103-001223	IC-EEPROM	24C16,2048x8BIT,SOP,8P,150MIL,10mS,2.7V,-,PLASTIC,0to+70C,4uA,CMOS,TP	
IC103	0903-001202	IC-MICROCONTROLLER	80251G2,8BIT,PLCC,44P,653MIL,24MHz,TR,CMOS,PLASTIC,5V,1.5W,0to+70C,1KBYTE,-,24Bi	SNA
IC104	0801-002559	IC-CMOS LOGIC	74LVX74,D FLIP-FLOP,TSSOP,14P,173MIL,DUAL,TP,PLASTIC,-,-,0.36V,-,40to+85C,180mW,2	
IC105_SOCKET	3704-000249	SOCKET-IC	32P,PLCC,SN,1.27mm	
IC106	0801-002574	IC-CMOS LOGIC	74LVX04,INVERTER,SOP,14P,150MIL,HEX,TP,PLASTIC,-,-,0.36V,-,40to+85C,180mW,2.4V,20	
IC107	0801-002394	IC-CMOS LOGIC	74LXCX32,OR GATE,SOIC,14P,150MI	
IC109	0801-002576	IC-CMOS LOGIC	74LVX373,LATCH,SOP,20P,300MIL,OCTAL,TP,PLASTIC,3-STATE,-,0.36V,-,40to+85C,180mW,2	
IC110	0801-002268	IC-CMOS LOGIC	74VHC139,DECODER,SOP,16P,150MI	
IC111	0909-001036	IC-REAL TIME CLOCK	DS1337S,-,SO,8P,150MIL,400KHZ,TP,CMOS,PLASTIC,3.3V,-,-,40TO+85C,-,-,-,-,-	
IC112	0801-002394	IC-CMOS LOGIC	74LXCX32,OR GATE,SOIC,14P,150MI	
IC2	1204-001935	IC-SEPARATOR	UPD64083GF,QFP,100P,14X20MM,PLASTIC,3.6V,-,0TO+70C,TP,UPD64083GF	
IC201	1203-002067	IC-POSI.FIXED REG.	3330,SOT-23,6P,65MIL,PLASTIC,3.284/3.316V,-,-,40to+125C,200mA,-,TP	
IC202	1203-002067	IC-POSI.FIXED REG.	3330,SOT-23,6P,65MIL,PLASTIC,3.284/3.316V,-,-,40to+125C,200mA,-,TP	
IC203	1002-001292	IC-A/D CONVERTER	AD9883AKST-110,8BITS,QFP,80P,551MIL,æ0.5LSB,TR,CMOS,PLASTIC,3.3V,-,25TO+85C,650M	
IC204	1205-002183	IC-RECEIVER	SI1161BCT100,TOFP,100P,14X14MM,PLASTIC,3.6V,-,0TO+70C,TR,PANELINK	
IC205	0801-002267	IC-CMOS LOGIC	74LXCX14,-,SOIC,14P,150MIL,-,TP,-,-,-,3.6V,-,40TO+85C,-,-,5.5V,-,-,24MA	
IC206	1203-002067	IC-POSI.FIXED REG.	3330,SOT-23,6P,65MIL,PLASTIC,3.284/3.316V,-,-,40to+125C,200mA,-,TP	
IC207	1103-000129	IC-EEPROM	24C02,256x8BIT,SOP,8P,150MIL,1	
IC301	1203-002454	IC-VOLTAGE REGULATOR	FAN1117A,TO-252,3P,257MIL,PLASTIC,1.764V/1.836V,-,0TO+125C,1A,1.225/1.275V,TP	
IC302	1204-001973	IC-DECODER	VSP9437B,MQFP,80P,14X14MM,PLASTIC,3.47V,1.6W,0TO+70C,TR,VSP9437B	
IC303	1301-001543	IC-CPLD	EPM3032A,TOFP,44P,-,10NS,3.3V,10%,-,0TO+70C,PLASTIC,34,34,2,125MHZ,3.725V,-,-,10	
IC304	1001-001146	IC-ANALOG SWITCH	FST3257,BUS SWITCH & CMOS,SOP,16P,150MIL,QUAD,5.5V,-,40to+85C,PLASTIC,-,15ohm,-,-	
IC306	1001-001082	IC-VIDEO SWITCH	BA7657F,-,SOP,24P,300MIL,SINGL	
IC401	1203-002067	IC-POSI.FIXED REG.	3330,SOT-23,6P,65MIL,PLASTIC,3.284/3.316V,-,-,40to+125C,200mA,-,TP	
IC402	1203-002067	IC-POSI.FIXED REG.	3330,SOT-23,6P,65MIL,PLASTIC,3.284/3.316V,-,-,40to+125C,200mA,-,TP	
IC403	1001-001082	IC-VIDEO SWITCH	BA7657F,-,SOP,24P,300MIL,SINGL	
IC404	1002-001292	IC-A/D CONVERTER	AD9883AKST-110,8BITS,QFP,80P,551MIL,æ0.5LSB,TR,CMOS,PLASTIC,3.3V,-,25TO+85C,650M	
IC405	0801-002559	IC-CMOS LOGIC	74LVX74,D FLIP-FLOP,TSSOP,14P,173MIL,DUAL,TP,PLASTIC,-,-,0.36V,-,40to+85C,180mW,2	
IC406	1001-001146	IC-ANALOG SWITCH	FST3257,BUS SWITCH & CMOS,SOP,16P,150MIL,QUAD,5.5V,-,40to+85C,PLASTIC,-,15ohm,-,-	
IC501	1203-001816	IC-POSI.FIXED REG.	78M08,TO-252,3P,-,PLASTIC,7.7/8.3V,1.0W,-,40TO+85C,0.5A,-,TP	
IC502	1203-001488	IC-POSI.FIXED REG.	7805,TO-252,3P,-,PLASTIC,4.8/5	
IC503	1204-001675	IC-SOUND PROCESSOR	MSP3451G,QFP,80P,-,PLASTIC,9V,1000mW,0to+70C,TR,Multistandard Sound	
IC504	1201-001681	IC-AUDIO AMP	1101,SOP,30P,433MIL,-,-,PLASTIC,13.2V,-,-,0to+70C,-,-,-,-,-,TP	
IC505	1201-001495	IC-AUDIO AMP	7050,SOP,8P,150MIL,DUAL,26DB,PLASTIC,6V,0.25W,-,40DB,-,-,20NA,-	
IC601	1105-001336	IC-DRAM	4S643232,512Kx32x4Bit,TSOP,86P,400MIL,60nS,3.3V,10%,PLASTIC,0to+70C,2mA,CMOS,TP	
IC602	1105-001336	IC-DRAM	4S643232,512Kx32x4Bit,TSOP,86P,400MIL,60nS,3.3V,10%,PLASTIC,0to+70C,2mA,CMOS,TP	
IC603	1205-002028	IC-LCD CONTROLLER	JAGASM,BGA,388P,208MIL,PALATIC,3.45V,2.5W,-,40TO+125C,TR,DIGITAL DISPLAY PRO.	
IC604	0801-002267	IC-CMOS LOGIC	74LXCX14,-,SOIC,14P,150MIL,-,TP,-,-,-,3.6V,-,40TO+85C,-,-,5.5V,-,-,24MA	
IC701	1001-001146	IC-ANALOG SWITCH	FST3257,BUS SWITCH & CMOS,SOP,16P,150MIL,QUAD,5.5V,-,40to+85C,PLASTIC,-,15ohm,-,-	
IC702	1001-001190	IC-ANALOG SWITCH	FST16233MTD,BUS SWITCH,TSSOP,56P,240MIL,-,5.5V,-,40TO+85C,PLASTIC,-,200HM,8.5NS,7	
IC703	1204-002019	IC-VIDEO PROCESS	MDIN-100,QFP,256P,28X28MM,PLASTIC,3.3V,-,0TO+70C,TR,-	
IC704	1105-001336	IC-DRAM	4S643232,512Kx32x4Bit,TSOP,86P,400MIL,60nS,3.3V,10%,PLASTIC,0to+70C,2mA,CMOS,TP	
IC801	1205-002028	IC-LCD CONTROLLER	JAGASM,BGA,388P,208MIL,PALATIC,3.45V,2.5W,-,40TO+125C,TR,DIGITAL DISPLAY PRO.	
IC802	1105-001336	IC-DRAM	4S643232,512Kx32x4Bit,TSOP,86P,400MIL,60nS,3.3V,10%,PLASTIC,0to+70C,2mA,CMOS,TP	
IC803	1105-001336	IC-DRAM	4S643232,512Kx32x4Bit,TSOP,86P,400MIL,60nS,3.3V,10%,PLASTIC,0to+70C,2mA,CMOS,TP	
IC904	1203-001432	IC-POSI.FIXED REG.	78M12,DPAK,3P,-,PLASTIC,11.5/1	
IC905	0505-000275	FET-SILICON	SI4435DY,P,-,30V,+8.0A,0.014ohm,2.5W,SO-8	
IC906	1203-002191	IC-DC/DC CONVERTER	LTC1778,SSOP,16P,153MIL,PLASTIC,-,-,125C,-,-,TP	
IC950	1203-001465	IC-POSI.ADJUST REG.	317,TO-263,3P,-,PLASTIC,1.2/37	
IC951	1203-001448	IC-SWITCH VOL. REG.	2596,TO-263,5P,-,PLASTIC,4.750	
IC952	1203-001448	IC-SWITCH VOL. REG.	2596,TO-263,5P,-,PLASTIC,4.750	

Loc. No.	Code No.	Description	Specification	Remarks
IC953	1203-002411	IC-POSI.FIXED REG.	IRU1030-33CM,TO-263,3P,-,PLASTIC,3.267/3.333V,-,0TO+150C,-,-,ST	
IC954	1203-002411	IC-POSI.FIXED REG.	IRU1030-33CM,TO-263,3P,-,PLASTIC,3.267/3.333V,-,0TO+150C,-,-,ST	
IC955	1203-001448	IC-SWITCH VOL. REG.	2596,TO-263,5P,-,PLASTIC,4.750	
IC956	1203-002411	IC-POSI.FIXED REG.	IRU1030-33CM,TO-263,3P,-,PLASTIC,3.267/3.333V,-,0TO+150C,-,-,ST	
IC957	1203-002411	IC-POSI.FIXED REG.	IRU1030-33CM,TO-263,3P,-,PLASTIC,3.267/3.333V,-,0TO+150C,-,-,ST	
IC958	1203-001448	IC-SWITCH VOL. REG.	2596,TO-263,5P,-,PLASTIC,4.750	
IC959	1203-001815	IC-POSI.FIXED REG.	78M09,TO-252,3P,-,PLASTIC,8.6/9.4V,1.0W,-40TO+85C,0.5A,-,TP	
IC960	1203-001815	IC-POSI.FIXED REG.	78M09,TO-252,3P,-,PLASTIC,8.6/9.4V,1.0W,-40TO+85C,0.5A,-,TP	
IC961	1203-001465	IC-POSI.ADJUST REG.	317,TO-263,3P,-,PLASTIC,1.2/37	
IC962	1203-002199	IC-POSI.FIXED REG.	LM2596,TO-263,5P,340MIL,PALSTIC,-,-,-40TO+125C,-,-,ST	
IC963	0505-001170	FET-SILICON	SI9933ADY-T1,P,-,20V,3.4A,0.06ohm,2W,SO-8	
IC964	1203-001465	IC-POSI.ADJUST REG.	317,TO-263,3P,-,PLASTIC,1.2/37	
IC965	1203-002199	IC-POSI.FIXED REG.	LM2596,TO-263,5P,340MIL,PALSTIC,-,-,-40TO+125C,-,-,ST	
L1	2703-000398	INDUCTOR-SMD	10uH,10%,3.2x2.5x2.2mm	
L10	2703-000398	INDUCTOR-SMD	10uH,10%,3.2x2.5x2.2mm	
L1001	2703-001334	INDUCTOR-SMD	1.5uH,10%,2x1.25x0.85mm	
L1002	BN27-00002A	COIL-CHOKE(SMD)	47uH,47uH,20%,12*12*8mm,22.5Ts,SMD,-,-,0.75ohm,-,-,TP	
L101	2703-001334	INDUCTOR-SMD	1.5uH,10%,2x1.25x0.85mm	
L11	2703-000398	INDUCTOR-SMD	10uH,10%,3.2x2.5x2.2mm	
L12	2703-001778	INDUCTOR-SMD	3.3UH,20%,3.2X2.5X2.2MM	
L14	2703-000398	INDUCTOR-SMD	10uH,10%,3.2x2.5x2.2mm	
L16	2703-000398	INDUCTOR-SMD	10uH,10%,3.2x2.5x2.2mm	
L17	2703-000398	INDUCTOR-SMD	10uH,10%,3.2x2.5x2.2mm	
L18	2703-000398	INDUCTOR-SMD	10uH,10%,3.2x2.5x2.2mm	
L19	2703-000398	INDUCTOR-SMD	10uH,10%,3.2x2.5x2.2mm	
L2	2703-000398	INDUCTOR-SMD	10uH,10%,3.2x2.5x2.2mm	
L204	2703-001334	INDUCTOR-SMD	1.5uH,10%,2x1.25x0.85mm	
L27	2703-000398	INDUCTOR-SMD	10uH,10%,3.2x2.5x2.2mm	
L28	2703-000398	INDUCTOR-SMD	10uH,10%,3.2x2.5x2.2mm	
L3	2703-000398	INDUCTOR-SMD	10uH,10%,3.2x2.5x2.2mm	
L301	2703-001778	INDUCTOR-SMD	3.3UH,20%,3.2X2.5X2.2MM	
L302	2703-001778	INDUCTOR-SMD	3.3UH,20%,3.2X2.5X2.2MM	
L4	2703-001896	INDUCTOR-SMD	10uH,5%,3.2x2.5x2.2mm	
L401	2703-001334	INDUCTOR-SMD	1.5uH,10%,2x1.25x0.85mm	
L501	2703-001778	INDUCTOR-SMD	3.3UH,20%,3.2X2.5X2.2MM	
L502	BN27-00007A	COIL CHOKE-SMD	DHB0504-100,RB15/17NS,10UH,*æ10%,-,0.080HM,1.5A,DR5.8X4.5,20.5TS,6.0X5.2X4.5MM,-	
L503	BN27-00007A	COIL CHOKE-SMD	DHB0504-100,RB15/17NS,10UH,*æ10%,-,0.080HM,1.5A,DR5.8X4.5,20.5TS,6.0X5.2X4.5MM,-	
L504	BN27-00007A	COIL CHOKE-SMD	DHB0504-100,RB15/17NS,10UH,*æ10%,-,0.080HM,1.5A,DR5.8X4.5,20.5TS,6.0X5.2X4.5MM,-	
L505	BN27-00007A	COIL CHOKE-SMD	DHB0504-100,RB15/17NS,10UH,*æ10%,-,0.080HM,1.5A,DR5.8X4.5,20.5TS,6.0X5.2X4.5MM,-	
L506	2703-001778	INDUCTOR-SMD	3.3UH,20%,3.2X2.5X2.2MM	
L6	2703-000398	INDUCTOR-SMD	10uH,10%,3.2x2.5x2.2mm	
L701	2703-001778	INDUCTOR-SMD	3.3UH,20%,3.2X2.5X2.2MM	
L702	2703-001778	INDUCTOR-SMD	3.3UH,20%,3.2X2.5X2.2MM	
L9	2703-000398	INDUCTOR-SMD	10uH,10%,3.2x2.5x2.2mm	
MP1.0	BN41-00193A	PCB-MAIN	LT29A13W,FR-4,4L,A,1.6T,330X210,APOLLO2,1A	
Q1	0501-000280	TR-SMALL SIGNAL	KSA1182,P.NP,150mW,SOT-23,TP,70	
Q10	0501-000280	TR-SMALL SIGNAL	KSA1182,P.NP,150mW,SOT-23,TP,70	
Q1001	0501-002080	TR-SMALL SIGNAL	2SC2412K,NPN,200mW,SC-59,TP,120-270	
Q101	0501-002080	TR-SMALL SIGNAL	2SC2412K,NPN,200mW,SC-59,TP,120-270	
Q11	0501-000280	TR-SMALL SIGNAL	KSA1182,P.NP,150mW,SOT-23,TP,70	
Q12	0501-002080	TR-SMALL SIGNAL	2SC2412K,NPN,200mW,SC-59,TP,120-270	
Q13	0501-000280	TR-SMALL SIGNAL	KSA1182,P.NP,150mW,SOT-23,TP,70	
Q14	0501-002080	TR-SMALL SIGNAL	2SC2412K,NPN,200mW,SC-59,TP,120-270	
Q15	0501-002080	TR-SMALL SIGNAL	2SC2412K,NPN,200mW,SC-59,TP,120-270	
Q16	0501-000280	TR-SMALL SIGNAL	KSA1182,P.NP,150mW,SOT-23,TP,70	
Q2	0501-002080	TR-SMALL SIGNAL	2SC2412K,NPN,200mW,SC-59,TP,120-270	
Q3	0501-002080	TR-SMALL SIGNAL	2SC2412K,NPN,200mW,SC-59,TP,120-270	
Q4	0501-000280	TR-SMALL SIGNAL	KSA1182,P.NP,150mW,SOT-23,TP,70	
Q5	0501-000280	TR-SMALL SIGNAL	KSA1182,P.NP,150mW,SOT-23,TP,70	
Q501	0501-002080	TR-SMALL SIGNAL	2SC2412K,NPN,200mW,SC-59,TP,120-270	
Q6	0501-002080	TR-SMALL SIGNAL	2SC2412K,NPN,200mW,SC-59,TP,120-270	
Q7	0501-000280	TR-SMALL SIGNAL	KSA1182,P.NP,150mW,SOT-23,TP,70	
Q8	0501-000280	TR-SMALL SIGNAL	KSA1182,P.NP,150mW,SOT-23,TP,70	
Q901	0501-002080	TR-SMALL SIGNAL	2SC2412K,NPN,200mW,SC-59,TP,120-270	
Q902	0505-001663	FET-SILICON	F0B50N06L,N,60V,52.4,0.021OHM,3.75W,D-PAK	
Q903	0505-001663	FET-SILICON	F0B50N06L,N,60V,52.4,0.021OHM,3.75W,D-PAK	
Q904	0505-001662	FET-SILICON	FDB5645,N,60V,80A,0.0095OHM,125W,TO-263AB	
Q905	0505-001662	FET-SILICON	FDB5645,N,60V,80A,0.0095OHM,125W,TO-263AB	
Q950	0501-002080	TR-SMALL SIGNAL	2SC2412K,NPN,200mW,SC-59,TP,120-270	
Q951	0501-002080	TR-SMALL SIGNAL	2SC2412K,NPN,200mW,SC-59,TP,120-270	

SNA

Loc. No.	Code No.	Description	Specification	Remarks
Q952	0501-002080	TR-SMALL SIGNAL	2SC2412K,NPN,200mW,SC-59,TP,120-270	
Q953	0501-002080	TR-SMALL SIGNAL	2SC2412K,NPN,200mW,SC-59,TP,120-270	
Q954	0501-002080	TR-SMALL SIGNAL	2SC2412K,NPN,200mW,SC-59,TP,120-270	
Q955	0501-002080	TR-SMALL SIGNAL	2SC2412K,NPN,200mW,SC-59,TP,120-270	
Q956	0501-002080	TR-SMALL SIGNAL	2SC2412K,NPN,200mW,SC-59,TP,120-270	
R1	2007-000070	R-CHIP	0ohm,5%,1/16W,DA,TP,1608	
R10	2007-000074	R-CHIP	100ohm,5%,1/16W,DA,TP,1608	
R1001	2007-000084	R-CHIP	4.7Kohm,5%,1/16W,DA,TP,1608	
R1002	2007-000084	R-CHIP	4.7Kohm,5%,1/16W,DA,TP,1608	
R1003	2007-000074	R-CHIP	100ohm,5%,1/16W,DA,TP,1608	
R1004	2007-000090	R-CHIP	10KOHM,5%,1/16W,DA,TP,1608	
R1005	2007-000090	R-CHIP	10KOHM,5%,1/16W,DA,TP,1608	
R1006	2007-000071	R-CHIP	22ohm,5%,1/16W,DA,TP,1608	
R1007	2007-000071	R-CHIP	22ohm,5%,1/16W,DA,TP,1608	
R1008	2007-000071	R-CHIP	22ohm,5%,1/16W,DA,TP,1608	
R1009	2007-001167	R-CHIP	75ohm,5%,1/16W,DA,TP,1608	
R101	2007-000090	R-CHIP	10KOHM,5%,1/16W,DA,TP,1608	
R1010	2007-000071	R-CHIP	22ohm,5%,1/16W,DA,TP,1608	
R1011	2007-001167	R-CHIP	75ohm,5%,1/16W,DA,TP,1608	
R1012	2007-000071	R-CHIP	22ohm,5%,1/16W,DA,TP,1608	
R1013	2007-001167	R-CHIP	75ohm,5%,1/16W,DA,TP,1608	
R1014	2007-001167	R-CHIP	75ohm,5%,1/16W,DA,TP,1608	
R1015	2007-001167	R-CHIP	75ohm,5%,1/16W,DA,TP,1608	
R1016	2007-001167	R-CHIP	75ohm,5%,1/16W,DA,TP,1608	
R1017	2007-001167	R-CHIP	75ohm,5%,1/16W,DA,TP,1608	
R1018	2007-001167	R-CHIP	75ohm,5%,1/16W,DA,TP,1608	
R1019	2007-001167	R-CHIP	75ohm,5%,1/16W,DA,TP,1608	
R102	2007-000084	R-CHIP	4.7Kohm,5%,1/16W,DA,TP,1608	
R1020	2007-001167	R-CHIP	75ohm,5%,1/16W,DA,TP,1608	
R1021	2007-001167	R-CHIP	75ohm,5%,1/16W,DA,TP,1608	
R1022	2007-001167	R-CHIP	75ohm,5%,1/16W,DA,TP,1608	
R1023	2007-001167	R-CHIP	75ohm,5%,1/16W,DA,TP,1608	
R1024	2007-001167	R-CHIP	75ohm,5%,1/16W,DA,TP,1608	
R1025	2007-000071	R-CHIP	22ohm,5%,1/16W,DA,TP,1608	
R1026	2007-000071	R-CHIP	22ohm,5%,1/16W,DA,TP,1608	
R1027	2007-001167	R-CHIP	75ohm,5%,1/16W,DA,TP,1608	
R1028	2007-000071	R-CHIP	22ohm,5%,1/16W,DA,TP,1608	
R1029	2007-000071	R-CHIP	22ohm,5%,1/16W,DA,TP,1608	
R103	2007-000092	R-CHIP	15Kohm,5%,1/16W,DA,TP,1608	
R1030	2007-001167	R-CHIP	75ohm,5%,1/16W,DA,TP,1608	
R1031	2007-000071	R-CHIP	22ohm,5%,1/16W,DA,TP,1608	
R1032	2007-000071	R-CHIP	22ohm,5%,1/16W,DA,TP,1608	
R1033	2007-000071	R-CHIP	22ohm,5%,1/16W,DA,TP,1608	
R1034	2007-000071	R-CHIP	22ohm,5%,1/16W,DA,TP,1608	
R104	2007-000070	R-CHIP	0ohm,5%,1/16W,DA,TP,1608	
R105	2007-000084	R-CHIP	4.7Kohm,5%,1/16W,DA,TP,1608	
R1051	2007-000074	R-CHIP	100ohm,5%,1/16W,DA,TP,1608	
R1052	2007-000074	R-CHIP	100ohm,5%,1/16W,DA,TP,1608	
R106	2007-000084	R-CHIP	4.7Kohm,5%,1/16W,DA,TP,1608	
R107	2007-000084	R-CHIP	4.7Kohm,5%,1/16W,DA,TP,1608	
R108	2007-000084	R-CHIP	4.7Kohm,5%,1/16W,DA,TP,1608	
R109	2007-000084	R-CHIP	4.7Kohm,5%,1/16W,DA,TP,1608	
R11	2007-001167	R-CHIP	75ohm,5%,1/16W,DA,TP,1608	
R110	2007-000084	R-CHIP	4.7Kohm,5%,1/16W,DA,TP,1608	
R111	2007-000084	R-CHIP	4.7Kohm,5%,1/16W,DA,TP,1608	
R112	2007-000084	R-CHIP	4.7Kohm,5%,1/16W,DA,TP,1608	
R113	2007-000070	R-CHIP	0ohm,5%,1/16W,DA,TP,1608	
R114	2007-000239	R-CHIP	1.5Kohm,1%,1/16W,DA,TP,1608	
R115	2007-000239	R-CHIP	1.5Kohm,1%,1/16W,DA,TP,1608	
R116	2007-000070	R-CHIP	0ohm,5%,1/16W,DA,TP,1608	
R117	2007-000075	R-CHIP	220ohm,5%,1/16W,DA,TP,1608	
R118	2007-000075	R-CHIP	220ohm,5%,1/16W,DA,TP,1608	
R119	2007-000070	R-CHIP	0ohm,5%,1/16W,DA,TP,1608	
R12	2007-001167	R-CHIP	75ohm,5%,1/16W,DA,TP,1608	
R120	2007-000070	R-CHIP	0ohm,5%,1/16W,DA,TP,1608	
R121	2007-000090	R-CHIP	10KOHM,5%,1/16W,DA,TP,1608	
R122	2007-000071	R-CHIP	22ohm,5%,1/16W,DA,TP,1608	
R123	2007-000071	R-CHIP	22ohm,5%,1/16W,DA,TP,1608	
R124	2007-000075	R-CHIP	220ohm,5%,1/16W,DA,TP,1608	
R125	2007-000075	R-CHIP	220ohm,5%,1/16W,DA,TP,1608	

Loc. No.	Code No.	Description	Specification	Remarks
R126	2007-000078	R-CHIP	1Kohm,5%,1/16W,DA,TP,1608	
R127	2007-000078	R-CHIP	1Kohm,5%,1/16W,DA,TP,1608	
R1277	2007-000084	R-CHIP	4.7Kohm,5%,1/16W,DA,TP,1608	
R1278	2007-000090	R-CHIP	10KOHM,5%,1/16W,DA,TP,1608	
R128	2007-000070	R-CHIP	0ohm,5%,1/16W,DA,TP,1608	
R129	2007-000084	R-CHIP	4.7Kohm,5%,1/16W,DA,TP,1608	
R13	2007-001167	R-CHIP	75ohm,5%,1/16W,DA,TP,1608	
R130	2007-000070	R-CHIP	0ohm,5%,1/16W,DA,TP,1608	
R131	2007-000084	R-CHIP	4.7Kohm,5%,1/16W,DA,TP,1608	
R132	2007-000084	R-CHIP	4.7Kohm,5%,1/16W,DA,TP,1608	
R134	2007-000084	R-CHIP	4.7Kohm,5%,1/16W,DA,TP,1608	
R136	2007-000084	R-CHIP	4.7Kohm,5%,1/16W,DA,TP,1608	
R137	2007-000084	R-CHIP	4.7Kohm,5%,1/16W,DA,TP,1608	
R138	2007-000084	R-CHIP	4.7Kohm,5%,1/16W,DA,TP,1608	
R139	2007-000084	R-CHIP	4.7Kohm,5%,1/16W,DA,TP,1608	
R14	2007-000097	R-CHIP	47Kohm,5%,1/16W,DA,TP,1608	
R142	2007-000071	R-CHIP	22ohm,5%,1/16W,DA,TP,1608	
R143	2007-000071	R-CHIP	22ohm,5%,1/16W,DA,TP,1608	
R15	2007-000078	R-CHIP	1Kohm,5%,1/16W,DA,TP,1608	
R16	2007-000084	R-CHIP	4.7Kohm,5%,1/16W,DA,TP,1608	
R17	2007-000074	R-CHIP	100ohm,5%,1/16W,DA,TP,1608	
R18	2007-000102	R-CHIP	100Kohm,5%,1/16W,DA,TP,1608	
R19	2007-000074	R-CHIP	100ohm,5%,1/16W,DA,TP,1608	
R190	2007-000071	R-CHIP	22ohm,5%,1/16W,DA,TP,1608	
R191	2007-000071	R-CHIP	22ohm,5%,1/16W,DA,TP,1608	
R192	2007-000070	R-CHIP	0ohm,5%,1/16W,DA,TP,1608	
R193	2007-000070	R-CHIP	0ohm,5%,1/16W,DA,TP,1608	
R194	2007-000070	R-CHIP	0ohm,5%,1/16W,DA,TP,1608	
R195	2007-000070	R-CHIP	0ohm,5%,1/16W,DA,TP,1608	
R2	2007-000070	R-CHIP	0ohm,5%,1/16W,DA,TP,1608	
R20	2007-000072	R-CHIP	47ohm,5%,1/16W,DA,TP,1608	
R2000	2007-000070	R-CHIP	0ohm,5%,1/16W,DA,TP,1608	
R201	2007-000102	R-CHIP	100Kohm,5%,1/16W,DA,TP,1608	
R202	2007-000133	R-CHIP	330Kohm,5%,1/16W,DA,TP,1608	
R203	2007-000102	R-CHIP	100Kohm,5%,1/16W,DA,TP,1608	
R204	2007-000133	R-CHIP	330Kohm,5%,1/16W,DA,TP,1608	
R205	2007-000071	R-CHIP	22ohm,5%,1/16W,DA,TP,1608	
R206	2007-000071	R-CHIP	22ohm,5%,1/16W,DA,TP,1608	
R207	2007-000071	R-CHIP	22ohm,5%,1/16W,DA,TP,1608	
R208	2007-000071	R-CHIP	22ohm,5%,1/16W,DA,TP,1608	
R209	2007-000074	R-CHIP	100ohm,5%,1/16W,DA,TP,1608	
R21	2007-000097	R-CHIP	47Kohm,5%,1/16W,DA,TP,1608	
R210	2007-000074	R-CHIP	100ohm,5%,1/16W,DA,TP,1608	
R211	2007-000090	R-CHIP	10KOHM,5%,1/16W,DA,TP,1608	
R212	2007-000309	R-CHIP	10ohm,5%,1/16W,DA,TP,1608	
R213	2007-000309	R-CHIP	10ohm,5%,1/16W,DA,TP,1608	
R214	2007-000090	R-CHIP	10KOHM,5%,1/16W,DA,TP,1608	
R215	2007-000309	R-CHIP	10ohm,5%,1/16W,DA,TP,1608	
R216	2007-000309	R-CHIP	10ohm,5%,1/16W,DA,TP,1608	
R217	2007-000070	R-CHIP	0ohm,5%,1/16W,DA,TP,1608	
R218	2007-000070	R-CHIP	0ohm,5%,1/16W,DA,TP,1608	
R219	2007-000070	R-CHIP	0ohm,5%,1/16W,DA,TP,1608	
R22	2007-000097	R-CHIP	47Kohm,5%,1/16W,DA,TP,1608	
R220	2007-000309	R-CHIP	10ohm,5%,1/16W,DA,TP,1608	
R221	2007-000309	R-CHIP	10ohm,5%,1/16W,DA,TP,1608	
R222	2007-000309	R-CHIP	10ohm,5%,1/16W,DA,TP,1608	
R223	2007-000309	R-CHIP	10ohm,5%,1/16W,DA,TP,1608	
R224	2007-000074	R-CHIP	100ohm,5%,1/16W,DA,TP,1608	
R225	2007-000074	R-CHIP	100ohm,5%,1/16W,DA,TP,1608	
R226	2007-000082	R-CHIP	3.3Kohm,5%,1/16W,DA,TP,1608	
R227	2007-000078	R-CHIP	1Kohm,5%,1/16W,DA,TP,1608	
R228	2007-001002	R-CHIP	510ohm,5%,1/16W,DA,TP,1608	
R229	2007-000074	R-CHIP	100ohm,5%,1/16W,DA,TP,1608	
R23	2007-000077	R-CHIP	470ohm,5%,1/16W,DA,TP,1608	
R230	2007-000074	R-CHIP	100ohm,5%,1/16W,DA,TP,1608	
R231	2007-000071	R-CHIP	22ohm,5%,1/16W,DA,TP,1608	
R232	2007-000071	R-CHIP	22ohm,5%,1/16W,DA,TP,1608	
R233	2007-000071	R-CHIP	22ohm,5%,1/16W,DA,TP,1608	
R234	2007-000799	R-CHIP	360ohm,5%,1/16W,DA,TP,1608	
R235	2007-001167	R-CHIP	75ohm,5%,1/16W,DA,TP,1608	

Loc. No.	Code No.	Description	Specification	Remarks
R236	2007-001167	R-CHIP	75ohm,5%,1/16W,DA,TP,1608	
R237	2007-001167	R-CHIP	75ohm,5%,1/16W,DA,TP,1608	
R24	2007-000078	R-CHIP	1Kohm,5%,1/16W,DA,TP,1608	
R241	2007-000070	R-CHIP	0ohm,5%,1/16W,DA,TP,1608	
R242	2007-000070	R-CHIP	0ohm,5%,1/16W,DA,TP,1608	
R243	2007-000070	R-CHIP	0ohm,5%,1/16W,DA,TP,1608	
R244	2007-000070	R-CHIP	0ohm,5%,1/16W,DA,TP,1608	
R245	2007-000070	R-CHIP	0ohm,5%,1/16W,DA,TP,1608	
R246	2007-000084	R-CHIP	4.7Kohm,5%,1/16W,DA,TP,1608	
R247	2007-000084	R-CHIP	4.7Kohm,5%,1/16W,DA,TP,1608	
R248	2007-000102	R-CHIP	100Kohm,5%,1/16W,DA,TP,1608	
R249	2007-000133	R-CHIP	330Kohm,5%,1/16W,DA,TP,1608	
R25	2007-000084	R-CHIP	4.7Kohm,5%,1/16W,DA,TP,1608	
R250	2007-000071	R-CHIP	22ohm,5%,1/16W,DA,TP,1608	
R251	2007-000071	R-CHIP	22ohm,5%,1/16W,DA,TP,1608	
R252	2007-000071	R-CHIP	22ohm,5%,1/16W,DA,TP,1608	
R253	2007-000071	R-CHIP	22ohm,5%,1/16W,DA,TP,1608	
R26	2007-000132	R-CHIP	180Kohm,5%,1/16W,DA,TP,1608	
R27	2007-000124	R-CHIP	2.2Kohm,5%,1/16W,DA,TP,1608	
R28	2007-000077	R-CHIP	470ohm,5%,1/16W,DA,TP,1608	
R29	2007-000119	R-CHIP	560ohm,5%,1/16W,DA,TP,1608	
R298	2007-000070	R-CHIP	0ohm,5%,1/16W,DA,TP,1608	
R299	2007-000070	R-CHIP	0ohm,5%,1/16W,DA,TP,1608	
R3	2007-000070	R-CHIP	0ohm,5%,1/16W,DA,TP,1608	
R30	2007-001167	R-CHIP	75ohm,5%,1/16W,DA,TP,1608	
R301	2007-000078	R-CHIP	1Kohm,5%,1/16W,DA,TP,1608	
R303	2007-000078	R-CHIP	1Kohm,5%,1/16W,DA,TP,1608	
R304	2007-000078	R-CHIP	1Kohm,5%,1/16W,DA,TP,1608	
R305	2007-000070	R-CHIP	0ohm,5%,1/16W,DA,TP,1608	
R306	2007-000070	R-CHIP	0ohm,5%,1/16W,DA,TP,1608	
R307	2007-000070	R-CHIP	0ohm,5%,1/16W,DA,TP,1608	
R308	2007-000070	R-CHIP	0ohm,5%,1/16W,DA,TP,1608	
R309	2007-000070	R-CHIP	0ohm,5%,1/16W,DA,TP,1608	
R31	2007-000074	R-CHIP	100ohm,5%,1/16W,DA,TP,1608	
R310	2007-000070	R-CHIP	0ohm,5%,1/16W,DA,TP,1608	
R311	2007-000070	R-CHIP	0ohm,5%,1/16W,DA,TP,1608	
R312	2007-000070	R-CHIP	0ohm,5%,1/16W,DA,TP,1608	
R313	2007-000070	R-CHIP	0ohm,5%,1/16W,DA,TP,1608	
R316	2007-000074	R-CHIP	100ohm,5%,1/16W,DA,TP,1608	
R32	2007-000075	R-CHIP	220ohm,5%,1/16W,DA,TP,1608	
R320	2007-000070	R-CHIP	0ohm,5%,1/16W,DA,TP,1608	
R321	2007-000070	R-CHIP	0ohm,5%,1/16W,DA,TP,1608	
R322	2007-000070	R-CHIP	0ohm,5%,1/16W,DA,TP,1608	
R323	2007-000070	R-CHIP	0ohm,5%,1/16W,DA,TP,1608	
R324	2007-000074	R-CHIP	100ohm,5%,1/16W,DA,TP,1608	
R325	2007-000070	R-CHIP	0ohm,5%,1/16W,DA,TP,1608	
R326	2007-000074	R-CHIP	100ohm,5%,1/16W,DA,TP,1608	
R327	2007-000070	R-CHIP	0ohm,5%,1/16W,DA,TP,1608	
R328	2007-000402	R-CHIP	150ohm,5%,1/16W,DA,TP,1608	
R329	2007-000075	R-CHIP	220ohm,5%,1/16W,DA,TP,1608	
R33	2007-000070	R-CHIP	0ohm,5%,1/16W,DA,TP,1608	
R330	2007-000078	R-CHIP	1Kohm,5%,1/16W,DA,TP,1608	
R331	2007-000070	R-CHIP	0ohm,5%,1/16W,DA,TP,1608	
R332	2007-000074	R-CHIP	100ohm,5%,1/16W,DA,TP,1608	
R333	2007-000070	R-CHIP	0ohm,5%,1/16W,DA,TP,1608	
R334	2007-000074	R-CHIP	100ohm,5%,1/16W,DA,TP,1608	
R335	2007-000074	R-CHIP	100ohm,5%,1/16W,DA,TP,1608	
R336	2007-000070	R-CHIP	0ohm,5%,1/16W,DA,TP,1608	
R337	2007-000070	R-CHIP	0ohm,5%,1/16W,DA,TP,1608	
R338	2007-000070	R-CHIP	0ohm,5%,1/16W,DA,TP,1608	
R339	2007-000070	R-CHIP	0ohm,5%,1/16W,DA,TP,1608	
R34	2007-000309	R-CHIP	10ohm,5%,1/16W,DA,TP,1608	
R340	2007-000074	R-CHIP	100ohm,5%,1/16W,DA,TP,1608	
R342	2007-001167	R-CHIP	75ohm,5%,1/16W,DA,TP,1608	
R343	2007-001167	R-CHIP	75ohm,5%,1/16W,DA,TP,1608	
R344	2007-001167	R-CHIP	75ohm,5%,1/16W,DA,TP,1608	
R345	2007-000070	R-CHIP	0ohm,5%,1/16W,DA,TP,1608	
R346	2007-000070	R-CHIP	0ohm,5%,1/16W,DA,TP,1608	
R347	2007-001167	R-CHIP	75ohm,5%,1/16W,DA,TP,1608	
R35	2007-000402	R-CHIP	150ohm,5%,1/16W,DA,TP,1608	
R352	2007-000402	R-CHIP	150ohm,5%,1/16W,DA,TP,1608	

Loc. No.	Code No.	Description	Specification	Remarks
R353	2007-001167	R-CHIP	75ohm,5%,1/16W,DA,TP,1608	
R354	2007-000084	R-CHIP	4.7Kohm,5%,1/16W,DA,TP,1608	
R355	2007-000113	R-CHIP	33ohm,5%,1/16W,DA,TP,1608	
R356	2007-000113	R-CHIP	33ohm,5%,1/16W,DA,TP,1608	
R357	2007-000113	R-CHIP	33ohm,5%,1/16W,DA,TP,1608	
R358	2007-000070	R-CHIP	0ohm,5%,1/16W,DA,TP,1608	
R359	2007-000070	R-CHIP	0ohm,5%,1/16W,DA,TP,1608	
R36	2007-000077	R-CHIP	470ohm,5%,1/16W,DA,TP,1608	
R361	2007-000107	R-CHIP	470Kohm,5%,1/16W,DA,TP,1608	
R364	2007-000070	R-CHIP	0ohm,5%,1/16W,DA,TP,1608	
R368	2007-000070	R-CHIP	0ohm,5%,1/16W,DA,TP,1608	
R37	2007-000077	R-CHIP	470ohm,5%,1/16W,DA,TP,1608	
R371	2007-000074	R-CHIP	100ohm,5%,1/16W,DA,TP,1608	
R372	2007-000070	R-CHIP	0ohm,5%,1/16W,DA,TP,1608	
R375	2007-000090	R-CHIP	10KOHM,5%,1/16W,DA,TP,1608	
R376	2007-000113	R-CHIP	33ohm,5%,1/16W,DA,TP,1608	
R377	2007-000113	R-CHIP	33ohm,5%,1/16W,DA,TP,1608	
R378	2007-000113	R-CHIP	33ohm,5%,1/16W,DA,TP,1608	
R38	2007-000070	R-CHIP	0ohm,5%,1/16W,DA,TP,1608	
R39	2007-000075	R-CHIP	220ohm,5%,1/16W,DA,TP,1608	
R4	2007-000074	R-CHIP	100ohm,5%,1/16W,DA,TP,1608	
R40	2007-000075	R-CHIP	220ohm,5%,1/16W,DA,TP,1608	
R401	2007-000102	R-CHIP	100Kohm,5%,1/16W,DA,TP,1608	
R402	2007-000133	R-CHIP	330Kohm,5%,1/16W,DA,TP,1608	
R403	2007-000102	R-CHIP	100Kohm,5%,1/16W,DA,TP,1608	
R404	2007-000133	R-CHIP	330Kohm,5%,1/16W,DA,TP,1608	
R405	2007-000070	R-CHIP	0ohm,5%,1/16W,DA,TP,1608	
R406	2007-000070	R-CHIP	0ohm,5%,1/16W,DA,TP,1608	
R407	2007-000070	R-CHIP	0ohm,5%,1/16W,DA,TP,1608	
R408	2007-000113	R-CHIP	33ohm,5%,1/16W,DA,TP,1608	
R409	2007-000113	R-CHIP	33ohm,5%,1/16W,DA,TP,1608	
R41	2007-000086	R-CHIP	5.6Kohm,5%,1/16W,DA,TP,1608	
R410	2007-000113	R-CHIP	33ohm,5%,1/16W,DA,TP,1608	
R411	2007-000070	R-CHIP	0ohm,5%,1/16W,DA,TP,1608	
R412	2007-001167	R-CHIP	75ohm,5%,1/16W,DA,TP,1608	
R413	2007-001167	R-CHIP	75ohm,5%,1/16W,DA,TP,1608	
R414	2007-001167	R-CHIP	75ohm,5%,1/16W,DA,TP,1608	
R415	2007-000090	R-CHIP	10KOHM,5%,1/16W,DA,TP,1608	
R416	2007-000107	R-CHIP	470Kohm,5%,1/16W,DA,TP,1608	
R417	2007-000074	R-CHIP	100ohm,5%,1/16W,DA,TP,1608	
R418	2007-000070	R-CHIP	0ohm,5%,1/16W,DA,TP,1608	
R419	2007-000074	R-CHIP	100ohm,5%,1/16W,DA,TP,1608	
R42	2007-000070	R-CHIP	0ohm,5%,1/16W,DA,TP,1608	
R420	2007-000070	R-CHIP	0ohm,5%,1/16W,DA,TP,1608	
R421	2007-000074	R-CHIP	100ohm,5%,1/16W,DA,TP,1608	
R422	2007-000070	R-CHIP	0ohm,5%,1/16W,DA,TP,1608	
R423	2007-000090	R-CHIP	10KOHM,5%,1/16W,DA,TP,1608	
R424	2007-000070	R-CHIP	0ohm,5%,1/16W,DA,TP,1608	
R425	2007-000070	R-CHIP	0ohm,5%,1/16W,DA,TP,1608	
R426	2007-000070	R-CHIP	0ohm,5%,1/16W,DA,TP,1608	
R427	2007-000113	R-CHIP	33ohm,5%,1/16W,DA,TP,1608	
R428	2007-000113	R-CHIP	33ohm,5%,1/16W,DA,TP,1608	
R429	2007-000113	R-CHIP	33ohm,5%,1/16W,DA,TP,1608	
R43	2007-000070	R-CHIP	0ohm,5%,1/16W,DA,TP,1608	
R430	2007-001167	R-CHIP	75ohm,5%,1/16W,DA,TP,1608	
R431	2007-001167	R-CHIP	75ohm,5%,1/16W,DA,TP,1608	
R432	2007-001167	R-CHIP	75ohm,5%,1/16W,DA,TP,1608	
R433	2007-000082	R-CHIP	3.3Kohm,5%,1/16W,DA,TP,1608	
R44	2007-000077	R-CHIP	470ohm,5%,1/16W,DA,TP,1608	
R45	2007-000078	R-CHIP	1Kohm,5%,1/16W,DA,TP,1608	
R46	2007-000070	R-CHIP	0ohm,5%,1/16W,DA,TP,1608	
R462	2007-000070	R-CHIP	0ohm,5%,1/16W,DA,TP,1608	
R47	2007-000072	R-CHIP	47ohm,5%,1/16W,DA,TP,1608	
R48	2007-000077	R-CHIP	470ohm,5%,1/16W,DA,TP,1608	
R49	2007-000078	R-CHIP	1Kohm,5%,1/16W,DA,TP,1608	
R5	2007-000070	R-CHIP	0ohm,5%,1/16W,DA,TP,1608	
R50	2007-000084	R-CHIP	4.7Kohm,5%,1/16W,DA,TP,1608	
R501	2007-000074	R-CHIP	100ohm,5%,1/16W,DA,TP,1608	
R502	2007-000074	R-CHIP	100ohm,5%,1/16W,DA,TP,1608	
R503	2007-000074	R-CHIP	100ohm,5%,1/16W,DA,TP,1608	

Loc. No.	Code No.	Description	Specification	Remarks
R504	2007-000074	R-CHIP	100ohm,5%,1/16W,DA,TP,1608	
R505	2007-000074	R-CHIP	100ohm,5%,1/16W,DA,TP,1608	
R506	2007-000074	R-CHIP	100ohm,5%,1/16W,DA,TP,1608	
R507	2007-000074	R-CHIP	100ohm,5%,1/16W,DA,TP,1608	
R508	2007-000074	R-CHIP	100ohm,5%,1/16W,DA,TP,1608	
R509	2007-000074	R-CHIP	100ohm,5%,1/16W,DA,TP,1608	
R51	2007-000119	R-CHIP	560ohm,5%,1/16W,DA,TP,1608	
R510	2007-000074	R-CHIP	100ohm,5%,1/16W,DA,TP,1608	
R511	2007-000309	R-CHIP	10ohm,5%,1/16W,DA,TP,1608	
R512	2007-000086	R-CHIP	5.6Kohm,5%,1/16W,DA,TP,1608	
R513	2007-000081	R-CHIP	2.7Kohm,5%,1/16W,DA,TP,1608	
R514	2007-000076	R-CHIP	330ohm,5%,1/16W,DA,TP,1608	
R515	2007-000084	R-CHIP	4.7Kohm,5%,1/16W,DA,TP,1608	
R516	2007-000093	R-CHIP	20Kohm,5%,1/16W,DA,TP,1608	
R517	2007-000074	R-CHIP	100ohm,5%,1/16W,DA,TP,1608	
R518	2007-000093	R-CHIP	20Kohm,5%,1/16W,DA,TP,1608	
R519	2007-000076	R-CHIP	330ohm,5%,1/16W,DA,TP,1608	
R52	2007-001167	R-CHIP	75ohm,5%,1/16W,DA,TP,1608	
R520	2007-000109	R-CHIP	1Mohm,5%,1/16W,DA,TP,1608	
R521	2007-000084	R-CHIP	4.7Kohm,5%,1/16W,DA,TP,1608	
R522	2007-000076	R-CHIP	330ohm,5%,1/16W,DA,TP,1608	
R523	2007-000309	R-CHIP	10ohm,5%,1/16W,DA,TP,1608	
R524	2007-000078	R-CHIP	1Kohm,5%,1/16W,DA,TP,1608	
R525	2007-000074	R-CHIP	100ohm,5%,1/16W,DA,TP,1608	
R526	2007-000074	R-CHIP	100ohm,5%,1/16W,DA,TP,1608	
R527	2007-000074	R-CHIP	100ohm,5%,1/16W,DA,TP,1608	
R528	2007-000084	R-CHIP	4.7Kohm,5%,1/16W,DA,TP,1608	
R529	2007-000074	R-CHIP	100ohm,5%,1/16W,DA,TP,1608	
R53	2007-000309	R-CHIP	10ohm,5%,1/16W,DA,TP,1608	
R530	2007-000074	R-CHIP	100ohm,5%,1/16W,DA,TP,1608	
R531	2007-000084	R-CHIP	4.7Kohm,5%,1/16W,DA,TP,1608	
R532	2007-000090	R-CHIP	10KOHM,5%,1/16W,DA,TP,1608	
R533	2007-000309	R-CHIP	10ohm,5%,1/16W,DA,TP,1608	
R534	2007-000084	R-CHIP	4.7Kohm,5%,1/16W,DA,TP,1608	
R535	2007-000084	R-CHIP	4.7Kohm,5%,1/16W,DA,TP,1608	
R536	2007-000309	R-CHIP	10ohm,5%,1/16W,DA,TP,1608	
R537	2007-000078	R-CHIP	1Kohm,5%,1/16W,DA,TP,1608	
R538	2007-000078	R-CHIP	1Kohm,5%,1/16W,DA,TP,1608	
R539	2007-000090	R-CHIP	10KOHM,5%,1/16W,DA,TP,1608	
R54	2007-000077	R-CHIP	470ohm,5%,1/16W,DA,TP,1608	
R540	2007-000090	R-CHIP	10KOHM,5%,1/16W,DA,TP,1608	
R541	2007-000090	R-CHIP	10KOHM,5%,1/16W,DA,TP,1608	
R542	2007-000090	R-CHIP	10KOHM,5%,1/16W,DA,TP,1608	
R543	2007-000078	R-CHIP	1Kohm,5%,1/16W,DA,TP,1608	
R544	2007-000078	R-CHIP	1Kohm,5%,1/16W,DA,TP,1608	
R545	2007-000078	R-CHIP	1Kohm,5%,1/16W,DA,TP,1608	
R546	2007-000078	R-CHIP	1Kohm,5%,1/16W,DA,TP,1608	
R547	2007-000078	R-CHIP	1Kohm,5%,1/16W,DA,TP,1608	
R548	2007-000078	R-CHIP	1Kohm,5%,1/16W,DA,TP,1608	
R55	2007-000077	R-CHIP	470ohm,5%,1/16W,DA,TP,1608	
R56	2007-000075	R-CHIP	220ohm,5%,1/16W,DA,TP,1608	
R57	2007-000086	R-CHIP	5.6Kohm,5%,1/16W,DA,TP,1608	
R58	2007-000070	R-CHIP	0ohm,5%,1/16W,DA,TP,1608	
R59	2007-000070	R-CHIP	0ohm,5%,1/16W,DA,TP,1608	
R6	2007-000070	R-CHIP	0ohm,5%,1/16W,DA,TP,1608	
R60	2007-000070	R-CHIP	0ohm,5%,1/16W,DA,TP,1608	
R601	2007-000090	R-CHIP	10KOHM,5%,1/16W,DA,TP,1608	
R602	2007-000071	R-CHIP	22ohm,5%,1/16W,DA,TP,1608	
R603	2007-000090	R-CHIP	10KOHM,5%,1/16W,DA,TP,1608	
R604	2007-000084	R-CHIP	4.7Kohm,5%,1/16W,DA,TP,1608	
R605	2007-000090	R-CHIP	10KOHM,5%,1/16W,DA,TP,1608	
R606	2007-000071	R-CHIP	22ohm,5%,1/16W,DA,TP,1608	
R607	2007-000090	R-CHIP	10KOHM,5%,1/16W,DA,TP,1608	
R608	2007-000090	R-CHIP	10KOHM,5%,1/16W,DA,TP,1608	
R609	2007-000070	R-CHIP	0ohm,5%,1/16W,DA,TP,1608	
R61	2007-000070	R-CHIP	0ohm,5%,1/16W,DA,TP,1608	
R610	2007-000070	R-CHIP	0ohm,5%,1/16W,DA,TP,1608	
R611	2007-000070	R-CHIP	0ohm,5%,1/16W,DA,TP,1608	
R612	2007-000070	R-CHIP	0ohm,5%,1/16W,DA,TP,1608	
R613	2007-000071	R-CHIP	22ohm,5%,1/16W,DA,TP,1608	

Loc. No.	Code No.	Description	Specification	Remarks
R614	2007-000071	R-CHIP	22ohm,5%,1/16W,DA,TP,1608	
R615	2007-000071	R-CHIP	22ohm,5%,1/16W,DA,TP,1608	
R616	2007-000071	R-CHIP	22ohm,5%,1/16W,DA,TP,1608	
R617	2007-000071	R-CHIP	22ohm,5%,1/16W,DA,TP,1608	
R618	2007-000070	R-CHIP	0ohm,5%,1/16W,DA,TP,1608	
R619	2007-000070	R-CHIP	0ohm,5%,1/16W,DA,TP,1608	
R62	2007-000070	R-CHIP	0ohm,5%,1/16W,DA,TP,1608	
R620	2007-000070	R-CHIP	0ohm,5%,1/16W,DA,TP,1608	
R621	2007-000070	R-CHIP	0ohm,5%,1/16W,DA,TP,1608	
R622	2007-000074	R-CHIP	100ohm,5%,1/16W,DA,TP,1608	
R623	2007-000074	R-CHIP	100ohm,5%,1/16W,DA,TP,1608	
R624	2007-000074	R-CHIP	100ohm,5%,1/16W,DA,TP,1608	
R625	2007-000071	R-CHIP	22ohm,5%,1/16W,DA,TP,1608	
R626	2007-000074	R-CHIP	100ohm,5%,1/16W,DA,TP,1608	
R627	2007-000071	R-CHIP	22ohm,5%,1/16W,DA,TP,1608	
R628	2007-000074	R-CHIP	100ohm,5%,1/16W,DA,TP,1608	
R629	2007-000071	R-CHIP	22ohm,5%,1/16W,DA,TP,1608	
R63	2007-000074	R-CHIP	100ohm,5%,1/16W,DA,TP,1608	
R630	2007-000071	R-CHIP	22ohm,5%,1/16W,DA,TP,1608	
R631	2007-000074	R-CHIP	100ohm,5%,1/16W,DA,TP,1608	
R632	2007-000071	R-CHIP	22ohm,5%,1/16W,DA,TP,1608	
R633	2007-000071	R-CHIP	22ohm,5%,1/16W,DA,TP,1608	
R634	2007-000074	R-CHIP	100ohm,5%,1/16W,DA,TP,1608	
R635	2007-000071	R-CHIP	22ohm,5%,1/16W,DA,TP,1608	
R636	2007-000071	R-CHIP	22ohm,5%,1/16W,DA,TP,1608	
R637	2007-000071	R-CHIP	22ohm,5%,1/16W,DA,TP,1608	
R638	2007-000070	R-CHIP	0ohm,5%,1/16W,DA,TP,1608	
R639	2007-000070	R-CHIP	0ohm,5%,1/16W,DA,TP,1608	
R64	2007-000070	R-CHIP	0ohm,5%,1/16W,DA,TP,1608	
R640	2007-000070	R-CHIP	0ohm,5%,1/16W,DA,TP,1608	
R641	2007-000070	R-CHIP	0ohm,5%,1/16W,DA,TP,1608	
R642	2007-000070	R-CHIP	0ohm,5%,1/16W,DA,TP,1608	
R643	2007-000070	R-CHIP	0ohm,5%,1/16W,DA,TP,1608	
R644	2007-000070	R-CHIP	0ohm,5%,1/16W,DA,TP,1608	
R645	2007-000070	R-CHIP	0ohm,5%,1/16W,DA,TP,1608	
R646	2007-000071	R-CHIP	22ohm,5%,1/16W,DA,TP,1608	
R647	2007-000071	R-CHIP	22ohm,5%,1/16W,DA,TP,1608	
R648	2007-000071	R-CHIP	22ohm,5%,1/16W,DA,TP,1608	
R649	2007-000071	R-CHIP	22ohm,5%,1/16W,DA,TP,1608	
R65	2007-000070	R-CHIP	0ohm,5%,1/16W,DA,TP,1608	
R650	2007-000071	R-CHIP	22ohm,5%,1/16W,DA,TP,1608	
R651	2007-000071	R-CHIP	22ohm,5%,1/16W,DA,TP,1608	
R652	2007-000074	R-CHIP	100ohm,5%,1/16W,DA,TP,1608	
R653	2007-000074	R-CHIP	100ohm,5%,1/16W,DA,TP,1608	
R654	2007-000084	R-CHIP	4.7Kohm,5%,1/16W,DA,TP,1608	
R655	2007-000071	R-CHIP	22ohm,5%,1/16W,DA,TP,1608	
R656	2007-000071	R-CHIP	22ohm,5%,1/16W,DA,TP,1608	
R659	2007-000071	R-CHIP	22ohm,5%,1/16W,DA,TP,1608	
R66	2007-000070	R-CHIP	0ohm,5%,1/16W,DA,TP,1608	
R660	2007-000074	R-CHIP	100ohm,5%,1/16W,DA,TP,1608	
R67	2007-000070	R-CHIP	0ohm,5%,1/16W,DA,TP,1608	
R68	2007-000134	R-CHIP	33Kohm,5%,1/16W,DA,TP,1608	
R69	2007-000079	R-CHIP	1.8Kohm,5%,1/16W,DA,TP,1608	
R7	2007-000074	R-CHIP	100ohm,5%,1/16W,DA,TP,1608	
R70	2007-000070	R-CHIP	0ohm,5%,1/16W,DA,TP,1608	
R701	2007-000070	R-CHIP	0ohm,5%,1/16W,DA,TP,1608	
R702	2007-000113	R-CHIP	33ohm,5%,1/16W,DA,TP,1608	
R703	2007-000076	R-CHIP	330ohm,5%,1/16W,DA,TP,1608	
R704	2007-000074	R-CHIP	100ohm,5%,1/16W,DA,TP,1608	
R705	2007-000074	R-CHIP	100ohm,5%,1/16W,DA,TP,1608	
R706	2007-000305	R-CHIP	10Mohm,5%,1/16W,DA,TP,1608	
R707	2007-000070	R-CHIP	0ohm,5%,1/16W,DA,TP,1608	
R708	2007-000070	R-CHIP	0ohm,5%,1/16W,DA,TP,1608	
R71	2007-000070	R-CHIP	0ohm,5%,1/16W,DA,TP,1608	
R712	2007-000070	R-CHIP	0ohm,5%,1/16W,DA,TP,1608	
R713	2007-000076	R-CHIP	330ohm,5%,1/16W,DA,TP,1608	
R714	2007-000076	R-CHIP	330ohm,5%,1/16W,DA,TP,1608	
R715	2007-000076	R-CHIP	330ohm,5%,1/16W,DA,TP,1608	
R716	2007-000076	R-CHIP	330ohm,5%,1/16W,DA,TP,1608	
R717	2007-000070	R-CHIP	0ohm,5%,1/16W,DA,TP,1608	



Loc. No.	Code No.	Description	Specification	Remarks
R718	2007-000070	R-CHIP	0ohm,5%,1/16W,DA,TP,1608	
R72	2007-000119	R-CHIP	560ohm,5%,1/16W,DA,TP,1608	
R720	2007-000070	R-CHIP	0ohm,5%,1/16W,DA,TP,1608	
R721	2007-000070	R-CHIP	0ohm,5%,1/16W,DA,TP,1608	
R722	2007-000071	R-CHIP	22ohm,5%,1/16W,DA,TP,1608	
R723	2007-000074	R-CHIP	100ohm,5%,1/16W,DA,TP,1608	
R724	2007-000074	R-CHIP	100ohm,5%,1/16W,DA,TP,1608	
R73	2007-000072	R-CHIP	47ohm,5%,1/16W,DA,TP,1608	
R74	2007-000071	R-CHIP	22ohm,5%,1/16W,DA,TP,1608	
R75	2007-000070	R-CHIP	0ohm,5%,1/16W,DA,TP,1608	
R76	2007-000086	R-CHIP	5.6Kohm,5%,1/16W,DA,TP,1608	
R77	2007-000090	R-CHIP	10KOHM,5%,1/16W,DA,TP,1608	
R78	2007-000077	R-CHIP	470ohm,5%,1/16W,DA,TP,1608	
R79	2007-000077	R-CHIP	470ohm,5%,1/16W,DA,TP,1608	
R8	2007-000070	R-CHIP	0ohm,5%,1/16W,DA,TP,1608	
R80	2007-000070	R-CHIP	0ohm,5%,1/16W,DA,TP,1608	
R801	2007-000090	R-CHIP	10KOHM,5%,1/16W,DA,TP,1608	
R802	2007-000090	R-CHIP	10KOHM,5%,1/16W,DA,TP,1608	
R803	2007-000084	R-CHIP	4.7Kohm,5%,1/16W,DA,TP,1608	
R804	2007-000090	R-CHIP	10KOHM,5%,1/16W,DA,TP,1608	
R805	2007-000071	R-CHIP	22ohm,5%,1/16W,DA,TP,1608	
R806	2007-000090	R-CHIP	10KOHM,5%,1/16W,DA,TP,1608	
R807	2007-000090	R-CHIP	10KOHM,5%,1/16W,DA,TP,1608	
R808	2007-000070	R-CHIP	0ohm,5%,1/16W,DA,TP,1608	
R809	2007-000070	R-CHIP	0ohm,5%,1/16W,DA,TP,1608	
R81	2007-001167	R-CHIP	75ohm,5%,1/16W,DA,TP,1608	
R810	2007-000070	R-CHIP	0ohm,5%,1/16W,DA,TP,1608	
R811	2007-000070	R-CHIP	0ohm,5%,1/16W,DA,TP,1608	
R812	2007-000071	R-CHIP	22ohm,5%,1/16W,DA,TP,1608	
R813	2007-000071	R-CHIP	22ohm,5%,1/16W,DA,TP,1608	
R814	2007-000071	R-CHIP	22ohm,5%,1/16W,DA,TP,1608	
R815	2007-000071	R-CHIP	22ohm,5%,1/16W,DA,TP,1608	
R816	2007-000071	R-CHIP	22ohm,5%,1/16W,DA,TP,1608	
R817	2007-000071	R-CHIP	22ohm,5%,1/16W,DA,TP,1608	
R818	2007-000071	R-CHIP	22ohm,5%,1/16W,DA,TP,1608	
R819	2007-000070	R-CHIP	0ohm,5%,1/16W,DA,TP,1608	
R82	2007-001167	R-CHIP	75ohm,5%,1/16W,DA,TP,1608	
R820	2007-000071	R-CHIP	22ohm,5%,1/16W,DA,TP,1608	
R821	2007-000071	R-CHIP	22ohm,5%,1/16W,DA,TP,1608	
R822	2007-000071	R-CHIP	22ohm,5%,1/16W,DA,TP,1608	
R823	2007-000071	R-CHIP	22ohm,5%,1/16W,DA,TP,1608	
R824	2007-000071	R-CHIP	22ohm,5%,1/16W,DA,TP,1608	
R825	2007-000071	R-CHIP	22ohm,5%,1/16W,DA,TP,1608	
R826	2007-000070	R-CHIP	0ohm,5%,1/16W,DA,TP,1608	
R827	2007-000071	R-CHIP	22ohm,5%,1/16W,DA,TP,1608	
R828	2007-000070	R-CHIP	0ohm,5%,1/16W,DA,TP,1608	
R829	2007-000084	R-CHIP	4.7Kohm,5%,1/16W,DA,TP,1608	
R83	2007-000070	R-CHIP	0ohm,5%,1/16W,DA,TP,1608	
R830	2007-000071	R-CHIP	22ohm,5%,1/16W,DA,TP,1608	
R832	2007-000071	R-CHIP	22ohm,5%,1/16W,DA,TP,1608	
R834	2007-000071	R-CHIP	22ohm,5%,1/16W,DA,TP,1608	
R84	2007-000070	R-CHIP	0ohm,5%,1/16W,DA,TP,1608	
R9	2007-000070	R-CHIP	0ohm,5%,1/16W,DA,TP,1608	
R932	2007-000084	R-CHIP	4.7Kohm,5%,1/16W,DA,TP,1608	
R934	2007-000122	R-CHIP	1.2Kohm,5%,1/16W,DA,TP,1608	
R936	2007-000102	R-CHIP	100Kohm,5%,1/16W,DA,TP,1608	
R937	2007-000093	R-CHIP	20Kohm,5%,1/16W,DA,TP,1608	
R938	2007-007730	R-CHIP	6.8MOHM,1%,1/10W,DA,TP,1608	
R939	2007-000052	R-CHIP	10Kohm,1%,1/16W,DA,TP,1608	
R940	2007-002902	R-CHIP	162Kohm,1%,1/16W,DA,TP,1608	
R941	2007-007730	R-CHIP	6.8MOHM,1%,1/10W,DA,TP,1608	
R942	2007-000070	R-CHIP	0ohm,5%,1/16W,DA,TP,1608	
R950	2007-000077	R-CHIP	470ohm,5%,1/16W,DA,TP,1608	
R951	2007-000084	R-CHIP	4.7Kohm,5%,1/16W,DA,TP,1608	
R952	2007-000084	R-CHIP	4.7Kohm,5%,1/16W,DA,TP,1608	
R953	2007-000077	R-CHIP	470ohm,5%,1/16W,DA,TP,1608	
R954	2007-000084	R-CHIP	4.7Kohm,5%,1/16W,DA,TP,1608	
R955	2007-000074	R-CHIP	100ohm,5%,1/16W,DA,TP,1608	
R956	2007-000090	R-CHIP	10KOHM,5%,1/16W,DA,TP,1608	
R957	2007-000084	R-CHIP	4.7Kohm,5%,1/16W,DA,TP,1608	

Loc. No.	Code No.	Description	Specification	Remarks
R958	2007-000084	R-CHIP	4.7Kohm,5%,1/16W,DA,TP,1608	
R959	2007-000084	R-CHIP	4.7Kohm,5%,1/16W,DA,TP,1608	
R960	2007-000084	R-CHIP	4.7Kohm,5%,1/16W,DA,TP,1608	
R961	2007-000074	R-CHIP	100ohm,5%,1/16W,DA,TP,1608	
R962	2007-000090	R-CHIP	10KOHM,5%,1/16W,DA,TP,1608	
R963	2007-000084	R-CHIP	4.7Kohm,5%,1/16W,DA,TP,1608	
R964	2007-000084	R-CHIP	4.7Kohm,5%,1/16W,DA,TP,1608	
R965	2007-000084	R-CHIP	4.7Kohm,5%,1/16W,DA,TP,1608	
R966	2007-000084	R-CHIP	4.7Kohm,5%,1/16W,DA,TP,1608	
R967	2007-000074	R-CHIP	100ohm,5%,1/16W,DA,TP,1608	
R968	2007-000090	R-CHIP	10KOHM,5%,1/16W,DA,TP,1608	
R969	2007-000077	R-CHIP	470ohm,5%,1/16W,DA,TP,1608	
R970	2007-000084	R-CHIP	4.7Kohm,5%,1/16W,DA,TP,1608	
R971	2007-000077	R-CHIP	470ohm,5%,1/16W,DA,TP,1608	
R972	2007-000084	R-CHIP	4.7Kohm,5%,1/16W,DA,TP,1608	
R973	2007-000074	R-CHIP	100ohm,5%,1/16W,DA,TP,1608	
R974	2007-000090	R-CHIP	10KOHM,5%,1/16W,DA,TP,1608	
R975	2007-000102	R-CHIP	100Kohm,5%,1/16W,DA,TP,1608	
R976	2007-000077	R-CHIP	470ohm,5%,1/16W,DA,TP,1608	
R977	2007-000084	R-CHIP	4.7Kohm,5%,1/16W,DA,TP,1608	
R978	2007-000090	R-CHIP	10KOHM,5%,1/16W,DA,TP,1608	
R979	2007-000102	R-CHIP	100Kohm,5%,1/16W,DA,TP,1608	
R980	2007-000077	R-CHIP	470ohm,5%,1/16W,DA,TP,1608	
R981	2007-000084	R-CHIP	4.7Kohm,5%,1/16W,DA,TP,1608	
R982	2007-000074	R-CHIP	100ohm,5%,1/16W,DA,TP,1608	
R983	2007-000102	R-CHIP	100Kohm,5%,1/16W,DA,TP,1608	
R984	2007-000090	R-CHIP	10KOHM,5%,1/16W,DA,TP,1608	
R985	2007-000090	R-CHIP	10KOHM,5%,1/16W,DA,TP,1608	
R986	2007-000102	R-CHIP	100Kohm,5%,1/16W,DA,TP,1608	
R987	2007-000070	R-CHIP	0ohm,5%,1/16W,DA,TP,1608	
R988	2007-000070	R-CHIP	0ohm,5%,1/16W,DA,TP,1608	
R989	2007-000070	R-CHIP	0ohm,5%,1/16W,DA,TP,1608	
R99	2007-000070	R-CHIP	0ohm,5%,1/16W,DA,TP,1608	
R990	2007-000070	R-CHIP	0ohm,5%,1/16W,DA,TP,1608	
RA201	2011-000002	R-NETWORK	22ohm,5%,63mW,L,CHIP,8P,TP	
RA202	2011-000002	R-NETWORK	22ohm,5%,63mW,L,CHIP,8P,TP	
RA203	2011-000002	R-NETWORK	22ohm,5%,63mW,L,CHIP,8P,TP	
RA204	2011-000002	R-NETWORK	22ohm,5%,63mW,L,CHIP,8P,TP	
RA205	2011-000002	R-NETWORK	22ohm,5%,63mW,L,CHIP,8P,TP	
RA206	2011-000002	R-NETWORK	22ohm,5%,63mW,L,CHIP,8P,TP	
RA207	2011-000002	R-NETWORK	22ohm,5%,63mW,L,CHIP,8P,TP	
RA208	2011-000002	R-NETWORK	22ohm,5%,63mW,L,CHIP,8P,TP	
RA209	2011-000002	R-NETWORK	22ohm,5%,63mW,L,CHIP,8P,TP	
RA210	2011-000002	R-NETWORK	22ohm,5%,63mW,L,CHIP,8P,TP	
RA211	2011-000002	R-NETWORK	22ohm,5%,63mW,L,CHIP,8P,TP	
RA212	2011-000002	R-NETWORK	22ohm,5%,63mW,L,CHIP,8P,TP	
RA301	2011-000002	R-NETWORK	22ohm,5%,63mW,L,CHIP,8P,TP	
RA302	2011-000002	R-NETWORK	22ohm,5%,63mW,L,CHIP,8P,TP	
RA303	2011-000002	R-NETWORK	22ohm,5%,63mW,L,CHIP,8P,TP	
RA304	2011-000002	R-NETWORK	22ohm,5%,63mW,L,CHIP,8P,TP	
RA305	2011-000002	R-NETWORK	22ohm,5%,63mW,L,CHIP,8P,TP	
RA306	2011-000002	R-NETWORK	22ohm,5%,63mW,L,CHIP,8P,TP	
RA307	2011-000002	R-NETWORK	22ohm,5%,63mW,L,CHIP,8P,TP	
RA401	2011-000002	R-NETWORK	22ohm,5%,63mW,L,CHIP,8P,TP	
RA402	2011-000002	R-NETWORK	22ohm,5%,63mW,L,CHIP,8P,TP	
RA403	2011-000002	R-NETWORK	22ohm,5%,63mW,L,CHIP,8P,TP	
RA404	2011-000002	R-NETWORK	22ohm,5%,63mW,L,CHIP,8P,TP	
RA405	2011-000002	R-NETWORK	22ohm,5%,63mW,L,CHIP,8P,TP	
RA406	2011-000002	R-NETWORK	22ohm,5%,63mW,L,CHIP,8P,TP	
RA601	2011-000002	R-NETWORK	22ohm,5%,63mW,L,CHIP,8P,TP	
RA602	2011-000002	R-NETWORK	22ohm,5%,63mW,L,CHIP,8P,TP	
RA603	2011-000002	R-NETWORK	22ohm,5%,63mW,L,CHIP,8P,TP	
RA604	2011-000002	R-NETWORK	22ohm,5%,63mW,L,CHIP,8P,TP	
RA605	2011-000002	R-NETWORK	22ohm,5%,63mW,L,CHIP,8P,TP	
RA701	2011-000002	R-NETWORK	22ohm,5%,63mW,L,CHIP,8P,TP	
RA702	2011-000002	R-NETWORK	22ohm,5%,63mW,L,CHIP,8P,TP	
RA703	2011-000002	R-NETWORK	22ohm,5%,63mW,L,CHIP,8P,TP	
RA704	2011-000002	R-NETWORK	22ohm,5%,63mW,L,CHIP,8P,TP	
RA705	2011-000002	R-NETWORK	22ohm,5%,63mW,L,CHIP,8P,TP	
RA706	2011-000002	R-NETWORK	22ohm,5%,63mW,L,CHIP,8P,TP	

Loc. No.	Code No.	Description	Specification	Remarks
RA707	2011-000002	R-NETWORK	22ohm,5%,63mW,L,CHIP,8P,TP	
RA708	2011-000002	R-NETWORK	22ohm,5%,63mW,L,CHIP,8P,TP	
RA709	2011-000002	R-NETWORK	22ohm,5%,63mW,L,CHIP,8P,TP	
RA710	2011-000002	R-NETWORK	22ohm,5%,63mW,L,CHIP,8P,TP	
RA711	2011-000002	R-NETWORK	22ohm,5%,63mW,L,CHIP,8P,TP	
RA801	2011-000002	R-NETWORK	22ohm,5%,63mW,L,CHIP,8P,TP	
RA802	2011-000002	R-NETWORK	22ohm,5%,63mW,L,CHIP,8P,TP	
RA803	2011-000002	R-NETWORK	22ohm,5%,63mW,L,CHIP,8P,TP	
RA804	2011-000002	R-NETWORK	22ohm,5%,63mW,L,CHIP,8P,TP	
RA805	2011-000002	R-NETWORK	22ohm,5%,63mW,L,CHIP,8P,TP	
RA806	2011-000002	R-NETWORK	22ohm,5%,63mW,L,CHIP,8P,TP	
RA807	2011-000002	R-NETWORK	22ohm,5%,63mW,L,CHIP,8P,TP	
RA808	2011-000002	R-NETWORK	22ohm,5%,63mW,L,CHIP,8P,TP	
RA809	2011-000002	R-NETWORK	22ohm,5%,63mW,L,CHIP,8P,TP	
RA810	2011-000002	R-NETWORK	22ohm,5%,63mW,L,CHIP,8P,TP	
RA811	2011-000002	R-NETWORK	22ohm,5%,63mW,L,CHIP,8P,TP	
RA812	2011-000002	R-NETWORK	22ohm,5%,63mW,L,CHIP,8P,TP	
RA813	2011-000002	R-NETWORK	22ohm,5%,63mW,L,CHIP,8P,TP	
RA814	2011-000002	R-NETWORK	22ohm,5%,63mW,L,CHIP,8P,TP	
RA815	2011-000002	R-NETWORK	22ohm,5%,63mW,L,CHIP,8P,TP	
RA816	2011-000002	R-NETWORK	22ohm,5%,63mW,L,CHIP,8P,TP	
RA817	2011-000002	R-NETWORK	22ohm,5%,63mW,L,CHIP,8P,TP	
X1	2801-003755	CRYSTAL-SMD	20MHZ,30PPM,28-AAN,20PF,500HM,TP	
X1001	2801-001473	CRYSTAL-SMD	4MHz,50ppm,28-AAN,18pF,150ohm,	
X101	2801-003667	CRYSTAL-SMD	14.3182MHZ,50PPM,28-AAN,16,500HM,TP	
X301	2801-004004	CRYSTAL-SMD	20.25MHz,20ppm,28-AAN,13pF,25ohm,TP	
X501	2801-003843	CRYSTAL-SMD	18.432MHz,30ppm,28-AAN,20pf,50ohm,TP	
X701	2804-001521	OSCILLATOR-CLOCK	27MHZ,50PPM,HCMOS,TP,3.3V,25MA	
ZD1	0403-000579	DIODE-ZENER	BZX84C5V1,5.1V,5%,200mW,SOT-23	
ZD1001	0402-000553	DIODE-RECTIFIER	SS24,40V,2.0A,DO-214AA	
ZD2	0403-000579	DIODE-ZENER	BZX84C5V1,5.1V,5%,200mW,SOT-23	
ZD201	0403-000579	DIODE-ZENER	BZX84C5V1,5.1V,5%,200mW,SOT-23	
ZD202	0403-000579	DIODE-ZENER	BZX84C5V1,5.1V,5%,200mW,SOT-23	
ZD203	0403-000579	DIODE-ZENER	BZX84C5V1,5.1V,5%,200mW,SOT-23	
ZD204	0403-000579	DIODE-ZENER	BZX84C5V1,5.1V,5%,200mW,SOT-23	
ZD205	0403-000579	DIODE-ZENER	BZX84C5V1,5.1V,5%,200mW,SOT-23	
ZD501	0403-000579	DIODE-ZENER	BZX84C5V1,5.1V,5%,200mW,SOT-23	
ZD502	0403-001052	DIODE-ZENER	RD8.2MB,8.2V,7.7-8.64V,200mW,S	
ZD503	0403-001052	DIODE-ZENER	RD8.2MB,8.2V,7.7-8.64V,200mW,S	
ZD504	0403-001052	DIODE-ZENER	RD8.2MB,8.2V,7.7-8.64V,200mW,S	
ZD505	0403-000579	DIODE-ZENER	BZX84C5V1,5.1V,5%,200mW,SOT-23	
ZD506	0403-001052	DIODE-ZENER	RD8.2MB,8.2V,7.7-8.64V,200mW,S	
ZD507	0403-001052	DIODE-ZENER	RD8.2MB,8.2V,7.7-8.64V,200mW,S	
ZD510	0403-000579	DIODE-ZENER	BZX84C5V1,5.1V,5%,200mW,SOT-23	
ZD511	0403-000579	DIODE-ZENER	BZX84C5V1,5.1V,5%,200mW,SOT-23	
ZD512	0403-000579	DIODE-ZENER	BZX84C5V1,5.1V,5%,200mW,SOT-23	
ZD950	0402-000553	DIODE-RECTIFIER	SS24,40V,2.0A,DO-214AA	
ZD951	0402-000553	DIODE-RECTIFIER	SS24,40V,2.0A,DO-214AA	
ZD952	0402-000553	DIODE-RECTIFIER	SS24,40V,2.0A,DO-214AA	
ZD953	0402-000553	DIODE-RECTIFIER	SS24,40V,2.0A,DO-214AA	
ZD954	0402-000553	DIODE-RECTIFIER	SS24,40V,2.0A,DO-214AA	
ZD955	0402-000553	DIODE-RECTIFIER	SS24,40V,2.0A,DO-214AA	
-	BN94-00372A	ASSY PCB MISC-RTA PCB	AL29JO,AL29JO-SXR5/8080	SNA
CIS02	0202-001222	SOLDER-WIRE FLUX	RS-107,RS60-1.2AA,D1.2,SN60/PB40,-	SNA
CIS99	BN73-00025A	RUBBER CUSHION	AL29NO,CR,10*15,60,T4,BLACK,3M #9448	SNA
-	BN97-00157A	ASSY SMD-RTA	AL29JO,AL29JO-SXR5/8080	SNA
BD200	3301-001163	CORE-FERRITE BEAD	AB,80ohm,2x1.25x1mm,300mA,TP,FERRITE,0.08ohm	
BD700	3301-001163	CORE-FERRITE BEAD	AB,80ohm,2x1.25x1mm,300mA,TP,FERRITE,0.08ohm	
BD701	3301-001163	CORE-FERRITE BEAD	AB,80ohm,2x1.25x1mm,300mA,TP,FERRITE,0.08ohm	
BD702	3301-001163	CORE-FERRITE BEAD	AB,80ohm,2x1.25x1mm,300mA,TP,FERRITE,0.08ohm	
C106	2203-000257	C-CERAMIC,CHIP	10nF,10%,50V,X7R,TP,1608	
C107	2203-000189	C-CERAMIC,CHIP	100nF,+80-20%,25V,Y5V,TP,1608,	
C108	2402-001044	C-AL,SMD	100UF,20%,25V,GP,TP,8.3X8.3X6.3MM	
C109	2402-001044	C-AL,SMD	100UF,20%,25V,GP,TP,8.3X8.3X6.3MM	
C110	2203-000257	C-CERAMIC,CHIP	10nF,10%,50V,X7R,TP,1608	
C111	2203-000189	C-CERAMIC,CHIP	100nF,+80-20%,25V,Y5V,TP,1608,	
C112	2402-001044	C-AL,SMD	100UF,20%,25V,GP,TP,8.3X8.3X6.3MM	
C113	2402-001044	C-AL,SMD	100UF,20%,25V,GP,TP,8.3X8.3X6.3MM	

Loc. No.	Code No.	Description	Specification	Remarks
C114	2402-001044	C-AL,SMD	100UF,20%,25V,GP,TP,8.3X8.3X6.3MM	
C115	2402-000176	C-AL,SMD	10uF,20%,16V,GP,TP,4.3x4.3x5.4	
C200	2402-001155	C-AL,SMD	47UF,20%,16V,WT,TP,6.3X5.2MM	
C201	2203-000189	C-CERAMIC,CHIP	100nF,+80-20%,25V,Y5V,TP,1608,	
C202	2203-000189	C-CERAMIC,CHIP	100nF,+80-20%,25V,Y5V,TP,1608,	
C203	2203-000189	C-CERAMIC,CHIP	100nF,+80-20%,25V,Y5V,TP,1608,	
C204	2203-000189	C-CERAMIC,CHIP	100nF,+80-20%,25V,Y5V,TP,1608,	
C205	2203-000189	C-CERAMIC,CHIP	100nF,+80-20%,25V,Y5V,TP,1608,	
C206	2203-000189	C-CERAMIC,CHIP	100nF,+80-20%,25V,Y5V,TP,1608,	
C207	2203-000189	C-CERAMIC,CHIP	100nF,+80-20%,25V,Y5V,TP,1608,	
C208	2203-000189	C-CERAMIC,CHIP	100nF,+80-20%,25V,Y5V,TP,1608,	
C209	2203-000189	C-CERAMIC,CHIP	100nF,+80-20%,25V,Y5V,TP,1608,	
C210	2203-000189	C-CERAMIC,CHIP	100nF,+80-20%,25V,Y5V,TP,1608,	
C211	2203-000189	C-CERAMIC,CHIP	100nF,+80-20%,25V,Y5V,TP,1608,	
C212	2402-001155	C-AL,SMD	47UF,20%,16V,WT,TP,6.3X5.2MM	
C213	2203-000189	C-CERAMIC,CHIP	100nF,+80-20%,25V,Y5V,TP,1608,	
C214	2203-000189	C-CERAMIC,CHIP	100nF,+80-20%,25V,Y5V,TP,1608,	
C215	2203-000189	C-CERAMIC,CHIP	100nF,+80-20%,25V,Y5V,TP,1608,	
C216	2203-000189	C-CERAMIC,CHIP	100nF,+80-20%,25V,Y5V,TP,1608,	
C217	2203-000189	C-CERAMIC,CHIP	100nF,+80-20%,25V,Y5V,TP,1608,	
C218	2203-000189	C-CERAMIC,CHIP	100nF,+80-20%,25V,Y5V,TP,1608,	
C219	2203-000189	C-CERAMIC,CHIP	100nF,+80-20%,25V,Y5V,TP,1608,	
C220	2203-000189	C-CERAMIC,CHIP	100nF,+80-20%,25V,Y5V,TP,1608,	
C221	2402-001155	C-AL,SMD	47UF,20%,16V,WT,TP,6.3X5.2MM	
C222	2203-000189	C-CERAMIC,CHIP	100nF,+80-20%,25V,Y5V,TP,1608,	
C223	2203-000189	C-CERAMIC,CHIP	100nF,+80-20%,25V,Y5V,TP,1608,	
C224	2203-000189	C-CERAMIC,CHIP	100nF,+80-20%,25V,Y5V,TP,1608,	
C225	2402-001155	C-AL,SMD	47UF,20%,16V,WT,TP,6.3X5.2MM	
C226	2203-000189	C-CERAMIC,CHIP	100nF,+80-20%,25V,Y5V,TP,1608,	
C227	2203-000189	C-CERAMIC,CHIP	100nF,+80-20%,25V,Y5V,TP,1608,	
C228	2203-000189	C-CERAMIC,CHIP	100nF,+80-20%,25V,Y5V,TP,1608,	
C229	2203-000440	C-CERAMIC,CHIP	1nF,10%,50V,X7R,TP,1608,-	
C230	2402-000176	C-AL,SMD	10uF,20%,16V,GP,TP,4.3x4.3x5.4	
C231	2203-000189	C-CERAMIC,CHIP	100nF,+80-20%,25V,Y5V,TP,1608,	
C232	2203-000189	C-CERAMIC,CHIP	100nF,+80-20%,25V,Y5V,TP,1608,	
C233	2203-000189	C-CERAMIC,CHIP	100nF,+80-20%,25V,Y5V,TP,1608,	
C234	2203-000189	C-CERAMIC,CHIP	100nF,+80-20%,25V,Y5V,TP,1608,	
C235	2203-000189	C-CERAMIC,CHIP	100nF,+80-20%,25V,Y5V,TP,1608,	
C236	2203-000189	C-CERAMIC,CHIP	100nF,+80-20%,25V,Y5V,TP,1608,	
C237	2402-001044	C-AL,SMD	100UF,20%,25V,GP,TP,8.3X8.3X6.3MM	
C238	2203-000189	C-CERAMIC,CHIP	100nF,+80-20%,25V,Y5V,TP,1608,	
C239	2203-000189	C-CERAMIC,CHIP	100nF,+80-20%,25V,Y5V,TP,1608,	
C240	2203-000189	C-CERAMIC,CHIP	100nF,+80-20%,25V,Y5V,TP,1608,	
C241	2203-000189	C-CERAMIC,CHIP	100nF,+80-20%,25V,Y5V,TP,1608,	
C242	2203-000189	C-CERAMIC,CHIP	100nF,+80-20%,25V,Y5V,TP,1608,	
C243	2203-000189	C-CERAMIC,CHIP	100nF,+80-20%,25V,Y5V,TP,1608,	
C244	2203-000189	C-CERAMIC,CHIP	100nF,+80-20%,25V,Y5V,TP,1608,	
C245	2203-000189	C-CERAMIC,CHIP	100nF,+80-20%,25V,Y5V,TP,1608,	
C246	2203-000189	C-CERAMIC,CHIP	100nF,+80-20%,25V,Y5V,TP,1608,	
C247	2203-000189	C-CERAMIC,CHIP	100nF,+80-20%,25V,Y5V,TP,1608,	
C248	2203-000189	C-CERAMIC,CHIP	100nF,+80-20%,25V,Y5V,TP,1608,	
C249	2203-000189	C-CERAMIC,CHIP	100nF,+80-20%,25V,Y5V,TP,1608,	
C250	2203-000189	C-CERAMIC,CHIP	100nF,+80-20%,25V,Y5V,TP,1608,	
C251	2203-000189	C-CERAMIC,CHIP	100nF,+80-20%,25V,Y5V,TP,1608,	
C252	2203-000189	C-CERAMIC,CHIP	100nF,+80-20%,25V,Y5V,TP,1608,	
C501	2402-000176	C-AL,SMD	10uF,20%,16V,GP,TP,4.3x4.3x5.4	
C502	2203-000189	C-CERAMIC,CHIP	100nF,+80-20%,25V,Y5V,TP,1608,	
C700	2402-000176	C-AL,SMD	10uF,20%,16V,GP,TP,4.3x4.3x5.4	
C701	2203-000440	C-CERAMIC,CHIP	1nF,10%,50V,X7R,TP,1608,-	
C702	2402-000176	C-AL,SMD	10uF,20%,16V,GP,TP,4.3x4.3x5.4	
C703	2203-000440	C-CERAMIC,CHIP	1nF,10%,50V,X7R,TP,1608,-	
C704	2402-000176	C-AL,SMD	10uF,20%,16V,GP,TP,4.3x4.3x5.4	
C705	2203-000440	C-CERAMIC,CHIP	1nF,10%,50V,X7R,TP,1608,-	
C706	2203-000440	C-CERAMIC,CHIP	1nF,10%,50V,X7R,TP,1608,-	
C707	2203-000440	C-CERAMIC,CHIP	1nF,10%,50V,X7R,TP,1608,-	
C708	2203-000440	C-CERAMIC,CHIP	1nF,10%,50V,X7R,TP,1608,-	
C710	2402-001044	C-AL,SMD	100UF,20%,25V,GP,TP,8.3X8.3X6.3MM	
C711	2203-000189	C-CERAMIC,CHIP	100nF,+80-20%,25V,Y5V,TP,1608,	
C712	2203-000189	C-CERAMIC,CHIP	100nF,+80-20%,25V,Y5V,TP,1608,	
C713	2203-000189	C-CERAMIC,CHIP	100nF,+80-20%,25V,Y5V,TP,1608,	

Loc. No.	Code No.	Description	Specification	Remarks
C714	2203-000189	C-CERAMIC,CHIP	100nF,+80-20%,25V,Y5V,TP,1608,	
C715	2203-000189	C-CERAMIC,CHIP	100nF,+80-20%,25V,Y5V,TP,1608,	
C716	2203-000189	C-CERAMIC,CHIP	100nF,+80-20%,25V,Y5V,TP,1608,	
C717	2203-000189	C-CERAMIC,CHIP	100nF,+80-20%,25V,Y5V,TP,1608,	
C718	2203-000189	C-CERAMIC,CHIP	100nF,+80-20%,25V,Y5V,TP,1608,	
C719	2203-000189	C-CERAMIC,CHIP	100nF,+80-20%,25V,Y5V,TP,1608,	
C720	2203-000189	C-CERAMIC,CHIP	100nF,+80-20%,25V,Y5V,TP,1608,	
C721	2203-000189	C-CERAMIC,CHIP	100nF,+80-20%,25V,Y5V,TP,1608,	
C722	2203-000189	C-CERAMIC,CHIP	100nF,+80-20%,25V,Y5V,TP,1608,	
C723	2203-000189	C-CERAMIC,CHIP	100nF,+80-20%,25V,Y5V,TP,1608,	
C724	2203-000189	C-CERAMIC,CHIP	100nF,+80-20%,25V,Y5V,TP,1608,	
C725	2203-000189	C-CERAMIC,CHIP	100nF,+80-20%,25V,Y5V,TP,1608,	
CIS	0202-001162	SOLDER-CREAM	RMA-20-21L,S63,-,SN63/PB36.6/AGO.4,FLUX9.5%	SNA
CN200	3711-002046	CONNECTOR-HEADER	3WALL,12P,1R,1.25mm,SMD-S,SN	SNA
CN701	3711-004070	CONNECTOR-HEADER	BOX,30P,1R,1.25mm,SMD-A,SN	SNA
CN904	3708-001776	CONNECTOR-FPC/FFC/PIC	34P,0.5MM,SMD-A,SN	
CN905	3708-001775	CONNECTOR-FPC/FFC/PIC	30P,0.5MM,SMD-A,SN	
D200	0402-000553	DIODE-RECTIFIER	SS24,40V,2.0A,DO-214AA	
FT100	3301-001145	CORE-FERRITE BEAD	AB,4.5x1.6x1.6mm,-,-	SNA
FT101	3301-001145	CORE-FERRITE BEAD	AB,4.5x1.6x1.6mm,-,-	SNA
FT200	3301-001145	CORE-FERRITE BEAD	AB,4.5x1.6x1.6mm,-,-	SNA
FT201	3301-001145	CORE-FERRITE BEAD	AB,4.5x1.6x1.6mm,-,-	SNA
FT202	3301-001145	CORE-FERRITE BEAD	AB,4.5x1.6x1.6mm,-,-	SNA
FT203	3301-001145	CORE-FERRITE BEAD	AB,4.5x1.6x1.6mm,-,-	SNA
FT204	3301-001145	CORE-FERRITE BEAD	AB,4.5x1.6x1.6mm,-,-	SNA
FT205	3301-001145	CORE-FERRITE BEAD	AB,4.5x1.6x1.6mm,-,-	SNA
IC102	1203-002411	IC-POSI.FIXED REG.	IRU1030-33CM,TO-263,3P,-,PLASTIC,3.267/3.333V,-,OTO+150C,-,-,ST	
IC103	1203-002454	IC-VOLTAGE REGULATOR	FAN1117A,TO-252,3P,257MIL,PLASTIC,1.764V/1.836V,-,OTO+125C,1A,1.225/1.275V,TP	
IC104	1203-002411	IC-POSI.FIXED REG.	IRU1030-33CM,TO-263,3P,-,PLASTIC,3.267/3.333V,-,OTO+150C,-,-,ST	
IC200	1101-001060	IC-PROM	EPC8,8MBIT,POFP,100P,20X14MM,-,3.3V,5%,PLASTIC,OTO+70C,100UA,CMOS,TR	
IC201	1301-001591	IC-FPGA	EP20K300E-652,BGA,652P,45X45MM,2.5NS,1.8V,10%,25MA,OTO+85C,PLASTIC,,,,,,,,,	
IC202	1105-001165	IC-DRAM	416S1020,512Kx16BITx2,TSOP,50P	
IC203	1105-001165	IC-DRAM	416S1020,512Kx16BITx2,TSOP,50P	
IC204	1105-001165	IC-DRAM	416S1020,512Kx16BITx2,TSOP,50P	
IC700	1205-001740	IC-TRANSMITTER	DS90C385,TSSOP,56P,240MIL,PLASTIC,4V,1.63W,-10 TO +70C,ST,FPD LINK-85MHZ(LVDS)	
IC701	1205-001740	IC-TRANSMITTER	DS90C385,TSSOP,56P,240MIL,PLASTIC,4V,1.63W,-10 TO +70C,ST,FPD LINK-85MHZ(LVDS)	
IC702	1105-001165	IC-DRAM	416S1020,512Kx16BITx2,TSOP,50P	
IC703	1105-001165	IC-DRAM	416S1020,512Kx16BITx2,TSOP,50P	
IC704	1105-001165	IC-DRAM	416S1020,512Kx16BITx2,TSOP,50P	
L100	2703-001778	INDUCTOR-SMD	3.3UH,20%,3.2X2.5X2.2MM	
MP1.0	BN41-00203A	PCB SUB	APOLLO_FR4,6L,1.6,80*210,APOLLO_RT	SNA
R127	2007-000084	R-CHIP	4.7Kohm,5%,1/16W,DA,TP,1608	
R128	2007-000084	R-CHIP	4.7Kohm,5%,1/16W,DA,TP,1608	
R182	2007-000070	R-CHIP	0ohm,5%,1/16W,DA,TP,1608	
R200	2007-000090	R-CHIP	10KOHM,5%,1/16W,DA,TP,1608	
R202	2007-000078	R-CHIP	1Kohm,5%,1/16W,DA,TP,1608	
R203	2007-000078	R-CHIP	1Kohm,5%,1/16W,DA,TP,1608	
R204	2007-000078	R-CHIP	1Kohm,5%,1/16W,DA,TP,1608	
R205	2007-000070	R-CHIP	0ohm,5%,1/16W,DA,TP,1608	
R206	2007-000078	R-CHIP	1Kohm,5%,1/16W,DA,TP,1608	
R207	2007-000070	R-CHIP	0ohm,5%,1/16W,DA,TP,1608	
R208	2007-000070	R-CHIP	0ohm,5%,1/16W,DA,TP,1608	
R209	2007-000070	R-CHIP	0ohm,5%,1/16W,DA,TP,1608	
R210	2007-000070	R-CHIP	0ohm,5%,1/16W,DA,TP,1608	
R211	2007-000070	R-CHIP	0ohm,5%,1/16W,DA,TP,1608	
R212	2007-000070	R-CHIP	0ohm,5%,1/16W,DA,TP,1608	
R213	2007-000070	R-CHIP	0ohm,5%,1/16W,DA,TP,1608	
R214	2007-000070	R-CHIP	0ohm,5%,1/16W,DA,TP,1608	
R215	2007-000070	R-CHIP	0ohm,5%,1/16W,DA,TP,1608	
R216	2007-000070	R-CHIP	0ohm,5%,1/16W,DA,TP,1608	
R217	2007-000070	R-CHIP	0ohm,5%,1/16W,DA,TP,1608	
R218	2007-000070	R-CHIP	0ohm,5%,1/16W,DA,TP,1608	
R219	2007-000070	R-CHIP	0ohm,5%,1/16W,DA,TP,1608	
R220	2007-000070	R-CHIP	0ohm,5%,1/16W,DA,TP,1608	
R221	2007-000070	R-CHIP	0ohm,5%,1/16W,DA,TP,1608	
R222	2007-000070	R-CHIP	0ohm,5%,1/16W,DA,TP,1608	
R223	2007-000070	R-CHIP	0ohm,5%,1/16W,DA,TP,1608	
R224	2007-000070	R-CHIP	0ohm,5%,1/16W,DA,TP,1608	
R225	2007-000070	R-CHIP	0ohm,5%,1/16W,DA,TP,1608	
R226	2007-000070	R-CHIP	0ohm,5%,1/16W,DA,TP,1608	

















Loc. No.	Code No.	Description	Specification	Remarks
CIS	BN63-00445A	GASKET	29 APOLLO, CONDUCTIVE FABRIC, 5MM, 10MM, 225MM, GRAY, 71TSSK-10-RS5-225-13, 71TSSK-10-	SNA
CIS	BN63-00446A	GASKET	29 APOLLO, CONDUCTIVE FABRIC, 18MM, 25MM, 225MM, GRAY, 71TSSK-25-18-225-13, 71TSSK-25-	SNA
CIS	BN63-00447A	GASKET	29 APOLLO, CONDUCTIVE FABRIC, 18MM, 25MM, 30MM, GRAY, 71TSSK-25-18-30-13, 71TSSK-25-18-	SNA
CIS	BN63-00448A	GASKET	29 APOLLO, CONDUCTIVE FABRIC, 18MM, 25MM, 270MM, GRAY, 71TSSK-25-18-270-13, 71TSSK-25-	SNA
CIS	BN63-00451A	GASKET	29 40APOLLO, CONDUCTIVE FABRIC, 5MM, 10MM, 290MM, GRAY, 71TSSK-10-RS5-290-13, 71TSSK-	SNA
CIS	BN63-00452A	GASKET	29 APOLLO, CONDUCTIVE FABRIC, 18MM, 25MM, 250MM, GRAY, 71TSSK-25-18-250-13, 71TSSK-25-	SNA
CIS	BN63-00485A	GASKET	APOLLO29, CONDUCTIVE FABRIC, 13MM, 26MM, 510MM, GRAY, 71TSSK26-13-510-13, 71TSSK26-13-	SNA
CIS	BN96-00211A	ASSY MISC P-PANEL-STUD	APOLLO29, SECC T0.8 110*220, TAPE	SNA
-	BN92-00431A	ASSY P/MATERIAL	AL29NO	SNA
CIS	0203-001102	TAPE-OPP MASKING	OPP-2, T0.05, W100, L400M, CLR	SNA
CIS	BN69-00256C	PAD-PACKING-EDGE	MV940, B400, W200, L2030, -, -, YEL, -, -	SNA
CIS	BH69-30355F	BAG-PE/N	AL40AO, PE FOAM, 0.5, 320, 210, NTR	SNA
CIS	BH69-30355J	BAG-PE	AL29AO, PE FOAM, 0.5, 800, 850, NTR	SNA
CIS	BH69-30360A	BAG-AIR	HDPE, T0.2, W1000*L1800, N, -, ALL	SNA
CIS	BH69-40379A	PACKING-WRAP	LDPE, W500*T0.02, -, -	SNA
CIS	BN69-00131K	PALLET-PACKING	AL29NO, WOODEN, 1350, 900, 120	SNA
CIS	BN69-00286A	CUSHION-SET-L/R	APOLLO29, EPS 50M	SNA
-	BN92-00582M	ASSY LABEL	LT29A13WX/XSJ, SJC, JAPAN	SNA
CIS	AA68-01404A	LABEL-MANUFACTURED	, T/P, T0.05, 25, 10, JAPAN	SNA
CIS	AA68-50057E	LABEL-WARNING	, A/P 90G, 58, 52, JAPAN	SNA
CIS	BN68-00269B	LABEL RATING	, TETRONE, T0.05, 64, 78, NO PRINT	SNA
-	BN92-00584F	ASSY BOX	LT29A13WX/XSJ, SEJ, JAPAN	SNA
BOX	AA68-50054L	LABEL-STICKER	, A/P 90G, 80, 23, SERIAL	SNA
BOX	BN68-00305A	LABEL-BAR CODE	LT29A13W, A/P(90G), 46, 22	SNA
BOX	BN69-00333B	PACKING-CASE	LT29A13W, D-3 AB, A1, YEL, JAPAN	SNA
CIS	AA68-40069B	CARD-WARRANTY	JAPAN, -, -, YEL, JAPAN, -	SNA
CIS	BN68-00174F	MANUAL	APOLLO W'TY CARD, SYNCMASTER, JAPANESE, JAPAN, MIMOJO80G	SNA
-	BN92-00626T	ASSY ACCESSORY	LT29A13WX/XSJ	SNA
CIS	BN59-00314A	REMOCON	, TM63, APPOLO, 47, G6671B, NTSC, EX, JAPAN	SNA
-	2802-000194	RESONATOR-CERAMIC	8MHz, 1.0%, TP, 8.5x4.5x5.0mm	SNA
-	AA09-00275A	IC MICOM	Z86L8808SSC-R51PX, SOP, ST, SZTM-828A2	SNA
CIS	BN96-00205T	ASSY ACCESSORY	LT29A13WX/XSJ	SNA
CIS	0203-000214	TAPE-OPP MASKING	OPP/W50/CLR, T0.05, W50, L400000,	SNA
CIS	4301-000121	BATTERY-MN	1.5V, -, AAA, 10.5x44.5m, HOLDER	SNA
CIS	6003-001310	SCREW-TAPTITE	BH, + B, M4, L16, ZPC(BLK), SWRCH18A	SNA
CIS	AA65-30101A	CLAMPER CORE-BACK	-, PE, VO, -, BLK, TOSHIBA	SNA
CIS	BH39-00120A	CBF SIGNAL	-, 2000MM, -, -, UL2851#28, -	SNA
CIS	BH39-10307W	CBF POWER CORD	, VCTF, -, IVY, 1830MM, N, LP-54, LS1	SNA
CIS	BH69-30348D	BAG-PE	LDPE, T0.05, W240*L356, Y, -, CMG73	SNA
CIS	BN39-00057A	CBF SIGNAL-RCA	-, 1500MM, RCA-3P, -, UL2863#25, -	SNA
CIS	BN39-00060A	CBF SIGNAL-DIN	-, 1500MM, -, -, UL2990, 4P MINI DIN	SNA
CIS	BN39-00072A	CBF SIGNAL	DET, 2000MM, 24P/24P, IVORY, -, DVI-D(M) TO DVI-D(M)	SNA
CIS	BN39-00310A	CBF SIGNAL	APOLLO, 15P/24P, 2990, 1830MM, UL2990, IVORY, D-SUB/DVI(D), DET. TYPE	SNA
CIS	BN68-00275C	MANUAL USERS	LT29A13W, LT40A13W, SAMSUNG, JAPANESE, JAPAN, MIMOJO80G	SNA
CIS	BN69-00350B	BOX-ACCESSORY	AL29NO/AO, CB SW-1, YEL, KSD-21, 60, 300, 230, 3 COLOR PRINTING	SNA

**6-2-1 LT40A13W Main PCB Parts**

Loc. No.	Code No.	Description	Specification	Remarks
-	BN94-00363A	ASSY PCB MAIN	AL40JO	SNA
CIS01	6001-000677	SCREW-MACHINE	RH,+ ,M3,L6,ZPC(YEL),SM20C,-	SNA
CIS04	0202-001044	SOLDER-WIRE.	S63S-W3.0,S63S,D3,63Sn/37Pb,-	SNA
CIS05	0202-001162	SOLDER-CREAM	RMA-20-21L,S63,-,SN63/PB36.6/AGO.4,FLUX9.5%	SNA
CIS06	0202-001172	SOLDER-WIRE FLUX	RS-107,RS60,D1.2,SN60/PB40,-	SNA
CIS07	0204-001096	ETHANOL	ISO-PROPYLENE,C2H5OH,99.8%,-	SNA
CIS08	0204-001527	FLUX	DF-201TVS,MIX,0.820,FLUX 13%, 14KG	SNA
CIS99	BN73-00025A	RUBBER CUSHION	AL29NO,CR,10*15.60,T4 BLACK,3M #9448	SNA
CN2	3711-004261	CONNECTOR-HEADER	BOX,12P,1R,2MM,ANGLE,SN	SNA
CN501	3711-004123	CONNECTOR-HEADER	BOX,15P,1R,2mm,ANGLE,SN	SNA
CN950	3711-003846	CONNECTOR-HEADER	BOX,8P,1R,2mm,ANGLE,SN	SNA
IC1	1001-001037	IC-RF/VI/AUDIO S/W	TA8851CN,-,DIP,54P,600MIL,SING	SNA
L901	BN27-00012A	COIL CHOKE	5UH,APPOLO,5UH,10%,0.010HM MAX,10A,PEI3210S,1T,40X70X25MM,BK,-10CTO+85C	
X102	2801-003224	CRYSTAL-UNIT	32.768KHz,20ppm,28-AA Y, 12.5pF,	
CIS	BN96-00093A	ASSY MISC P-SHIELD/D-SUB	AL29NO,SPT E T0.5	SNA
CIS03	BN97-00115X	ASSY MICOM	AL40JO	
IC105	1102-001108	IC-EPROM	27C020,256Kx8Bit,PLCC,32P,495MIL,70nS,5V,10%,PLASTIC,0to+70C,100uA,CMOS,TR	
CIS	BN46-00014S	S/W MICOM-S/W	AL40JO	SNA
-	BN97-00151A	ASSY SMD	AL40JO	SNA
BD1	2703-001334	INDUCTOR-SMD	1.5uH,10%,2x1.25x0.85mm	
BD2	2703-001334	INDUCTOR-SMD	1.5uH,10%,2x1.25x0.85mm	
BD201	3301-001176	CORE-FERRITE BEAD	AB,2x1.25x0.9mm,-,-	
BD202	3301-001176	CORE-FERRITE BEAD	AB,2x1.25x0.9mm,-,-	
BD203	3301-001176	CORE-FERRITE BEAD	AB,2x1.25x0.9mm,-,-	
BD3	2703-001334	INDUCTOR-SMD	1.5uH,10%,2x1.25x0.85mm	
BD301	3301-001176	CORE-FERRITE BEAD	AB,2x1.25x0.9mm,-,-	
BD302	3301-001176	CORE-FERRITE BEAD	AB,2x1.25x0.9mm,-,-	
BD303	3301-001176	CORE-FERRITE BEAD	AB,2x1.25x0.9mm,-,-	
BD304	3301-001176	CORE-FERRITE BEAD	AB,2x1.25x0.9mm,-,-	
BD4	2703-001334	INDUCTOR-SMD	1.5uH,10%,2x1.25x0.85mm	
BD401	3301-001176	CORE-FERRITE BEAD	AB,2x1.25x0.9mm,-,-	
BD402	3301-001176	CORE-FERRITE BEAD	AB,2x1.25x0.9mm,-,-	
BD403	3301-001176	CORE-FERRITE BEAD	AB,2x1.25x0.9mm,-,-	
BD404	3301-001176	CORE-FERRITE BEAD	AB,2x1.25x0.9mm,-,-	
BD405	3301-001176	CORE-FERRITE BEAD	AB,2x1.25x0.9mm,-,-	
BD406	3301-001176	CORE-FERRITE BEAD	AB,2x1.25x0.9mm,-,-	
BD407	3301-001176	CORE-FERRITE BEAD	AB,2x1.25x0.9mm,-,-	
BD501	3301-001145	CORE-FERRITE BEAD	AB,4.5x1.6x1.6mm,-,-	
C1	2409-001065	C-ORGANIC	82UF,20%,16V,WT,TP,8X6.9MM,-	
C10	2402-001155	C-AL,SMD	47UF,20%,16V,WT,TP,6.3X5.2MM	
C1001	2402-001044	C-AL,SMD	100UF,20%,25V,GP,TP,8.3X8.3X6.3MM	
C1002	2203-000257	C-CERAMIC,CHIP	10nF,10%,50V,X7R,TP,1608	
C1003	2203-000189	C-CERAMIC,CHIP	100nF,+80-20%,25V,Y5V,TP,1608,	
C1004	2203-005137	C-CERAMIC,CHIP	10uF,+80-20%,50V,JE,TP,5650,-	
C1005	2203-005137	C-CERAMIC,CHIP	10uF,+80-20%,50V,JE,TP,5650,-	
C1006	2203-005005	C-CERAMIC,CHIP	100nF,10%,16V,X7R,TP,1608	
C1007	2203-005005	C-CERAMIC,CHIP	100nF,10%,16V,X7R,TP,1608	
C1008	2203-005005	C-CERAMIC,CHIP	100nF,10%,16V,X7R,TP,1608	
C1009	2409-001035	C-ORGANIC	10uF,20%,10V,LZ,TP,5.4x4.3x4.3mm,1	
C101	2203-000189	C-CERAMIC,CHIP	100nF,+80-20%,25V,Y5V,TP,1608,	
C1010	2402-000176	C-AL,SMD	10uF,20%,16V,GP,TP,4.3x4.3x5.4	
C1011	2402-000176	C-AL,SMD	10uF,20%,16V,GP,TP,4.3x4.3x5.4	
C1012	2203-005005	C-CERAMIC,CHIP	100nF,10%,16V,X7R,TP,1608	
C1013	2203-000257	C-CERAMIC,CHIP	10nF,10%,50V,X7R,TP,1608	
C1014	2203-005065	C-CERAMIC,CHIP	1000nF,+80-20%,10V,Y5V,TP,1608	
C1015	2203-001851	C-CERAMIC,CHIP	0.016nF,5%,50V,NP0,TP,1608	
C1016	2203-001652	C-CERAMIC,CHIP	470nF,+80-20%,16V,Y5V,TP,1608	
C1017	2203-001652	C-CERAMIC,CHIP	470nF,+80-20%,16V,Y5V,TP,1608	
C1018	2203-001652	C-CERAMIC,CHIP	470nF,+80-20%,16V,Y5V,TP,1608	
C1019	2203-001652	C-CERAMIC,CHIP	470nF,+80-20%,16V,Y5V,TP,1608	
C102	2203-000189	C-CERAMIC,CHIP	100nF,+80-20%,25V,Y5V,TP,1608,	
C1020	2203-001652	C-CERAMIC,CHIP	470nF,+80-20%,16V,Y5V,TP,1608	
C1021	2203-001652	C-CERAMIC,CHIP	470nF,+80-20%,16V,Y5V,TP,1608	
C1022	2203-001652	C-CERAMIC,CHIP	470nF,+80-20%,16V,Y5V,TP,1608	
C1023	2203-001652	C-CERAMIC,CHIP	470nF,+80-20%,16V,Y5V,TP,1608	
C1024	2203-001652	C-CERAMIC,CHIP	470nF,+80-20%,16V,Y5V,TP,1608	
C1025	2203-001652	C-CERAMIC,CHIP	470nF,+80-20%,16V,Y5V,TP,1608	
C1026	2203-001652	C-CERAMIC,CHIP	470nF,+80-20%,16V,Y5V,TP,1608	

Loc. No.	Code No.	Description	Specification	Remarks
C1027	2203-001652	C-CERAMIC,CHIP	470nF,+80-20%,16V,Y5V,TP,1608	
C1028	2203-001652	C-CERAMIC,CHIP	470nF,+80-20%,16V,Y5V,TP,1608	
C1029	2203-001652	C-CERAMIC,CHIP	470nF,+80-20%,16V,Y5V,TP,1608	
C103	2203-000189	C-CERAMIC,CHIP	100nF,+80-20%,25V,Y5V,TP,1608	
C1030	2203-001652	C-CERAMIC,CHIP	470nF,+80-20%,16V,Y5V,TP,1608	
C1031	2203-001652	C-CERAMIC,CHIP	470nF,+80-20%,16V,Y5V,TP,1608	
C104	2203-000189	C-CERAMIC,CHIP	100nF,+80-20%,25V,Y5V,TP,1608	
C105	2203-000189	C-CERAMIC,CHIP	100nF,+80-20%,25V,Y5V,TP,1608	
C106	2203-000189	C-CERAMIC,CHIP	100nF,+80-20%,25V,Y5V,TP,1608	
C107	2203-000815	C-CERAMIC,CHIP	0.033nF,5%,50V,NP0,TP,1608	
C108	2203-000815	C-CERAMIC,CHIP	0.033nF,5%,50V,NP0,TP,1608	
C109	2203-000189	C-CERAMIC,CHIP	100nF,+80-20%,25V,Y5V,TP,1608	
C11	2402-000170	C-AL,SMD	1uF,20%,50V,GP,TP,4.3x4.3x5.4	
C111	2203-000189	C-CERAMIC,CHIP	100nF,+80-20%,25V,Y5V,TP,1608	
C112	2203-000189	C-CERAMIC,CHIP	100nF,+80-20%,25V,Y5V,TP,1608	
C113	2203-000189	C-CERAMIC,CHIP	100nF,+80-20%,25V,Y5V,TP,1608	
C114	2203-000189	C-CERAMIC,CHIP	100nF,+80-20%,25V,Y5V,TP,1608	
C115	2203-000552	C-CERAMIC,CHIP	0.02nF,5%,50V,NP0,TP,1608	
C12	2402-000176	C-AL,SMD	10uF,20%,16V,GP,TP,4.3x4.3x5.4	
C13	2203-000440	C-CERAMIC,CHIP	1nF,10%,50V,X7R,TP,1608,-	
C14	2402-000170	C-AL,SMD	1uF,20%,50V,GP,TP,4.3x4.3x5.4	
C15	2203-000236	C-CERAMIC,CHIP	0.1nF,5%,50V,NP0,TP,1608	
C16	2203-000236	C-CERAMIC,CHIP	0.1nF,5%,50V,NP0,TP,1608	
C17	2203-000189	C-CERAMIC,CHIP	100nF,+80-20%,25V,Y5V,TP,1608	
C18	2203-000189	C-CERAMIC,CHIP	100nF,+80-20%,25V,Y5V,TP,1608	
C19	2402-000209	C-AL,SMD	22uF,20%,16V,WT,TP,5.3x5.3mm,1	
C2	2203-000189	C-CERAMIC,CHIP	100nF,+80-20%,25V,Y5V,TP,1608	
C20	2402-000209	C-AL,SMD	22uF,20%,16V,WT,TP,5.3x5.3mm,1	
C201	2409-001035	C-ORGANIC	10uF,20%,10V,LZ,TP,5.4x4.3x4.3mm,1	
C202	2203-005005	C-CERAMIC,CHIP	100nF,10%,16V,X7R,TP,1608	
C203	2203-005005	C-CERAMIC,CHIP	100nF,10%,16V,X7R,TP,1608	
C204	2203-005005	C-CERAMIC,CHIP	100nF,10%,16V,X7R,TP,1608	
C205	2203-005005	C-CERAMIC,CHIP	100nF,10%,16V,X7R,TP,1608	
C206	2203-005005	C-CERAMIC,CHIP	100nF,10%,16V,X7R,TP,1608	
C207	2409-001035	C-ORGANIC	10uF,20%,10V,LZ,TP,5.4x4.3x4.3mm,1	
C208	2203-005005	C-CERAMIC,CHIP	100nF,10%,16V,X7R,TP,1608	
C209	2203-005005	C-CERAMIC,CHIP	100nF,10%,16V,X7R,TP,1608	
C210	2203-005005	C-CERAMIC,CHIP	100nF,10%,16V,X7R,TP,1608	
C211	2203-005005	C-CERAMIC,CHIP	100nF,10%,16V,X7R,TP,1608	
C212	2203-005005	C-CERAMIC,CHIP	100nF,10%,16V,X7R,TP,1608	
C213	2203-005005	C-CERAMIC,CHIP	100nF,10%,16V,X7R,TP,1608	
C214	2203-005005	C-CERAMIC,CHIP	100nF,10%,16V,X7R,TP,1608	
C215	2203-005005	C-CERAMIC,CHIP	100nF,10%,16V,X7R,TP,1608	
C216	2203-005005	C-CERAMIC,CHIP	100nF,10%,16V,X7R,TP,1608	
C217	2203-000189	C-CERAMIC,CHIP	100nF,+80-20%,25V,Y5V,TP,1608	
C218	2203-000189	C-CERAMIC,CHIP	100nF,+80-20%,25V,Y5V,TP,1608	
C219	2402-000176	C-AL,SMD	10uF,20%,16V,GP,TP,4.3x4.3x5.4	
C22	2203-000257	C-CERAMIC,CHIP	10nF,10%,50V,X7R,TP,1608	
C220	2203-005005	C-CERAMIC,CHIP	100nF,10%,16V,X7R,TP,1608	
C221	2203-005005	C-CERAMIC,CHIP	100nF,10%,16V,X7R,TP,1608	
C222	2203-005005	C-CERAMIC,CHIP	100nF,10%,16V,X7R,TP,1608	
C223	2203-005005	C-CERAMIC,CHIP	100nF,10%,16V,X7R,TP,1608	
C224	2203-005005	C-CERAMIC,CHIP	100nF,10%,16V,X7R,TP,1608	
C225	2402-000108	C-AL,SMD	10uF,20%,16V,WT,TP,4.3x4.3x5.4	
C226	2203-000440	C-CERAMIC,CHIP	1nF,10%,50V,X7R,TP,1608,-	
C227	2203-000440	C-CERAMIC,CHIP	1nF,10%,50V,X7R,TP,1608,-	
C228	2203-000384	C-CERAMIC,CHIP	0.015nF,5%,50V,NP0,TP,1608	
C229	2203-005005	C-CERAMIC,CHIP	100nF,10%,16V,X7R,TP,1608	
C23	2203-000189	C-CERAMIC,CHIP	100nF,+80-20%,25V,Y5V,TP,1608	
C230	2203-000440	C-CERAMIC,CHIP	1nF,10%,50V,X7R,TP,1608,-	
C231	2203-005005	C-CERAMIC,CHIP	100nF,10%,16V,X7R,TP,1608	
C232	2203-000843	C-CERAMIC,CHIP	39nF,10%,25V,X7R,TP,1608,-	
C233	2203-000726	C-CERAMIC,CHIP	3.9nF,10%,50V,X7R,TP,1608,-	
C234	2203-000972	C-CERAMIC,CHIP	47nF,10%,16V,X7R,TP,1608	
C235	2203-000972	C-CERAMIC,CHIP	47nF,10%,16V,X7R,TP,1608	
C236	2203-000972	C-CERAMIC,CHIP	47nF,10%,16V,X7R,TP,1608	
C237	2402-000176	C-AL,SMD	10uF,20%,16V,GP,TP,4.3x4.3x5.4	
C238	2203-005005	C-CERAMIC,CHIP	100nF,10%,16V,X7R,TP,1608	
C239	2203-005005	C-CERAMIC,CHIP	100nF,10%,16V,X7R,TP,1608	
C24	2203-000189	C-CERAMIC,CHIP	100nF,+80-20%,25V,Y5V,TP,1608	
C240	2203-005005	C-CERAMIC,CHIP	100nF,10%,16V,X7R,TP,1608	

SNA

Loc. No.	Code No.	Description	Specification	Remarks
C241	2203-005005	C-CERAMIC,CHIP	100nF,10%,16V,X7R,TP,1608	
C242	2203-005005	C-CERAMIC,CHIP	100nF,10%,16V,X7R,TP,1608	
C243	2402-000176	C-AL,SMD	10uF,20%,16V,GP,TP,4.3x4.3x5.4	
C244	2203-005005	C-CERAMIC,CHIP	100nF,10%,16V,X7R,TP,1608	
C245	2203-005005	C-CERAMIC,CHIP	100nF,10%,16V,X7R,TP,1608	
C246	2203-005005	C-CERAMIC,CHIP	100nF,10%,16V,X7R,TP,1608	
C247	2402-000176	C-AL,SMD	10uF,20%,16V,GP,TP,4.3x4.3x5.4	
C248	2409-001035	C-ORGANIC	10uF,20%,10V,LZ,TP,5.4x4.3x4.3mm,1	
C249	2203-005005	C-CERAMIC,CHIP	100nF,10%,16V,X7R,TP,1608	
C25	2203-000357	C-CERAMIC,CHIP	0.15nF,5%,50V,NPO,TP,1608	
C250	2203-005005	C-CERAMIC,CHIP	100nF,10%,16V,X7R,TP,1608	
C251	2203-005005	C-CERAMIC,CHIP	100nF,10%,16V,X7R,TP,1608	
C252	2203-005005	C-CERAMIC,CHIP	100nF,10%,16V,X7R,TP,1608	
C253	2203-005005	C-CERAMIC,CHIP	100nF,10%,16V,X7R,TP,1608	
C254	2203-000189	C-CERAMIC,CHIP	100nF,+80-20%,25V,Y5V,TP,1608,	
C255	2203-000189	C-CERAMIC,CHIP	100nF,+80-20%,25V,Y5V,TP,1608,	
C256	2203-000189	C-CERAMIC,CHIP	100nF,+80-20%,25V,Y5V,TP,1608,	
C257	2203-000257	C-CERAMIC,CHIP	10nF,10%,50V,X7R,TP,1608	
C258	2203-000440	C-CERAMIC,CHIP	1nF,10%,50V,X7R,TP,1608,-	
C26	2203-000357	C-CERAMIC,CHIP	0.15nF,5%,50V,NPO,TP,1608	
C260	2402-000176	C-AL,SMD	10uF,20%,16V,GP,TP,4.3x4.3x5.4	
C261	2203-005005	C-CERAMIC,CHIP	100nF,10%,16V,X7R,TP,1608	
C262	2203-005005	C-CERAMIC,CHIP	100nF,10%,16V,X7R,TP,1608	
C263	2203-005005	C-CERAMIC,CHIP	100nF,10%,16V,X7R,TP,1608	
C264	2203-005005	C-CERAMIC,CHIP	100nF,10%,16V,X7R,TP,1608	
C265	2203-005005	C-CERAMIC,CHIP	100nF,10%,16V,X7R,TP,1608	
C266	2203-000440	C-CERAMIC,CHIP	1nF,10%,50V,X7R,TP,1608,-	
C267	2203-000440	C-CERAMIC,CHIP	1nF,10%,50V,X7R,TP,1608,-	
C268	2203-000440	C-CERAMIC,CHIP	1nF,10%,50V,X7R,TP,1608,-	
C269	2203-000440	C-CERAMIC,CHIP	1nF,10%,50V,X7R,TP,1608,-	
C27	2402-001155	C-AL,SMD	47uF,20%,16V,WT,TP,6.3x5.2MM	
C272	2203-000384	C-CERAMIC,CHIP	0.015nF,5%,50V,NPO,TP,1608	
C28	2203-000626	C-CERAMIC,CHIP	0.022nF,5%,50V,NPO,TP,1608	
C29	2203-000189	C-CERAMIC,CHIP	100nF,+80-20%,25V,Y5V,TP,1608,	
C299	2402-001044	C-AL,SMD	100uF,20%,25V,GP,TP,8.3x8.3x6.3MM	
C3	2402-000176	C-AL,SMD	10uF,20%,16V,GP,TP,4.3x4.3x5.4	
C30	2203-000189	C-CERAMIC,CHIP	100nF,+80-20%,25V,Y5V,TP,1608,	
C301	2203-000626	C-CERAMIC,CHIP	0.022nF,5%,50V,NPO,TP,1608	
C302	2409-001065	C-ORGANIC	82uF,20%,16V,WT,TP,8x6.9MM,-	
C303	2402-000176	C-AL,SMD	10uF,20%,16V,GP,TP,4.3x4.3x5.4	
C304	2203-000626	C-CERAMIC,CHIP	0.022nF,5%,50V,NPO,TP,1608	
C305	2203-005065	C-CERAMIC,CHIP	1000nF,+80-20%,10V,Y5V,TP,1608	
C306	2203-005065	C-CERAMIC,CHIP	1000nF,+80-20%,10V,Y5V,TP,1608	
C307	2203-005065	C-CERAMIC,CHIP	1000nF,+80-20%,10V,Y5V,TP,1608	
C308	2409-001029	C-ORGANIC	120uF,20%,6.3V,WT,TP,10.3x10.3x10.3mm,9	
C309	2203-005065	C-CERAMIC,CHIP	1000nF,+80-20%,10V,Y5V,TP,1608	
C31	2203-000626	C-CERAMIC,CHIP	0.022nF,5%,50V,NPO,TP,1608	
C310	2203-005065	C-CERAMIC,CHIP	1000nF,+80-20%,10V,Y5V,TP,1608	
C311	2409-001029	C-ORGANIC	120uF,20%,6.3V,WT,TP,10.3x10.3x10.3mm,9	
C312	2409-001029	C-ORGANIC	120uF,20%,6.3V,WT,TP,10.3x10.3x10.3mm,9	
C313	2203-005065	C-CERAMIC,CHIP	1000nF,+80-20%,10V,Y5V,TP,1608	
C314	2203-005065	C-CERAMIC,CHIP	1000nF,+80-20%,10V,Y5V,TP,1608	
C315	2203-005065	C-CERAMIC,CHIP	1000nF,+80-20%,10V,Y5V,TP,1608	
C316	2203-005065	C-CERAMIC,CHIP	1000nF,+80-20%,10V,Y5V,TP,1608	
C317	2203-005065	C-CERAMIC,CHIP	1000nF,+80-20%,10V,Y5V,TP,1608	
C318	2409-001029	C-ORGANIC	120uF,20%,6.3V,WT,TP,10.3x10.3x10.3mm,9	
C319	2409-001029	C-ORGANIC	120uF,20%,6.3V,WT,TP,10.3x10.3x10.3mm,9	
C32	2203-000189	C-CERAMIC,CHIP	100nF,+80-20%,25V,Y5V,TP,1608,	
C320	2203-005065	C-CERAMIC,CHIP	1000nF,+80-20%,10V,Y5V,TP,1608	
C321	2203-005065	C-CERAMIC,CHIP	1000nF,+80-20%,10V,Y5V,TP,1608	
C322	2203-005065	C-CERAMIC,CHIP	1000nF,+80-20%,10V,Y5V,TP,1608	
C323	2203-005065	C-CERAMIC,CHIP	1000nF,+80-20%,10V,Y5V,TP,1608	
C324	2203-000189	C-CERAMIC,CHIP	100nF,+80-20%,25V,Y5V,TP,1608,	
C325	2203-000189	C-CERAMIC,CHIP	100nF,+80-20%,25V,Y5V,TP,1608,	
C326	2203-000189	C-CERAMIC,CHIP	100nF,+80-20%,25V,Y5V,TP,1608,	
C327	2203-000189	C-CERAMIC,CHIP	100nF,+80-20%,25V,Y5V,TP,1608,	
C328	2203-000189	C-CERAMIC,CHIP	100nF,+80-20%,25V,Y5V,TP,1608,	
C329	2203-000189	C-CERAMIC,CHIP	100nF,+80-20%,25V,Y5V,TP,1608,	
C33	2203-000189	C-CERAMIC,CHIP	100nF,+80-20%,25V,Y5V,TP,1608,	
C330	2203-000189	C-CERAMIC,CHIP	100nF,+80-20%,25V,Y5V,TP,1608,	



Loc. No.	Code No.	Description	Specification	Remarks
C332	2203-000972	C-CERAMIC,CHIP	47nF,10%,16V,X7R,TP,1608	
C333	2203-000972	C-CERAMIC,CHIP	47nF,10%,16V,X7R,TP,1608	
C334	2203-000972	C-CERAMIC,CHIP	47nF,10%,16V,X7R,TP,1608	
C335	2203-000189	C-CERAMIC,CHIP	100nF,+80-20%,25V,Y5V,TP,1608,	
C336	2203-000972	C-CERAMIC,CHIP	47nF,10%,16V,X7R,TP,1608	
C337	2203-000972	C-CERAMIC,CHIP	47nF,10%,16V,X7R,TP,1608	
C339	2203-000784	C-CERAMIC,CHIP	0.33nF,5%,50V,NPO,TP,2012	
C34	2402-001155	C-AL,SMD	47UF,20%,16V,WT,TP,6.3X5.2MM	
C340	2203-000784	C-CERAMIC,CHIP	0.33nF,5%,50V,NPO,TP,2012	
C341	2203-000784	C-CERAMIC,CHIP	0.33nF,5%,50V,NPO,TP,2012	
C342	2203-000784	C-CERAMIC,CHIP	0.33nF,5%,50V,NPO,TP,2012	
C343	2203-000784	C-CERAMIC,CHIP	0.33nF,5%,50V,NPO,TP,2012	
C344	2203-000784	C-CERAMIC,CHIP	0.33nF,5%,50V,NPO,TP,2012	
C345	2402-000176	C-AL,SMD	10uF,20%,16V,GP,TP,4.3x4.3x5.4	
C346	2203-000189	C-CERAMIC,CHIP	100nF,+80-20%,25V,Y5V,TP,1608,	
C347	2203-000189	C-CERAMIC,CHIP	100nF,+80-20%,25V,Y5V,TP,1608,	
C348	2409-001029	C-ORGANIC	120uF,20%,6.3V,WT,TP,10.3x10.3x10.3mm,9	
C349	2203-000257	C-CERAMIC,CHIP	10nF,10%,50V,X7R,TP,1608	
C350	2203-000257	C-CERAMIC,CHIP	10nF,10%,50V,X7R,TP,1608	
C351	2203-000257	C-CERAMIC,CHIP	10nF,10%,50V,X7R,TP,1608	
C352	2203-001656	C-CERAMIC,CHIP	0.47nF,5%,50V,NPO,TP,1608	
C353	2203-000257	C-CERAMIC,CHIP	10nF,10%,50V,X7R,TP,1608	
C354	2402-001155	C-AL,SMD	47UF,20%,16V,WT,TP,6.3X5.2MM	
C355	2402-001155	C-AL,SMD	47UF,20%,16V,WT,TP,6.3X5.2MM	
C356	2402-001155	C-AL,SMD	47UF,20%,16V,WT,TP,6.3X5.2MM	
C36	2402-000170	C-AL,SMD	1uF,20%,50V,GP,TP,4.3x4.3x5.4,	
C37	2203-000189	C-CERAMIC,CHIP	100nF,+80-20%,25V,Y5V,TP,1608,	
C370	2402-001155	C-AL,SMD	47UF,20%,16V,WT,TP,6.3X5.2MM	
C371	2402-001155	C-AL,SMD	47UF,20%,16V,WT,TP,6.3X5.2MM	
C372	2402-001155	C-AL,SMD	47UF,20%,16V,WT,TP,6.3X5.2MM	
C374	2203-000257	C-CERAMIC,CHIP	10nF,10%,50V,X7R,TP,1608	
C375	2203-000257	C-CERAMIC,CHIP	10nF,10%,50V,X7R,TP,1608	
C376	2203-000257	C-CERAMIC,CHIP	10nF,10%,50V,X7R,TP,1608	
C38	2203-000189	C-CERAMIC,CHIP	100nF,+80-20%,25V,Y5V,TP,1608,	
C4	2402-000176	C-AL,SMD	10uF,20%,16V,GP,TP,4.3x4.3x5.4	
C40	2203-000189	C-CERAMIC,CHIP	100nF,+80-20%,25V,Y5V,TP,1608,	
C401	2409-001035	C-ORGANIC	10uF,20%,10V,LZ,TP,5.4x4.3x4.3mm,1	
C402	2409-001035	C-ORGANIC	10uF,20%,10V,LZ,TP,5.4x4.3x4.3mm,1	
C403	2402-000176	C-AL,SMD	10uF,20%,16V,GP,TP,4.3x4.3x5.4	
C404	2203-005005	C-CERAMIC,CHIP	100nF,10%,16V,X7R,TP,1608	
C405	2203-005005	C-CERAMIC,CHIP	100nF,10%,16V,X7R,TP,1608	
C406	2203-005005	C-CERAMIC,CHIP	100nF,10%,16V,X7R,TP,1608	
C407	2203-005005	C-CERAMIC,CHIP	100nF,10%,16V,X7R,TP,1608	
C408	2203-005005	C-CERAMIC,CHIP	100nF,10%,16V,X7R,TP,1608	
C409	2203-005005	C-CERAMIC,CHIP	100nF,10%,16V,X7R,TP,1608	
C41	2203-000189	C-CERAMIC,CHIP	100nF,+80-20%,25V,Y5V,TP,1608,	
C410	2203-005005	C-CERAMIC,CHIP	100nF,10%,16V,X7R,TP,1608	
C411	2203-005005	C-CERAMIC,CHIP	100nF,10%,16V,X7R,TP,1608	
C412	2203-005005	C-CERAMIC,CHIP	100nF,10%,16V,X7R,TP,1608	
C413	2203-005005	C-CERAMIC,CHIP	100nF,10%,16V,X7R,TP,1608	
C414	2203-005005	C-CERAMIC,CHIP	100nF,10%,16V,X7R,TP,1608	
C415	2203-005005	C-CERAMIC,CHIP	100nF,10%,16V,X7R,TP,1608	
C416	2203-005005	C-CERAMIC,CHIP	100nF,10%,16V,X7R,TP,1608	
C417	2203-005005	C-CERAMIC,CHIP	100nF,10%,16V,X7R,TP,1608	
C418	2203-005005	C-CERAMIC,CHIP	100nF,10%,16V,X7R,TP,1608	
C419	2203-005005	C-CERAMIC,CHIP	100nF,10%,16V,X7R,TP,1608	
C420	2203-005005	C-CERAMIC,CHIP	100nF,10%,16V,X7R,TP,1608	
C421	2203-005005	C-CERAMIC,CHIP	100nF,10%,16V,X7R,TP,1608	
C422	2203-005005	C-CERAMIC,CHIP	100nF,10%,16V,X7R,TP,1608	
C423	2203-000189	C-CERAMIC,CHIP	100nF,+80-20%,25V,Y5V,TP,1608,	
C424	2203-000189	C-CERAMIC,CHIP	100nF,+80-20%,25V,Y5V,TP,1608,	
C425	2402-000108	C-AL,SMD	10uF,20%,16V,WT,TP,4.3x4.3x5.4	
C426	2203-000440	C-CERAMIC,CHIP	1nF,10%,50V,X7R,TP,1608,-	
C427	2203-000440	C-CERAMIC,CHIP	1nF,10%,50V,X7R,TP,1608,-	
C428	2409-001029	C-ORGANIC	120uF,20%,6.3V,WT,TP,10.3x10.3x10.3mm,9	
C429	2203-000257	C-CERAMIC,CHIP	10nF,10%,50V,X7R,TP,1608	
C43	2203-000189	C-CERAMIC,CHIP	100nF,+80-20%,25V,Y5V,TP,1608,	
C430	2203-005005	C-CERAMIC,CHIP	100nF,10%,16V,X7R,TP,1608	
C431	2203-000257	C-CERAMIC,CHIP	10nF,10%,50V,X7R,TP,1608	
C432	2203-000257	C-CERAMIC,CHIP	10nF,10%,50V,X7R,TP,1608	

Loc. No.	Code No.	Description	Specification	Remarks
C433	2203-001656	C-CERAMIC,CHIP	0.47nF,5%,50V,NP0,TP,1608	
C434	2203-000257	C-CERAMIC,CHIP	10nF,10%,50V,X7R,TP,1608	
C435	2402-001155	C-AL,SMD	47UF,20%,16V,WT,TP,6.3X5.2MM	
C436	2402-001155	C-AL,SMD	47UF,20%,16V,WT,TP,6.3X5.2MM	
C437	2402-001155	C-AL,SMD	47UF,20%,16V,WT,TP,6.3X5.2MM	
C438	2203-000440	C-CERAMIC,CHIP	1nF,10%,50V,X7R,TP,1608,-	
C439	2203-000440	C-CERAMIC,CHIP	1nF,10%,50V,X7R,TP,1608,-	
C440	2203-000440	C-CERAMIC,CHIP	1nF,10%,50V,X7R,TP,1608,-	
C441	2203-000440	C-CERAMIC,CHIP	1nF,10%,50V,X7R,TP,1608,-	
C442	2203-000903	C-CERAMIC,CHIP	0.0047nF,0.25pF,50V,NP0,TP,1608	
C443	2203-000903	C-CERAMIC,CHIP	0.0047nF,0.25pF,50V,NP0,TP,1608	
C444	2203-000903	C-CERAMIC,CHIP	0.0047nF,0.25pF,50V,NP0,TP,1608	
C445	2402-001155	C-AL,SMD	47UF,20%,16V,WT,TP,6.3X5.2MM	
C446	2402-001155	C-AL,SMD	47UF,20%,16V,WT,TP,6.3X5.2MM	
C447	2402-001155	C-AL,SMD	47UF,20%,16V,WT,TP,6.3X5.2MM	
C448	2203-000257	C-CERAMIC,CHIP	10nF,10%,50V,X7R,TP,1608	
C449	2203-000257	C-CERAMIC,CHIP	10nF,10%,50V,X7R,TP,1608	
C45	2203-000189	C-CERAMIC,CHIP	100nF,+80-20%,25V,Y5V,TP,1608,	
C450	2203-000257	C-CERAMIC,CHIP	10nF,10%,50V,X7R,TP,1608	
C451	2203-005005	C-CERAMIC,CHIP	100nF,10%,16V,X7R,TP,1608	
C452	2203-000843	C-CERAMIC,CHIP	39nF,10%,25V,X7R,TP,1608,-	
C453	2203-000726	C-CERAMIC,CHIP	3.9nF,10%,50V,X7R,TP,1608,-	
C454	2203-000189	C-CERAMIC,CHIP	100nF,+80-20%,25V,Y5V,TP,1608,	
C455	2203-000189	C-CERAMIC,CHIP	100nF,+80-20%,25V,Y5V,TP,1608,	
C48	2402-000176	C-AL,SMD	10uF,20%,16V,GP,TP,4.3x4.3x5.4	
C49	2402-001155	C-AL,SMD	47UF,20%,16V,WT,TP,6.3X5.2MM	
C5	2402-000176	C-AL,SMD	10uF,20%,16V,GP,TP,4.3x4.3x5.4	
C501	2203-000189	C-CERAMIC,CHIP	100nF,+80-20%,25V,Y5V,TP,1608,	
C502	2402-000144	C-AL,SMD	3.3uF,20%,50V,GP,TP,4.3x4.3x5.	
C503	2402-000176	C-AL,SMD	10uF,20%,16V,GP,TP,4.3x4.3x5.4	
C504	2203-000189	C-CERAMIC,CHIP	100nF,+80-20%,25V,Y5V,TP,1608,	
C505	2203-001656	C-CERAMIC,CHIP	0.47nF,5%,50V,NP0,TP,1608	
C506	2203-000140	C-CERAMIC,CHIP	1.5nF,10%,50V,X7R,TP,1608,-	
C507	2402-001042	C-AL,SMD	100uF,20%,16V,GP,TP,6.6x6.6x5.4mm	
C508	2402-001155	C-AL,SMD	47UF,20%,16V,WT,TP,6.3X5.2MM	
C509	2402-001044	C-AL,SMD	100UF,20%,25V,GP,TP,8.3X8.3X6.3MM	
C51	2203-000189	C-CERAMIC,CHIP	100nF,+80-20%,25V,Y5V,TP,1608,	
C510	2203-005005	C-CERAMIC,CHIP	100nF,10%,16V,X7R,TP,1608	
C511	2402-001044	C-AL,SMD	100UF,20%,25V,GP,TP,8.3X8.3X6.3MM	
C512	2203-000257	C-CERAMIC,CHIP	10nF,10%,50V,X7R,TP,1608	
C513	2402-001044	C-AL,SMD	100UF,20%,25V,GP,TP,8.3X8.3X6.3MM	
C514	2203-000257	C-CERAMIC,CHIP	10nF,10%,50V,X7R,TP,1608	
C515	2402-000176	C-AL,SMD	10uF,20%,16V,GP,TP,4.3x4.3x5.4	
C516	2203-005005	C-CERAMIC,CHIP	100nF,10%,16V,X7R,TP,1608	
C517	2203-000140	C-CERAMIC,CHIP	1.5nF,10%,50V,X7R,TP,1608,-	
C518	2203-001656	C-CERAMIC,CHIP	0.47nF,5%,50V,NP0,TP,1608	
C519	2402-000176	C-AL,SMD	10uF,20%,16V,GP,TP,4.3x4.3x5.4	
C52	2203-000626	C-CERAMIC,CHIP	0.022nF,5%,50V,NP0,TP,1608	
C520	2402-000176	C-AL,SMD	10uF,20%,16V,GP,TP,4.3x4.3x5.4	
C521	2203-001077	C-CERAMIC,CHIP	0.056nF,5%,50V,NP0,TP,2012	
C522	2402-000176	C-AL,SMD	10uF,20%,16V,GP,TP,4.3x4.3x5.4	
C523	2203-001077	C-CERAMIC,CHIP	0.056nF,5%,50V,NP0,TP,2012	
C524	2402-000209	C-AL,SMD	22uF,20%,16V,WT,TP,5.3x5.3mm,1	
C525	2203-001077	C-CERAMIC,CHIP	0.056nF,5%,50V,NP0,TP,2012	
C526	2402-000209	C-AL,SMD	22uF,20%,16V,WT,TP,5.3x5.3mm,1	
C527	2402-000170	C-AL,SMD	1uF,20%,50V,GP,TP,4.3x4.3x5.4,	
C528	2203-000189	C-CERAMIC,CHIP	100nF,+80-20%,25V,Y5V,TP,1608,	
C529	2203-005015	C-CERAMIC,CHIP	150nF,+80-20%,16V,Y5V,TP,1608	
C53	2203-000626	C-CERAMIC,CHIP	0.022nF,5%,50V,NP0,TP,1608	
C530	2203-005015	C-CERAMIC,CHIP	150nF,+80-20%,16V,Y5V,TP,1608	
C531	2203-005015	C-CERAMIC,CHIP	150nF,+80-20%,16V,Y5V,TP,1608	
C532	2203-005015	C-CERAMIC,CHIP	150nF,+80-20%,16V,Y5V,TP,1608	
C533	2203-000189	C-CERAMIC,CHIP	100nF,+80-20%,25V,Y5V,TP,1608,	
C534	2402-001044	C-AL,SMD	100UF,20%,25V,GP,TP,8.3X8.3X6.3MM	
C535	2402-000170	C-AL,SMD	1uF,20%,50V,GP,TP,4.3x4.3x5.4,	
C536	2203-000701	C-CERAMIC,CHIP	0.002nF,0.25pF,50V,NP0,TP,2012	
C537	2203-000701	C-CERAMIC,CHIP	0.002nF,0.25pF,50V,NP0,TP,2012	
C538	2203-000903	C-CERAMIC,CHIP	0.0047nF,0.25pF,50V,NP0,TP,1608	
C539	2203-000903	C-CERAMIC,CHIP	0.0047nF,0.25pF,50V,NP0,TP,1608	
C54	2203-000626	C-CERAMIC,CHIP	0.022nF,5%,50V,NP0,TP,1608	

Loc. No.	Code No.	Description	Specification	Remarks
C540	2203-005015	C-CERAMIC,CHIP	150nF,+80-20%,16V,Y5V,TP,1608	
C541	2203-005015	C-CERAMIC,CHIP	150nF,+80-20%,16V,Y5V,TP,1608	
C542	2203-005015	C-CERAMIC,CHIP	150nF,+80-20%,16V,Y5V,TP,1608	
C543	2402-000170	C-AL,SMD	1uF,20%,50V,GP,TP,4.3x4.3x5.4,	
C544	2203-000440	C-CERAMIC,CHIP	1nF,10%,50V,X7R,TP,1608,-	
C545	2402-000173	C-AL,SMD	4.7uF,20%,35V,GP,TP,4.3x4.3x5.	
C546	2402-000173	C-AL,SMD	4.7uF,20%,35V,GP,TP,4.3x4.3x5.	
C547	2203-005015	C-CERAMIC,CHIP	150nF,+80-20%,16V,Y5V,TP,1608	
C548	2203-005015	C-CERAMIC,CHIP	150nF,+80-20%,16V,Y5V,TP,1608	
C549	2203-005015	C-CERAMIC,CHIP	150nF,+80-20%,16V,Y5V,TP,1608	
C55	2203-000626	C-CERAMIC,CHIP	0.022nF,5%,50V,NPO,TP,1608	
C550	2203-005015	C-CERAMIC,CHIP	150nF,+80-20%,16V,Y5V,TP,1608	
C551	2203-000189	C-CERAMIC,CHIP	100nF,+80-20%,25V,Y5V,TP,1608,	
C552	2203-000440	C-CERAMIC,CHIP	1nF,10%,50V,X7R,TP,1608,-	
C553	2203-000440	C-CERAMIC,CHIP	1nF,10%,50V,X7R,TP,1608,-	
C554	2203-000189	C-CERAMIC,CHIP	100nF,+80-20%,25V,Y5V,TP,1608,	
C556	2203-005015	C-CERAMIC,CHIP	150nF,+80-20%,16V,Y5V,TP,1608	
C557	2203-005015	C-CERAMIC,CHIP	150nF,+80-20%,16V,Y5V,TP,1608	
C558	2203-005015	C-CERAMIC,CHIP	150nF,+80-20%,16V,Y5V,TP,1608	
C559	2203-005189	C-CERAMIC,CHIP	680nF,+80-20%,16V,Y5V,TP,2012,	
C56	2402-000176	C-AL,SMD	10uF,20%,16V,GP,TP,4.3x4.3x5.4	
C560	2203-005189	C-CERAMIC,CHIP	680nF,+80-20%,16V,Y5V,TP,2012,	
C561	2203-000716	C-CERAMIC,CHIP	3.3nF,10%,50V,X7R,TP,2012,-	
C562	2203-000716	C-CERAMIC,CHIP	3.3nF,10%,50V,X7R,TP,2012,-	
C563	2402-000176	C-AL,SMD	10uF,20%,16V,GP,TP,4.3x4.3x5.4	
C564	2203-000189	C-CERAMIC,CHIP	100nF,+80-20%,25V,Y5V,TP,1608,	
C565	2203-001656	C-CERAMIC,CHIP	0.47nF,5%,50V,NPO,TP,1608	
C566	2402-000176	C-AL,SMD	10uF,20%,16V,GP,TP,4.3x4.3x5.4	
C567	2203-000140	C-CERAMIC,CHIP	1.5nF,10%,50V,X7R,TP,1608,-	
C568	2203-000972	C-CERAMIC,CHIP	47nF,10%,16V,X7R,TP,1608	
C569	2203-001607	C-CERAMIC,CHIP	0.22nF,5%,50V,NPO,TP,1608	
C57	2402-000176	C-AL,SMD	10uF,20%,16V,GP,TP,4.3x4.3x5.4	
C570	2203-000972	C-CERAMIC,CHIP	47nF,10%,16V,X7R,TP,1608	
C571	2402-001044	C-AL,SMD	100UF,20%,25V,GP,TP,8.3X8.3X6.3MM	
C572	2402-001006	C-AL,SMD	4.7uF,20%,25V,GP,TP,3.6x6.3x3.	
C573	2402-001006	C-AL,SMD	4.7uF,20%,25V,GP,TP,3.6x6.3x3.	
C574	2402-001044	C-AL,SMD	100UF,20%,25V,GP,TP,8.3X8.3X6.3MM	
C575	2402-001042	C-AL,SMD	100uF,20%,16V,GP,TP,6.6x6.6x5.4mm	
C576	2203-000204	C-CERAMIC,CHIP	100nF,10%,25V,X7R,TP,2012	
C577	2203-000784	C-CERAMIC,CHIP	0.33nF,5%,50V,NPO,TP,2012	
C578	2203-000140	C-CERAMIC,CHIP	1.5nF,10%,50V,X7R,TP,1608,-	
C579	2203-000140	C-CERAMIC,CHIP	1.5nF,10%,50V,X7R,TP,1608,-	
C58	2203-000189	C-CERAMIC,CHIP	100nF,+80-20%,25V,Y5V,TP,1608,	
C580	2402-001006	C-AL,SMD	4.7uF,20%,25V,GP,TP,3.6x6.3x3.	
C581	2402-001006	C-AL,SMD	4.7uF,20%,25V,GP,TP,3.6x6.3x3.	
C582	2203-000204	C-CERAMIC,CHIP	100nF,10%,25V,X7R,TP,2012	
C583	2203-000784	C-CERAMIC,CHIP	0.33nF,5%,50V,NPO,TP,2012	
C584	2402-001006	C-AL,SMD	4.7uF,20%,25V,GP,TP,3.6x6.3x3.	
C585	2402-001006	C-AL,SMD	4.7uF,20%,25V,GP,TP,3.6x6.3x3.	
C586	2203-000784	C-CERAMIC,CHIP	0.33nF,5%,50V,NPO,TP,2012	
C587	2203-000784	C-CERAMIC,CHIP	0.33nF,5%,50V,NPO,TP,2012	
C588	2402-001006	C-AL,SMD	4.7uF,20%,25V,GP,TP,3.6x6.3x3.	
C589	2402-001006	C-AL,SMD	4.7uF,20%,25V,GP,TP,3.6x6.3x3.	
C59	2203-000189	C-CERAMIC,CHIP	100nF,+80-20%,25V,Y5V,TP,1608,	
C590	2203-000784	C-CERAMIC,CHIP	0.33nF,5%,50V,NPO,TP,2012	
C591	2203-000784	C-CERAMIC,CHIP	0.33nF,5%,50V,NPO,TP,2012	
C6	2402-000176	C-AL,SMD	10uF,20%,16V,GP,TP,4.3x4.3x5.4	
C60	2203-000189	C-CERAMIC,CHIP	100nF,+80-20%,25V,Y5V,TP,1608,	
C601	2203-000440	C-CERAMIC,CHIP	1nF,10%,50V,X7R,TP,1608,-	
C602	2203-000440	C-CERAMIC,CHIP	1nF,10%,50V,X7R,TP,1608,-	
C603	2203-000440	C-CERAMIC,CHIP	1nF,10%,50V,X7R,TP,1608,-	
C604	2203-000440	C-CERAMIC,CHIP	1nF,10%,50V,X7R,TP,1608,-	
C605	2203-000440	C-CERAMIC,CHIP	1nF,10%,50V,X7R,TP,1608,-	
C606	2203-000440	C-CERAMIC,CHIP	1nF,10%,50V,X7R,TP,1608,-	
C607	2203-000440	C-CERAMIC,CHIP	1nF,10%,50V,X7R,TP,1608,-	
C608	2203-000440	C-CERAMIC,CHIP	1nF,10%,50V,X7R,TP,1608,-	
C609	2203-000440	C-CERAMIC,CHIP	1nF,10%,50V,X7R,TP,1608,-	
C61	2203-000189	C-CERAMIC,CHIP	100nF,+80-20%,25V,Y5V,TP,1608,	
C610	2203-000440	C-CERAMIC,CHIP	1nF,10%,50V,X7R,TP,1608,-	
C611	2203-000440	C-CERAMIC,CHIP	1nF,10%,50V,X7R,TP,1608,-	

Loc. No.	Code No.	Description	Specification	Remarks
C612	2203-000189	C-CERAMIC,CHIP	100nF,+80-20%,25V,Y5V,TP,1608,	
C613	2203-000189	C-CERAMIC,CHIP	100nF,+80-20%,25V,Y5V,TP,1608,	
C614	2203-000189	C-CERAMIC,CHIP	100nF,+80-20%,25V,Y5V,TP,1608,	
C615	2203-000189	C-CERAMIC,CHIP	100nF,+80-20%,25V,Y5V,TP,1608,	
C616	2203-000189	C-CERAMIC,CHIP	100nF,+80-20%,25V,Y5V,TP,1608,	
C617	2203-000189	C-CERAMIC,CHIP	100nF,+80-20%,25V,Y5V,TP,1608,	
C618	2203-000189	C-CERAMIC,CHIP	100nF,+80-20%,25V,Y5V,TP,1608,	
C619	2203-000189	C-CERAMIC,CHIP	100nF,+80-20%,25V,Y5V,TP,1608,	
C62	2203-000189	C-CERAMIC,CHIP	100nF,+80-20%,25V,Y5V,TP,1608,	
C620	2203-000189	C-CERAMIC,CHIP	100nF,+80-20%,25V,Y5V,TP,1608,	
C621	2203-000189	C-CERAMIC,CHIP	100nF,+80-20%,25V,Y5V,TP,1608,	
C622	2203-000189	C-CERAMIC,CHIP	100nF,+80-20%,25V,Y5V,TP,1608,	
C623	2402-000209	C-AL,SMD	22uF,20%,16V,WT,TP,5.3x5.3mm,1	
C624	2402-000209	C-AL,SMD	22uF,20%,16V,WT,TP,5.3x5.3mm,1	
C625	2203-000189	C-CERAMIC,CHIP	100nF,+80-20%,25V,Y5V,TP,1608,	
C626	2203-000189	C-CERAMIC,CHIP	100nF,+80-20%,25V,Y5V,TP,1608,	
C627	2203-000189	C-CERAMIC,CHIP	100nF,+80-20%,25V,Y5V,TP,1608,	
C628	2203-000189	C-CERAMIC,CHIP	100nF,+80-20%,25V,Y5V,TP,1608,	
C629	2203-000189	C-CERAMIC,CHIP	100nF,+80-20%,25V,Y5V,TP,1608,	
C63	2203-000189	C-CERAMIC,CHIP	100nF,+80-20%,25V,Y5V,TP,1608,	
C630	2203-000189	C-CERAMIC,CHIP	100nF,+80-20%,25V,Y5V,TP,1608,	
C631	2203-000189	C-CERAMIC,CHIP	100nF,+80-20%,25V,Y5V,TP,1608,	
C632	2203-000189	C-CERAMIC,CHIP	100nF,+80-20%,25V,Y5V,TP,1608,	
C633	2203-000189	C-CERAMIC,CHIP	100nF,+80-20%,25V,Y5V,TP,1608,	
C634	2203-000189	C-CERAMIC,CHIP	100nF,+80-20%,25V,Y5V,TP,1608,	
C635	2203-000189	C-CERAMIC,CHIP	100nF,+80-20%,25V,Y5V,TP,1608,	
C636	2203-000189	C-CERAMIC,CHIP	100nF,+80-20%,25V,Y5V,TP,1608,	
C637	2402-000209	C-AL,SMD	22uF,20%,16V,WT,TP,5.3x5.3mm,1	
C638	2203-000189	C-CERAMIC,CHIP	100nF,+80-20%,25V,Y5V,TP,1608,	
C639	2203-000189	C-CERAMIC,CHIP	100nF,+80-20%,25V,Y5V,TP,1608,	
C64	2402-001155	C-AL,SMD	47UF,20%,16V,WT,TP,6.3X5.2MM	
C640	2203-000189	C-CERAMIC,CHIP	100nF,+80-20%,25V,Y5V,TP,1608,	
C641	2203-000189	C-CERAMIC,CHIP	100nF,+80-20%,25V,Y5V,TP,1608,	
C642	2203-000189	C-CERAMIC,CHIP	100nF,+80-20%,25V,Y5V,TP,1608,	
C643	2203-000189	C-CERAMIC,CHIP	100nF,+80-20%,25V,Y5V,TP,1608,	
C644	2203-000189	C-CERAMIC,CHIP	100nF,+80-20%,25V,Y5V,TP,1608,	
C645	2203-000189	C-CERAMIC,CHIP	100nF,+80-20%,25V,Y5V,TP,1608,	
C646	2203-000189	C-CERAMIC,CHIP	100nF,+80-20%,25V,Y5V,TP,1608,	
C647	2203-000189	C-CERAMIC,CHIP	100nF,+80-20%,25V,Y5V,TP,1608,	
C648	2203-000189	C-CERAMIC,CHIP	100nF,+80-20%,25V,Y5V,TP,1608,	
C649	2203-000189	C-CERAMIC,CHIP	100nF,+80-20%,25V,Y5V,TP,1608,	
C65	2402-001155	C-AL,SMD	47UF,20%,16V,WT,TP,6.3X5.2MM	
C650	2203-000440	C-CERAMIC,CHIP	1nF,10%,50V,X7R,TP,1608,-	
C651	2203-000440	C-CERAMIC,CHIP	1nF,10%,50V,X7R,TP,1608,-	
C652	2203-000440	C-CERAMIC,CHIP	1nF,10%,50V,X7R,TP,1608,-	
C653	2203-000440	C-CERAMIC,CHIP	1nF,10%,50V,X7R,TP,1608,-	
C654	2203-000189	C-CERAMIC,CHIP	100nF,+80-20%,25V,Y5V,TP,1608,	
C655	2203-000189	C-CERAMIC,CHIP	100nF,+80-20%,25V,Y5V,TP,1608,	
C656	2203-000189	C-CERAMIC,CHIP	100nF,+80-20%,25V,Y5V,TP,1608,	
C657	2203-000189	C-CERAMIC,CHIP	100nF,+80-20%,25V,Y5V,TP,1608,	
C658	2203-000189	C-CERAMIC,CHIP	100nF,+80-20%,25V,Y5V,TP,1608,	
C659	2203-000189	C-CERAMIC,CHIP	100nF,+80-20%,25V,Y5V,TP,1608,	
C66	2203-000236	C-CERAMIC,CHIP	0.1nF,5%,50V,NPO,TP,1608	
C660	2203-000189	C-CERAMIC,CHIP	100nF,+80-20%,25V,Y5V,TP,1608,	
C661	2203-000189	C-CERAMIC,CHIP	100nF,+80-20%,25V,Y5V,TP,1608,	
C662	2203-000189	C-CERAMIC,CHIP	100nF,+80-20%,25V,Y5V,TP,1608,	
C663	2203-000189	C-CERAMIC,CHIP	100nF,+80-20%,25V,Y5V,TP,1608,	
C664	2203-000189	C-CERAMIC,CHIP	100nF,+80-20%,25V,Y5V,TP,1608,	
C665	2203-000189	C-CERAMIC,CHIP	100nF,+80-20%,25V,Y5V,TP,1608,	
C666	2402-000209	C-AL,SMD	22uF,20%,16V,WT,TP,5.3x5.3mm,1	
C667	2409-001035	C-ORGANIC	10uF,20%,10V,LZ,TP,5.4x4.3x4.3mm,1	
C668	2203-000189	C-CERAMIC,CHIP	100nF,+80-20%,25V,Y5V,TP,1608,	
C669	2203-000189	C-CERAMIC,CHIP	100nF,+80-20%,25V,Y5V,TP,1608,	
C67	2203-000236	C-CERAMIC,CHIP	0.1nF,5%,50V,NPO,TP,1608	
C670	2203-000189	C-CERAMIC,CHIP	100nF,+80-20%,25V,Y5V,TP,1608,	
C671	2203-000384	C-CERAMIC,CHIP	0.015nF,5%,50V,NPO,TP,1608	
C672	2203-005065	C-CERAMIC,CHIP	1000nF,+80-20%,10V,Y5V,TP,1608	
C673	2203-005065	C-CERAMIC,CHIP	1000nF,+80-20%,10V,Y5V,TP,1608	
C674	2203-005065	C-CERAMIC,CHIP	1000nF,+80-20%,10V,Y5V,TP,1608	
C675	2203-005065	C-CERAMIC,CHIP	1000nF,+80-20%,10V,Y5V,TP,1608	

Loc. No.	Code No.	Description	Specification	Remarks
C676	2203-005065	C-CERAMIC,CHIP	100nF,+80-20%,10V,Y5V,TP,1608	
C677	2203-005065	C-CERAMIC,CHIP	100nF,+80-20%,10V,Y5V,TP,1608	
C678	2203-000189	C-CERAMIC,CHIP	100nF,+80-20%,25V,Y5V,TP,1608,	
C679	2203-000280	C-CERAMIC,CHIP	0.01nF,0.5pF,50V,NPO,TP,1608	
C68	2203-000189	C-CERAMIC,CHIP	100nF,+80-20%,25V,Y5V,TP,1608,	
C69	2402-001044	C-AL,SMD	100UF,20%,25V,GP,TP,8.3X8.3X6.3MM	
C7	2203-000189	C-CERAMIC,CHIP	100nF,+80-20%,25V,Y5V,TP,1608,	
C70	2402-000176	C-AL,SMD	10uF,20%,16V,GP,TP,4.3x4.3x5.4	
C701	2402-000209	C-AL,SMD	22uF,20%,16V,WT,TP,5.3x5.3mm,1	
C702	2203-000189	C-CERAMIC,CHIP	100nF,+80-20%,25V,Y5V,TP,1608,	
C703	2203-000189	C-CERAMIC,CHIP	100nF,+80-20%,25V,Y5V,TP,1608,	
C704	2203-000189	C-CERAMIC,CHIP	100nF,+80-20%,25V,Y5V,TP,1608,	
C705	2203-000189	C-CERAMIC,CHIP	100nF,+80-20%,25V,Y5V,TP,1608,	
C706	2203-000189	C-CERAMIC,CHIP	100nF,+80-20%,25V,Y5V,TP,1608,	
C707	2402-000209	C-AL,SMD	22uF,20%,16V,WT,TP,5.3x5.3mm,1	
C708	2203-000189	C-CERAMIC,CHIP	100nF,+80-20%,25V,Y5V,TP,1608,	
C709	2203-000189	C-CERAMIC,CHIP	100nF,+80-20%,25V,Y5V,TP,1608,	
C710	2203-000189	C-CERAMIC,CHIP	100nF,+80-20%,25V,Y5V,TP,1608,	
C711	2203-000189	C-CERAMIC,CHIP	100nF,+80-20%,25V,Y5V,TP,1608,	
C712	2203-000189	C-CERAMIC,CHIP	100nF,+80-20%,25V,Y5V,TP,1608,	
C713	2203-000189	C-CERAMIC,CHIP	100nF,+80-20%,25V,Y5V,TP,1608,	
C714	2203-000189	C-CERAMIC,CHIP	100nF,+80-20%,25V,Y5V,TP,1608,	
C715	2203-000189	C-CERAMIC,CHIP	100nF,+80-20%,25V,Y5V,TP,1608,	
C716	2203-000384	C-CERAMIC,CHIP	0.015nF,5%,50V,NPO,TP,1608	
C717	2203-000384	C-CERAMIC,CHIP	0.015nF,5%,50V,NPO,TP,1608	
C718	2203-000384	C-CERAMIC,CHIP	0.015nF,5%,50V,NPO,TP,1608	
C719	2203-000189	C-CERAMIC,CHIP	100nF,+80-20%,25V,Y5V,TP,1608,	
C720	2203-000626	C-CERAMIC,CHIP	0.022nF,5%,50V,NPO,TP,1608	
C721	2203-001222	C-CERAMIC,CHIP	820pF,10%,50V,X7R,TP,1608,-	
C722	2203-001222	C-CERAMIC,CHIP	820pF,10%,50V,X7R,TP,1608,-	
C723	2402-000209	C-AL,SMD	22uF,20%,16V,WT,TP,5.3x5.3mm,1	
C724	2203-000189	C-CERAMIC,CHIP	100nF,+80-20%,25V,Y5V,TP,1608,	
C725	2203-000189	C-CERAMIC,CHIP	100nF,+80-20%,25V,Y5V,TP,1608,	
C726	2203-000189	C-CERAMIC,CHIP	100nF,+80-20%,25V,Y5V,TP,1608,	
C727	2203-000189	C-CERAMIC,CHIP	100nF,+80-20%,25V,Y5V,TP,1608,	
C728	2203-000189	C-CERAMIC,CHIP	100nF,+80-20%,25V,Y5V,TP,1608,	
C729	2203-000189	C-CERAMIC,CHIP	100nF,+80-20%,25V,Y5V,TP,1608,	
C730	2203-000189	C-CERAMIC,CHIP	100nF,+80-20%,25V,Y5V,TP,1608,	
C731	2203-000189	C-CERAMIC,CHIP	100nF,+80-20%,25V,Y5V,TP,1608,	
C732	2203-000189	C-CERAMIC,CHIP	100nF,+80-20%,25V,Y5V,TP,1608,	
C733	2203-000189	C-CERAMIC,CHIP	100nF,+80-20%,25V,Y5V,TP,1608,	
C734	2203-000189	C-CERAMIC,CHIP	100nF,+80-20%,25V,Y5V,TP,1608,	
C735	2203-000189	C-CERAMIC,CHIP	100nF,+80-20%,25V,Y5V,TP,1608,	
C736	2203-000384	C-CERAMIC,CHIP	0.015nF,5%,50V,NPO,TP,1608	
C8	2203-000189	C-CERAMIC,CHIP	100nF,+80-20%,25V,Y5V,TP,1608,	
C801	2203-000440	C-CERAMIC,CHIP	1nF,10%,50V,X7R,TP,1608,-	
C802	2203-000440	C-CERAMIC,CHIP	1nF,10%,50V,X7R,TP,1608,-	
C803	2203-000440	C-CERAMIC,CHIP	1nF,10%,50V,X7R,TP,1608,-	
C804	2203-000440	C-CERAMIC,CHIP	1nF,10%,50V,X7R,TP,1608,-	
C805	2203-000440	C-CERAMIC,CHIP	1nF,10%,50V,X7R,TP,1608,-	
C806	2203-000440	C-CERAMIC,CHIP	1nF,10%,50V,X7R,TP,1608,-	
C807	2203-000440	C-CERAMIC,CHIP	1nF,10%,50V,X7R,TP,1608,-	
C808	2203-000440	C-CERAMIC,CHIP	1nF,10%,50V,X7R,TP,1608,-	
C809	2203-000440	C-CERAMIC,CHIP	1nF,10%,50V,X7R,TP,1608,-	
C810	2203-000440	C-CERAMIC,CHIP	1nF,10%,50V,X7R,TP,1608,-	
C811	2203-000440	C-CERAMIC,CHIP	1nF,10%,50V,X7R,TP,1608,-	
C812	2203-000189	C-CERAMIC,CHIP	100nF,+80-20%,25V,Y5V,TP,1608,	
C813	2203-000189	C-CERAMIC,CHIP	100nF,+80-20%,25V,Y5V,TP,1608,	
C814	2203-000189	C-CERAMIC,CHIP	100nF,+80-20%,25V,Y5V,TP,1608,	
C815	2203-000189	C-CERAMIC,CHIP	100nF,+80-20%,25V,Y5V,TP,1608,	
C816	2203-000189	C-CERAMIC,CHIP	100nF,+80-20%,25V,Y5V,TP,1608,	
C817	2203-000189	C-CERAMIC,CHIP	100nF,+80-20%,25V,Y5V,TP,1608,	
C818	2203-000189	C-CERAMIC,CHIP	100nF,+80-20%,25V,Y5V,TP,1608,	
C819	2203-000189	C-CERAMIC,CHIP	100nF,+80-20%,25V,Y5V,TP,1608,	
C820	2203-000189	C-CERAMIC,CHIP	100nF,+80-20%,25V,Y5V,TP,1608,	
C821	2203-000189	C-CERAMIC,CHIP	100nF,+80-20%,25V,Y5V,TP,1608,	
C822	2203-000189	C-CERAMIC,CHIP	100nF,+80-20%,25V,Y5V,TP,1608,	
C823	2402-000209	C-AL,SMD	22uF,20%,16V,WT,TP,5.3x5.3mm,1	
C824	2203-000440	C-CERAMIC,CHIP	1nF,10%,50V,X7R,TP,1608,-	
C825	2203-000440	C-CERAMIC,CHIP	1nF,10%,50V,X7R,TP,1608,-	

Loc. No.	Code No.	Description	Specification	Remarks
C826	2203-000440	C-CERAMIC,CHIP	1nF,10%,50V,X7R,TP,1608,-	
C827	2203-000440	C-CERAMIC,CHIP	1nF,10%,50V,X7R,TP,1608,-	
C828	2203-000189	C-CERAMIC,CHIP	100nF,+80-20%,25V,Y5V,TP,1608,	
C829	2203-000189	C-CERAMIC,CHIP	100nF,+80-20%,25V,Y5V,TP,1608,	
C830	2203-000189	C-CERAMIC,CHIP	100nF,+80-20%,25V,Y5V,TP,1608,	
C831	2203-000189	C-CERAMIC,CHIP	100nF,+80-20%,25V,Y5V,TP,1608,	
C832	2203-000189	C-CERAMIC,CHIP	100nF,+80-20%,25V,Y5V,TP,1608,	
C833	2203-000189	C-CERAMIC,CHIP	100nF,+80-20%,25V,Y5V,TP,1608,	
C834	2203-000189	C-CERAMIC,CHIP	100nF,+80-20%,25V,Y5V,TP,1608,	
C835	2203-000189	C-CERAMIC,CHIP	100nF,+80-20%,25V,Y5V,TP,1608,	
C836	2203-000189	C-CERAMIC,CHIP	100nF,+80-20%,25V,Y5V,TP,1608,	
C837	2203-000189	C-CERAMIC,CHIP	100nF,+80-20%,25V,Y5V,TP,1608,	
C838	2203-000189	C-CERAMIC,CHIP	100nF,+80-20%,25V,Y5V,TP,1608,	
C839	2203-000189	C-CERAMIC,CHIP	100nF,+80-20%,25V,Y5V,TP,1608,	
C840	2402-000209	C-AL,SMD	22uF,20%,16V,WT,TP,5.3x5.3mm,1	
C841	2409-001035	C-ORGANIC	10uF,20%,10V,LZ,TP,5.4x4.3x4.3mm,1	
C842	2203-000189	C-CERAMIC,CHIP	100nF,+80-20%,25V,Y5V,TP,1608,	
C843	2203-000189	C-CERAMIC,CHIP	100nF,+80-20%,25V,Y5V,TP,1608,	
C844	2203-000189	C-CERAMIC,CHIP	100nF,+80-20%,25V,Y5V,TP,1608,	
C845	2402-000209	C-AL,SMD	22uF,20%,16V,WT,TP,5.3x5.3mm,1	
C846	2203-000384	C-CERAMIC,CHIP	0.015nF,5%,50V,NPO,TP,1608	
C847	2402-000209	C-AL,SMD	22uF,20%,16V,WT,TP,5.3x5.3mm,1	
C848	2203-000189	C-CERAMIC,CHIP	100nF,+80-20%,25V,Y5V,TP,1608,	
C849	2203-000189	C-CERAMIC,CHIP	100nF,+80-20%,25V,Y5V,TP,1608,	
C850	2203-000189	C-CERAMIC,CHIP	100nF,+80-20%,25V,Y5V,TP,1608,	
C851	2203-000189	C-CERAMIC,CHIP	100nF,+80-20%,25V,Y5V,TP,1608,	
C852	2203-000189	C-CERAMIC,CHIP	100nF,+80-20%,25V,Y5V,TP,1608,	
C853	2203-000189	C-CERAMIC,CHIP	100nF,+80-20%,25V,Y5V,TP,1608,	
C854	2203-000189	C-CERAMIC,CHIP	100nF,+80-20%,25V,Y5V,TP,1608,	
C855	2203-000189	C-CERAMIC,CHIP	100nF,+80-20%,25V,Y5V,TP,1608,	
C856	2203-000189	C-CERAMIC,CHIP	100nF,+80-20%,25V,Y5V,TP,1608,	
C857	2203-000189	C-CERAMIC,CHIP	100nF,+80-20%,25V,Y5V,TP,1608,	
C858	2203-000189	C-CERAMIC,CHIP	100nF,+80-20%,25V,Y5V,TP,1608,	
C859	2203-000189	C-CERAMIC,CHIP	100nF,+80-20%,25V,Y5V,TP,1608,	
C860	2402-000209	C-AL,SMD	22uF,20%,16V,WT,TP,5.3x5.3mm,1	
C861	2203-000189	C-CERAMIC,CHIP	100nF,+80-20%,25V,Y5V,TP,1608,	
C862	2203-000189	C-CERAMIC,CHIP	100nF,+80-20%,25V,Y5V,TP,1608,	
C863	2203-000189	C-CERAMIC,CHIP	100nF,+80-20%,25V,Y5V,TP,1608,	
C864	2203-000189	C-CERAMIC,CHIP	100nF,+80-20%,25V,Y5V,TP,1608,	
C865	2203-000189	C-CERAMIC,CHIP	100nF,+80-20%,25V,Y5V,TP,1608,	
C866	2203-000189	C-CERAMIC,CHIP	100nF,+80-20%,25V,Y5V,TP,1608,	
C867	2203-000189	C-CERAMIC,CHIP	100nF,+80-20%,25V,Y5V,TP,1608,	
C868	2203-000189	C-CERAMIC,CHIP	100nF,+80-20%,25V,Y5V,TP,1608,	
C869	2203-000189	C-CERAMIC,CHIP	100nF,+80-20%,25V,Y5V,TP,1608,	
C870	2203-000189	C-CERAMIC,CHIP	100nF,+80-20%,25V,Y5V,TP,1608,	
C871	2203-000189	C-CERAMIC,CHIP	100nF,+80-20%,25V,Y5V,TP,1608,	
C872	2203-000189	C-CERAMIC,CHIP	100nF,+80-20%,25V,Y5V,TP,1608,	
C873	2203-000384	C-CERAMIC,CHIP	0.015nF,5%,50V,NPO,TP,1608	
C888	2203-000626	C-CERAMIC,CHIP	0.022nF,5%,50V,NPO,TP,1608	
C9	2203-000189	C-CERAMIC,CHIP	100nF,+80-20%,25V,Y5V,TP,1608,	
C901	2203-000189	C-CERAMIC,CHIP	100nF,+80-20%,25V,Y5V,TP,1608,	
C915	2203-005137	C-CERAMIC,CHIP	10uF,+80-20%,50V,JE,TP,5650,-	
C916	2203-005137	C-CERAMIC,CHIP	10uF,+80-20%,50V,JE,TP,5650,-	
C917	2203-005137	C-CERAMIC,CHIP	10uF,+80-20%,50V,JE,TP,5650,-	
C918	2203-005137	C-CERAMIC,CHIP	10uF,+80-20%,50V,JE,TP,5650,-	
C919	2203-000575	C-CERAMIC,CHIP	220NF,10%,25V,X7R,TP,2012	
C920	2203-000925	C-CERAMIC,CHIP	470NF,+80-20%,50V,Y5V,TP,2012	
C921	2203-001048	C-CERAMIC,CHIP	0.56nF,10%,50V,NPO,TP,2012	
C922	2203-001652	C-CERAMIC,CHIP	470nF,+80-20%,16V,Y5V,TP,1608	
C923	2409-001065	C-ORGANIC	82UF,20%,16V,WT,TP,8X6.9MM,-	
C924	2409-001065	C-ORGANIC	82UF,20%,16V,WT,TP,8X6.9MM,-	
C925	2409-001065	C-ORGANIC	82UF,20%,16V,WT,TP,8X6.9MM,-	
C926	2409-001065	C-ORGANIC	82UF,20%,16V,WT,TP,8X6.9MM,-	
C927	2409-001065	C-ORGANIC	82UF,20%,16V,WT,TP,8X6.9MM,-	
C928	2203-005137	C-CERAMIC,CHIP	10uF,+80-20%,50V,JE,TP,5650,-	
C929	2203-000206	C-CERAMIC,CHIP	100nF,10%,50V,X7R,TP,2012	
C930	2203-001724	C-CERAMIC,CHIP	4700NF,+80-20%,16V,Y5V,TP,3216	
C931	2203-000189	C-CERAMIC,CHIP	100nF,+80-20%,25V,Y5V,TP,1608,	
C932	2203-000491	C-CERAMIC,CHIP	2.2nF,10%,50V,X7R,TP,1608,-	
C935	2402-001044	C-AL,SMD	100UF,20%,25V,GP,TP,8.3X8.3X6.3MM	

Loc. No.	Code No.	Description	Specification	Remarks
C936	2402-001044	C-AL,SMD	100UF,20%,25V,GP,TP,8.3X8.3X6.3MM	
C937	2409-001035	C-ORGANIC	10uF,20%,10V,LZ,TP,5.4x4.3x4.3mm,1	
C938	2203-000257	C-CERAMIC,CHIP	10nF,10%,50V,X7R,TP,1608	
C939	2203-000189	C-CERAMIC,CHIP	100nF,+80-20%,25V,Y5V,TP,1608,	
C940	2203-005137	C-CERAMIC,CHIP	10uF,+80-20%,50V,JE,TP,5650,-	
C941	2203-005137	C-CERAMIC,CHIP	10uF,+80-20%,50V,JE,TP,5650,-	
C942	2203-000257	C-CERAMIC,CHIP	10nF,10%,50V,X7R,TP,1608	
C943	2203-000189	C-CERAMIC,CHIP	100nF,+80-20%,25V,Y5V,TP,1608,	
C944	2203-005137	C-CERAMIC,CHIP	10uF,+80-20%,50V,JE,TP,5650,-	
C945	2203-005137	C-CERAMIC,CHIP	10uF,+80-20%,50V,JE,TP,5650,-	
C946	2203-000189	C-CERAMIC,CHIP	100nF,+80-20%,25V,Y5V,TP,1608,	
C947	2203-000257	C-CERAMIC,CHIP	10nF,10%,50V,X7R,TP,1608	
C948	2203-000189	C-CERAMIC,CHIP	100nF,+80-20%,25V,Y5V,TP,1608,	
C949	2402-001044	C-AL,SMD	100UF,20%,25V,GP,TP,8.3X8.3X6.3MM	
C950	2203-000257	C-CERAMIC,CHIP	10nF,10%,50V,X7R,TP,1608	
C951	2203-000189	C-CERAMIC,CHIP	100nF,+80-20%,25V,Y5V,TP,1608,	
C952	2409-001065	C-ORGANIC	82UF,20%,16V,WT,TP,8X6.9MM,-	
C953	2402-001044	C-AL,SMD	100UF,20%,25V,GP,TP,8.3X8.3X6.3MM	
C954	2402-001044	C-AL,SMD	100UF,20%,25V,GP,TP,8.3X8.3X6.3MM	
C955	2402-001044	C-AL,SMD	100UF,20%,25V,GP,TP,8.3X8.3X6.3MM	
C956	2203-000257	C-CERAMIC,CHIP	10nF,10%,50V,X7R,TP,1608	
C957	2203-000189	C-CERAMIC,CHIP	100nF,+80-20%,25V,Y5V,TP,1608,	
C958	2203-005137	C-CERAMIC,CHIP	10uF,+80-20%,50V,JE,TP,5650,-	
C959	2203-005137	C-CERAMIC,CHIP	10uF,+80-20%,50V,JE,TP,5650,-	
C960	2203-000257	C-CERAMIC,CHIP	10nF,10%,50V,X7R,TP,1608	
C961	2203-000189	C-CERAMIC,CHIP	100nF,+80-20%,25V,Y5V,TP,1608,	
C962	2402-001044	C-AL,SMD	100UF,20%,25V,GP,TP,8.3X8.3X6.3MM	
C963	2203-000257	C-CERAMIC,CHIP	10nF,10%,50V,X7R,TP,1608	
C964	2203-000189	C-CERAMIC,CHIP	100nF,+80-20%,25V,Y5V,TP,1608,	
C965	2409-001065	C-ORGANIC	82UF,20%,16V,WT,TP,8X6.9MM,-	
C966	2402-001044	C-AL,SMD	100UF,20%,25V,GP,TP,8.3X8.3X6.3MM	
C967	2402-001044	C-AL,SMD	100UF,20%,25V,GP,TP,8.3X8.3X6.3MM	
C968	2402-001044	C-AL,SMD	100UF,20%,25V,GP,TP,8.3X8.3X6.3MM	
C969	2203-000257	C-CERAMIC,CHIP	10nF,10%,50V,X7R,TP,1608	
C970	2203-000189	C-CERAMIC,CHIP	100nF,+80-20%,25V,Y5V,TP,1608,	
C971	2203-005137	C-CERAMIC,CHIP	10uF,+80-20%,50V,JE,TP,5650,-	
C972	2203-005137	C-CERAMIC,CHIP	10uF,+80-20%,50V,JE,TP,5650,-	
C973	2409-001065	C-ORGANIC	82UF,20%,16V,WT,TP,8X6.9MM,-	
C974	2203-000189	C-CERAMIC,CHIP	100nF,+80-20%,25V,Y5V,TP,1608,	
C975	2402-001155	C-AL,SMD	47UF,20%,16V,WT,TP,6.3X5.2MM	
C976	2402-001044	C-AL,SMD	100UF,20%,25V,GP,TP,8.3X8.3X6.3MM	
C977	2203-005005	C-CERAMIC,CHIP	100nF,10%,16V,X7R,TP,1608	
C978	2402-001155	C-AL,SMD	47UF,20%,16V,WT,TP,6.3X5.2MM	
C979	2402-001044	C-AL,SMD	100UF,20%,25V,GP,TP,8.3X8.3X6.3MM	
C980	2203-005005	C-CERAMIC,CHIP	100nF,10%,16V,X7R,TP,1608	
C981	2409-001035	C-ORGANIC	10uF,20%,10V,LZ,TP,5.4x4.3x4.3mm,1	
C982	2402-000176	C-AL,SMD	10uF,20%,16V,GP,TP,4.3x4.3x5.4	
C983	2402-000176	C-AL,SMD	10uF,20%,16V,GP,TP,4.3x4.3x5.4	
C984	2203-005005	C-CERAMIC,CHIP	100nF,10%,16V,X7R,TP,1608	
C985	2203-005005	C-CERAMIC,CHIP	100nF,10%,16V,X7R,TP,1608	
C986	2203-000257	C-CERAMIC,CHIP	10nF,10%,50V,X7R,TP,1608	
C987	2203-000189	C-CERAMIC,CHIP	100nF,+80-20%,25V,Y5V,TP,1608,	
C988	2203-005137	C-CERAMIC,CHIP	10uF,+80-20%,50V,JE,TP,5650,-	
C989	2203-005137	C-CERAMIC,CHIP	10uF,+80-20%,50V,JE,TP,5650,-	
C990	2203-005065	C-CERAMIC,CHIP	1000nF,+80-20%,10V,Y5V,TP,1608	
C991	2409-001065	C-ORGANIC	82UF,20%,16V,WT,TP,8X6.9MM,-	
C992	2409-001035	C-ORGANIC	10uF,20%,10V,LZ,TP,5.4x4.3x4.3mm,1	
C993	2203-000189	C-CERAMIC,CHIP	100nF,+80-20%,25V,Y5V,TP,1608,	
C994	2203-000257	C-CERAMIC,CHIP	10nF,10%,50V,X7R,TP,1608	
C995	2203-000189	C-CERAMIC,CHIP	100nF,+80-20%,25V,Y5V,TP,1608,	
C996	2203-005137	C-CERAMIC,CHIP	10uF,+80-20%,50V,JE,TP,5650,-	
C997	2203-005137	C-CERAMIC,CHIP	10uF,+80-20%,50V,JE,TP,5650,-	
C998	2203-005065	C-CERAMIC,CHIP	1000nF,+80-20%,10V,Y5V,TP,1608	
CA201	2503-001018	C-NETWORK	15PFX4,10%,50V,-	
CA202	2503-001018	C-NETWORK	15PFX4,10%,50V,-	
CA203	2503-001018	C-NETWORK	15PFX4,10%,50V,-	
CA204	2503-001018	C-NETWORK	15PFX4,10%,50V,-	
CA205	2503-001018	C-NETWORK	15PFX4,10%,50V,-	
CA206	2503-001018	C-NETWORK	15PFX4,10%,50V,-	
CA207	2503-001018	C-NETWORK	15PFX4,10%,50V,-	

Loc. No.	Code No.	Description	Specification	Remarks
CA208	2503-001018	C-NETWORK	15PFX4,10%,50V,-	
CA209	2503-001018	C-NETWORK	15PFX4,10%,50V,-	
CA210	2503-001018	C-NETWORK	15PFX4,10%,50V,-	
CA211	2503-001018	C-NETWORK	15PFX4,10%,50V,-	
CA212	2503-001018	C-NETWORK	15PFX4,10%,50V,-	
CA401	2503-001018	C-NETWORK	15PFX4,10%,50V,-	
CA402	2503-001018	C-NETWORK	15PFX4,10%,50V,-	
CA403	2503-001018	C-NETWORK	15PFX4,10%,50V,-	
CA404	2503-001018	C-NETWORK	15PFX4,10%,50V,-	
CA801	2503-001018	C-NETWORK	15PFX4,10%,50V,-	
CA802	2503-001018	C-NETWORK	15PFX4,10%,50V,-	
CA803	2503-001018	C-NETWORK	15PFX4,10%,50V,-	
CA804	2503-001018	C-NETWORK	15PFX4,10%,50V,-	
CA805	2503-001018	C-NETWORK	15PFX4,10%,50V,-	
CA806	2503-001018	C-NETWORK	15PFX4,10%,50V,-	
CA807	2503-001018	C-NETWORK	15PFX4,10%,50V,-	
CA808	2503-001018	C-NETWORK	15PFX4,10%,50V,-	
CA809	2503-001018	C-NETWORK	15PFX4,10%,50V,-	
CA810	2503-001018	C-NETWORK	15PFX4,10%,50V,-	
CA811	2503-001018	C-NETWORK	15PFX4,10%,50V,-	
CA812	2503-001018	C-NETWORK	15PFX4,10%,50V,-	
CL950	BN27-00002A	COIL-CHOKE(SMD)	47uH,47uH,20%,12*12*8mm,22.5Ts,SMD,-,-,0.75ohm,-,-,-,TP	
CL951	BN27-00002A	COIL-CHOKE(SMD)	47uH,47uH,20%,12*12*8mm,22.5Ts,SMD,-,-,0.75ohm,-,-,-,TP	
CL952	BN27-00002A	COIL-CHOKE(SMD)	47uH,47uH,20%,12*12*8mm,22.5Ts,SMD,-,-,0.75ohm,-,-,-,TP	
CL954	BN27-00002A	COIL-CHOKE(SMD)	47uH,47uH,20%,12*12*8mm,22.5Ts,SMD,-,-,0.75ohm,-,-,-,TP	
CL955	BN27-00002A	COIL-CHOKE(SMD)	47uH,47uH,20%,12*12*8mm,22.5Ts,SMD,-,-,0.75ohm,-,-,-,TP	
CL956	BN27-00002A	COIL-CHOKE(SMD)	47uH,47uH,20%,12*12*8mm,22.5Ts,SMD,-,-,0.75ohm,-,-,-,TP	
CN1	3711-004070	CONNECTOR-HEADER	BOX,30P,1R,1.25mm,SMD-A,SN	
CN101	3711-002049	CONNECTOR-HEADER	BOX,6P,1R,1.25mm,SMD-A,SN	
CN170	3711-002049	CONNECTOR-HEADER	BOX,6P,1R,1.25mm,SMD-A,SN	
CN201	3711-004070	CONNECTOR-HEADER	BOX,30P,1R,1.25mm,SMD-A,SN	
CN3	3711-003161	CONNECTOR-HEADER	BOX,20P,1R,1.25mm,ANGLE,SN	
CN301	3711-002046	CONNECTOR-HEADER	3WALL,12P,1R,1.25mm,SMD-S,SN	
CN601	3711-002050	CONNECTOR-HEADER	BOX,10P,1R,1.25mm,SMD-A,SN	
CN901	3711-001141	CONNECTOR-HEADER	BOX,9P,1R,1.25mm,SMD-S,SN	
CN903	3711-001141	CONNECTOR-HEADER	BOX,9P,1R,1.25mm,SMD-S,SN	
CN904	3708-001776	CONNECTOR-FPC/FFC/PIC	34P,0.5MM,SMD-A,SN	
CN905	3708-001775	CONNECTOR-FPC/FFC/PIC	30P,0.5MM,SMD-A,SN	
CN951	3711-005085	CONNECTOR-HEADER	BOX,10P,1R,2.0MM,SMD-A,SN,BEG	
CN952	3711-005085	CONNECTOR-HEADER	BOX,10P,1R,2.0MM,SMD-A,SN,BEG	
CN953	3711-005085	CONNECTOR-HEADER	BOX,10P,1R,2.0MM,SMD-A,SN,BEG	
CN954	3711-005085	CONNECTOR-HEADER	BOX,10P,1R,2.0MM,SMD-A,SN,BEG	
CN955	3711-000556	CONNECTOR-HEADER	BOX,12P,1R,1.25mm,SMD-A,SN	
D1	0401-001056	DIODE-SWITCHING	MMBD4148SE,75V,200MA,SOT-23,TP	
D2	0401-001056	DIODE-SWITCHING	MMBD4148SE,75V,200MA,SOT-23,TP	
D201	0401-001116	DIODE-SWITCHING	BAV99DW,75V,150MA,SOT-363,TP	
D202	0401-001116	DIODE-SWITCHING	BAV99DW,75V,150MA,SOT-363,TP	
D203	0401-001116	DIODE-SWITCHING	BAV99DW,75V,150MA,SOT-363,TP	
D204	0401-001116	DIODE-SWITCHING	BAV99DW,75V,150MA,SOT-363,TP	
D205	0401-001116	DIODE-SWITCHING	BAV99DW,75V,150MA,SOT-363,TP	
D206	0401-001116	DIODE-SWITCHING	BAV99DW,75V,150MA,SOT-363,TP	
D207	0401-001116	DIODE-SWITCHING	BAV99DW,75V,150MA,SOT-363,TP	
D208	0401-001116	DIODE-SWITCHING	BAV99DW,75V,150MA,SOT-363,TP	
D3	0401-001056	DIODE-SWITCHING	MMBD4148SE,75V,200MA,SOT-23,TP	
D333	0401-000133	DIODE-SWITCHING	RLS4148,100V,200MA,SOD-80C,TP	
D401	0401-001056	DIODE-SWITCHING	MMBD4148SE,75V,200MA,SOT-23,TP	
D402	0401-001056	DIODE-SWITCHING	MMBD4148SE,75V,200MA,SOT-23,TP	
D403	0401-001056	DIODE-SWITCHING	MMBD4148SE,75V,200MA,SOT-23,TP	
D404	0401-001056	DIODE-SWITCHING	MMBD4148SE,75V,200MA,SOT-23,TP	
D405	0401-001056	DIODE-SWITCHING	MMBD4148SE,75V,200MA,SOT-23,TP	
D406	0401-001056	DIODE-SWITCHING	MMBD4148SE,75V,200MA,SOT-23,TP	
D501	0401-001056	DIODE-SWITCHING	MMBD4148SE,75V,200MA,SOT-23,TP	
D502	0401-001056	DIODE-SWITCHING	MMBD4148SE,75V,200MA,SOT-23,TP	
D503	0401-001056	DIODE-SWITCHING	MMBD4148SE,75V,200MA,SOT-23,TP	
D504	0401-001056	DIODE-SWITCHING	MMBD4148SE,75V,200MA,SOT-23,TP	
D505	0401-001056	DIODE-SWITCHING	MMBD4148SE,75V,200MA,SOT-23,TP	
D506	0401-001056	DIODE-SWITCHING	MMBD4148SE,75V,200MA,SOT-23,TP	
D507	0401-001056	DIODE-SWITCHING	MMBD4148SE,75V,200MA,SOT-23,TP	
D508	0401-001056	DIODE-SWITCHING	MMBD4148SE,75V,200MA,SOT-23,TP	
D6	0401-001056	DIODE-SWITCHING	MMBD4148SE,75V,200MA,SOT-23,TP	



Loc. No.	Code No.	Description	Specification	Remarks
D7	0401-001056	DIODE-SWITCHING	MMBD4148SE,75V,200MA,SOT-23,TP	
D8	0401-001056	DIODE-SWITCHING	MMBD4148SE,75V,200MA,SOT-23,TP	
D9	0401-001056	DIODE-SWITCHING	MMBD4148SE,75V,200MA,SOT-23,TP	
D901	0404-001084	DIODE-SCHOTTKY	BAT54A,30V,200MA,SOT-23,TP	
D902	0404-001055	DIODE-SCHOTTKY	-.60V,3000MA,SMC,TP	
D903	0404-001055	DIODE-SCHOTTKY	-.60V,3000MA,SMC,TP	
D904	0401-000133	DIODE-SWITCHING	RLS4148,100V,200MA,SOD-80C,TP	
FT1	2909-001051	FILTER-LC	6MHz,6MHz,0.8dB,TP,5dB/6MHz,30dB/14.3MHz	
FT1001	3301-001145	CORE-FERRITE BEAD	AB,4.5x1.6x1.6mm,-,-	
FT101	2901-001114	FILTER-EMI SMD	25VDC,2.0ADC,-,100nF,3.2x1.6x1	
FT102	2901-001114	FILTER-EMI SMD	25VDC,2.0ADC,-,100nF,3.2x1.6x1	
FT103	2901-001114	FILTER-EMI SMD	25VDC,2.0ADC,-,100nF,3.2x1.6x1	
FT104	2901-001114	FILTER-EMI SMD	25VDC,2.0ADC,-,100nF,3.2x1.6x1	
FT105	2901-001114	FILTER-EMI SMD	25VDC,2.0ADC,-,100nF,3.2x1.6x1	
FT106	2901-001114	FILTER-EMI SMD	25VDC,2.0ADC,-,100nF,3.2x1.6x1	
FT108	2901-001114	FILTER-EMI SMD	25VDC,2.0ADC,-,100nF,3.2x1.6x1	
FT109	2901-001114	FILTER-EMI SMD	25VDC,2.0ADC,-,100nF,3.2x1.6x1	
FT110	2901-001114	FILTER-EMI SMD	25VDC,2.0ADC,-,100nF,3.2x1.6x1	
FT1111	3301-001145	CORE-FERRITE BEAD	AB,4.5x1.6x1.6mm,-,-	
FT2	2909-001051	FILTER-LC	6MHz,6MHz,0.8dB,TP,5dB/6MHz,30dB/14.3MHz	
FT201	2901-001114	FILTER-EMI SMD	25VDC,2.0ADC,-,100nF,3.2x1.6x1	
FT202	2901-001114	FILTER-EMI SMD	25VDC,2.0ADC,-,100nF,3.2x1.6x1	
FT203	2901-001114	FILTER-EMI SMD	25VDC,2.0ADC,-,100nF,3.2x1.6x1	
FT204	2901-001114	FILTER-EMI SMD	25VDC,2.0ADC,-,100nF,3.2x1.6x1	
FT205	2901-001114	FILTER-EMI SMD	25VDC,2.0ADC,-,100nF,3.2x1.6x1	
FT206	2901-001114	FILTER-EMI SMD	25VDC,2.0ADC,-,100nF,3.2x1.6x1	
FT209	2901-001114	FILTER-EMI SMD	25VDC,2.0ADC,-,100nF,3.2x1.6x1	
FT220	2901-001114	FILTER-EMI SMD	25VDC,2.0ADC,-,100nF,3.2x1.6x1	
FT3	2909-001051	FILTER-LC	6MHz,6MHz,0.8dB,TP,5dB/6MHz,30dB/14.3MHz	
FT302	2901-001114	FILTER-EMI SMD	25VDC,2.0ADC,-,100nF,3.2x1.6x1	
FT401	2901-001114	FILTER-EMI SMD	25VDC,2.0ADC,-,100nF,3.2x1.6x1	
FT402	2901-001114	FILTER-EMI SMD	25VDC,2.0ADC,-,100nF,3.2x1.6x1	
FT403	2901-001114	FILTER-EMI SMD	25VDC,2.0ADC,-,100nF,3.2x1.6x1	
FT404	2901-001114	FILTER-EMI SMD	25VDC,2.0ADC,-,100nF,3.2x1.6x1	
FT601	2901-001114	FILTER-EMI SMD	25VDC,2.0ADC,-,100nF,3.2x1.6x1	
FT602	2901-001114	FILTER-EMI SMD	25VDC,2.0ADC,-,100nF,3.2x1.6x1	
FT603	2901-001114	FILTER-EMI SMD	25VDC,2.0ADC,-,100nF,3.2x1.6x1	
FT604	2901-001114	FILTER-EMI SMD	25VDC,2.0ADC,-,100nF,3.2x1.6x1	
FT605	2901-001114	FILTER-EMI SMD	25VDC,2.0ADC,-,100nF,3.2x1.6x1	
FT606	2901-001114	FILTER-EMI SMD	25VDC,2.0ADC,-,100nF,3.2x1.6x1	
FT607	2901-001114	FILTER-EMI SMD	25VDC,2.0ADC,-,100nF,3.2x1.6x1	
FT608	2901-001114	FILTER-EMI SMD	25VDC,2.0ADC,-,100nF,3.2x1.6x1	
FT609	2901-001114	FILTER-EMI SMD	25VDC,2.0ADC,-,100nF,3.2x1.6x1	
FT701	2901-001114	FILTER-EMI SMD	25VDC,2.0ADC,-,100nF,3.2x1.6x1	
FT702	2901-001114	FILTER-EMI SMD	25VDC,2.0ADC,-,100nF,3.2x1.6x1	
FT703	2901-001114	FILTER-EMI SMD	25VDC,2.0ADC,-,100nF,3.2x1.6x1	
FT704	2901-001114	FILTER-EMI SMD	25VDC,2.0ADC,-,100nF,3.2x1.6x1	
FT705	2901-001114	FILTER-EMI SMD	25VDC,2.0ADC,-,100nF,3.2x1.6x1	
FT706	3301-001145	CORE-FERRITE BEAD	AB,4.5x1.6x1.6mm,-,-	
FT801	2901-001114	FILTER-EMI SMD	25VDC,2.0ADC,-,100nF,3.2x1.6x1	
FT802	2901-001114	FILTER-EMI SMD	25VDC,2.0ADC,-,100nF,3.2x1.6x1	
FT803	2901-001114	FILTER-EMI SMD	25VDC,2.0ADC,-,100nF,3.2x1.6x1	
FT804	2901-001114	FILTER-EMI SMD	25VDC,2.0ADC,-,100nF,3.2x1.6x1	
FT805	2901-001114	FILTER-EMI SMD	25VDC,2.0ADC,-,100nF,3.2x1.6x1	
FT806	2901-001114	FILTER-EMI SMD	25VDC,2.0ADC,-,100nF,3.2x1.6x1	
FT807	2901-001114	FILTER-EMI SMD	25VDC,2.0ADC,-,100nF,3.2x1.6x1	
FT808	2901-001114	FILTER-EMI SMD	25VDC,2.0ADC,-,100nF,3.2x1.6x1	
FT901	2901-001114	FILTER-EMI SMD	25VDC,2.0ADC,-,100nF,3.2x1.6x1	
FT903	3301-001145	CORE-FERRITE BEAD	AB,4.5x1.6x1.6mm,-,-	
FT950	3301-001145	CORE-FERRITE BEAD	AB,4.5x1.6x1.6mm,-,-	
FT951	3301-001145	CORE-FERRITE BEAD	AB,4.5x1.6x1.6mm,-,-	
FT952	3301-001145	CORE-FERRITE BEAD	AB,4.5x1.6x1.6mm,-,-	
FT953	3301-001145	CORE-FERRITE BEAD	AB,4.5x1.6x1.6mm,-,-	
FT954	3301-001145	CORE-FERRITE BEAD	AB,4.5x1.6x1.6mm,-,-	
FT955	3301-001145	CORE-FERRITE BEAD	AB,4.5x1.6x1.6mm,-,-	
FT956	3301-001145	CORE-FERRITE BEAD	AB,4.5x1.6x1.6mm,-,-	
FT957	3301-001145	CORE-FERRITE BEAD	AB,4.5x1.6x1.6mm,-,-	
FT958	3301-001145	CORE-FERRITE BEAD	AB,4.5x1.6x1.6mm,-,-	
FT959	3301-001145	CORE-FERRITE BEAD	AB,4.5x1.6x1.6mm,-,-	
FT960	3301-001145	CORE-FERRITE BEAD	AB,4.5x1.6x1.6mm,-,-	

Loc. No.	Code No.	Description	Specification	Remarks
FT961	3301-001145	CORE-FERRITE BEAD	AB,4.5x1.6x1.6mm,-,-	
FT962	3301-001145	CORE-FERRITE BEAD	AB,4.5x1.6x1.6mm,-,-	
FT963	3301-001145	CORE-FERRITE BEAD	AB,4.5x1.6x1.6mm,-,-	
FT964	3301-001145	CORE-FERRITE BEAD	AB,4.5x1.6x1.6mm,-,-	
FT965	3301-001145	CORE-FERRITE BEAD	AB,4.5x1.6x1.6mm,-,-	
FT966	3301-001145	CORE-FERRITE BEAD	AB,4.5x1.6x1.6mm,-,-	
FT967	3301-001145	CORE-FERRITE BEAD	AB,4.5x1.6x1.6mm,-,-	
FT969	3301-001145	CORE-FERRITE BEAD	AB,4.5x1.6x1.6mm,-,-	
FT970	3301-001145	CORE-FERRITE BEAD	AB,4.5x1.6x1.6mm,-,-	
FT972	3301-001145	CORE-FERRITE BEAD	AB,4.5x1.6x1.6mm,-,-	
FT973	3301-001145	CORE-FERRITE BEAD	AB,4.5x1.6x1.6mm,-,-	
FT976	3301-001145	CORE-FERRITE BEAD	AB,4.5x1.6x1.6mm,-,-	
FT977	3301-001145	CORE-FERRITE BEAD	AB,4.5x1.6x1.6mm,-,-	
FT978	3301-001145	CORE-FERRITE BEAD	AB,4.5x1.6x1.6mm,-,-	
FT979	3301-001145	CORE-FERRITE BEAD	AB,4.5x1.6x1.6mm,-,-	
IC1001	1203-001448	IC-SWITCH VOL. REG.	2596,TO-263,5P,-,PLASTIC,4.750	
IC1002	1204-001814	IC-SELECTOR	CXA2151Q,QFP,48P,144MIL,PLASTIC,5.5V,1.4W,-,22TO+75C,TR,-	
IC101	1203-001559	IC-RESET	DS1834,SOIC,8P,150MIL,-,1.2/5V	
IC102	1103-001223	IC-EEPROM	24C16,2048x8Bit,SOP,8P,150MIL,10mS,2.7V,-,PLASTIC,0to+70C,4uA,CMOS,TP	
IC103	0903-001202	IC-MICROCONTROLLER	80251G2,8Bit,PLCC,44P,653MIL,24MHz,TR,CMOS,PLASTIC,5V,1.5W,0to+70C,1KBYTE,-,24Bi	
IC104	0801-002559	IC-CMOS LOGIC	74LVX74,D,FLIP-FLOP,TSSOP,14P,173MIL,DUAL,TP,PLASTIC,-,-,0.36V,-40to+85C,180mW,2	
IC105_SOCKET	3704-000249	SOCKET-IC	32P,PLCC,SN,1.27mm	
IC106	0801-002574	IC-CMOS LOGIC	74LVX04,INVERTER,SOP,14P,150MIL,HEX,TP,PLASTIC,-,-,0.36V,-40to+85C,180mW,2.4V,20	
IC107	0801-002394	IC-CMOS LOGIC	74LCX32,OR GATE,SOIC,14P,150MI	
IC109	0801-002576	IC-CMOS LOGIC	74LVX373,LATCH,SOP,20P,300MIL,OCTAL,TP,PLASTIC,3-STATE,-,-,0.36V,-40to+85C,180mW,2	
IC110	0801-002268	IC-CMOS LOGIC	74VHC139,DECODER,SOP,16P,150MI	
IC111	0909-001036	IC-REAL TIME CLOCK	DS1337S,-,SO,8P,150MIL,400KHZ,TP,CMOS,PLASTIC,3.3V,-,-40TO+85C,-,-,-,-,-	
IC112	0801-002394	IC-CMOS LOGIC	74LCX32,OR GATE,SOIC,14P,150MI	
IC2	1204-001935	IC-SEPARATOR	UPD64083GF,QFP,100P,14X20MM,PLASTIC,3.6V,-,0TO+70C,TP,UPD64083GF	
IC201	1203-002067	IC-POSI.FIXED REG.	3330,SOT-23,6P,65MIL,PLASTIC,3.284/3.316V,-,-40to+125C,200mA,-,TP	
IC202	1203-002067	IC-POSI.FIXED REG.	3330,SOT-23,6P,65MIL,PLASTIC,3.284/3.316V,-,-40to+125C,200mA,-,TP	
IC203	1002-001292	IC-A/D CONVERTER	AD9883AKST-110,8BITS,QFP,80P,551MIL,*ao:5LSB,TR,CMOS,PLASTIC,3.3V,-,25TO+85C,650M	
IC204	1205-002183	IC-RECEIVER	SI1161BCT100,TOFP,100P,14X14MM,PLASTIC,3.6V,-,0TO+70C,TR,PANELLINK	
IC205	0801-002267	IC-CMOS LOGIC	74LCX14,-,SOIC,14P,150MIL,-,TP,-,-,-,3.6V,-40TO+85C,-,5.5V,-,-,24MA	
IC206	1203-002067	IC-POSI.FIXED REG.	3330,SOT-23,6P,65MIL,PLASTIC,3.284/3.316V,-,-40to+125C,200mA,-,TP	
IC207	1103-000129	IC-EEPROM	24C02,256x8BIT,SOP,8P,150MIL,1	
IC301	1203-002454	IC-VOLTAGE REGULATOR	FAN1117A,TO-252,3P,257MIL,PLASTIC,1.764V/1.836V,-,0TO+125C,1A,1.225/1.275V,TP	
IC302	1204-001973	IC-DECODER	VSP9437B,MQFP,80P,14X14MM,PLASTIC,3.47V,1.6W,0TO+70C,TR,VSP9437B	
IC303	1301-001543	IC-CPLD	EPM3032A,TOFP,44P,-,10NS,3.3V,10%,-,0TO+70C,PLASTIC,34.34,2.125MHZ,3.725V,-,-,10	
IC304	1001-001146	IC-ANALOG SWITCH	FST3257,BUS SWITCH & CMOS,SOP,16P,150MIL,QUAD,5.5V,-40to+85C,PLASTIC,-,15ohm,-,-	
IC306	1001-001082	IC-VIDEO SWITCH	BA7657F,-,SOP,24P,300MIL,SINGL	
IC401	1203-002067	IC-POSI.FIXED REG.	3330,SOT-23,6P,65MIL,PLASTIC,3.284/3.316V,-,-40to+125C,200mA,-,TP	
IC402	1203-002067	IC-POSI.FIXED REG.	3330,SOT-23,6P,65MIL,PLASTIC,3.284/3.316V,-,-40to+125C,200mA,-,TP	
IC403	1001-001082	IC-VIDEO SWITCH	BA7657F,-,SOP,24P,300MIL,SINGL	
IC404	1002-001292	IC-A/D CONVERTER	AD9883AKST-110,8BITS,QFP,80P,551MIL,*ao:5LSB,TR,CMOS,PLASTIC,3.3V,-,25TO+85C,650M	
IC405	0801-002559	IC-CMOS LOGIC	74LVX74,D,FLIP-FLOP,TSSOP,14P,173MIL,DUAL,TP,PLASTIC,-,-,0.36V,-40to+85C,180mW,2	
IC406	1001-001146	IC-ANALOG SWITCH	FST3257,BUS SWITCH & CMOS,SOP,16P,150MIL,QUAD,5.5V,-40to+85C,PLASTIC,-,15ohm,-,-	
IC501	1203-001816	IC-POSI.FIXED REG.	78M08,TO-252,3P,-,PLASTIC,7.7/8.3V,1.0W,-40TO+85C,0.5A,-,TP	
IC502	1203-001488	IC-POSI.FIXED REG.	7805,TO-252,3P,-,PLASTIC,4.8/5	
IC503	1204-001675	IC-SOUND PROCESSOR	MSP3451G,QFP,80P,-,PLASTIC,9V,1000mW,0to+70C,TR,Multistandard Sound	
IC504	1201-001681	IC-AUDIO AMP	1101,SOP,30P,433MIL,-,-,PLASTIC,13.2V,-,0to+70C,-,-,-,-,-,TP	
IC505	1201-001495	IC-AUDIO AMP	7050,SOP,8P,150MIL,DUAL,26DB,PLASTIC,6V,0.25W,-,40DB,-,-,20NA,-	
IC601	1105-001336	IC-DRAM	4S643232,512Kx32x4Bit,TSOP,86P,400MIL,60nS,3.3V,10%,PLASTIC,0to+70C,2mA,CMOS,TP	
IC602	1105-001336	IC-DRAM	4S643232,512Kx32x4Bit,TSOP,86P,400MIL,60nS,3.3V,10%,PLASTIC,0to+70C,2mA,CMOS,TP	
IC603	1205-002028	IC-LCD CONTROLLER	JAGASM,BGA,388P,208MIL,PALATIC,3.45V,2.5W,-40TO+125C,TR,DIGITAL DISPLAY PRO.	
IC604	0801-002267	IC-CMOS LOGIC	74LCX14,-,SOIC,14P,150MIL,-,TP,-,-,-,3.6V,-40TO+85C,-,5.5V,-,-,24MA	
IC701	1001-001146	IC-ANALOG SWITCH	FST3257,BUS SWITCH & CMOS,SOP,16P,150MIL,QUAD,5.5V,-40to+85C,PLASTIC,-,15ohm,-,-	
IC702	1001-001190	IC-ANALOG SWITCH	FST16233MTD,BUS SWITCH,TSSOP,56P,240MIL,-,5.5V,-40TO+85C,PLASTIC,-,200HM,8.5NS,7	
IC703	1204-002019	IC-VIDEO PROCESS	MDIN-100,QFP,256P,28X28MM,PLASTIC,3.3V,-,0TO+70C,TR,-	
IC704	1105-001336	IC-DRAM	4S643232,512Kx32x4Bit,TSOP,86P,400MIL,60nS,3.3V,10%,PLASTIC,0to+70C,2mA,CMOS,TP	
IC801	1205-002028	IC-LCD CONTROLLER	JAGASM,BGA,388P,208MIL,PALATIC,3.45V,2.5W,-40TO+125C,TR,DIGITAL DISPLAY PRO.	
IC802	1105-001336	IC-DRAM	4S643232,512Kx32x4Bit,TSOP,86P,400MIL,60nS,3.3V,10%,PLASTIC,0to+70C,2mA,CMOS,TP	
IC803	1105-001336	IC-DRAM	4S643232,512Kx32x4Bit,TSOP,86P,400MIL,60nS,3.3V,10%,PLASTIC,0to+70C,2mA,CMOS,TP	
IC904	1203-001432	IC-POSI.FIXED REG.	78M12,DPAK,3P,-,PLASTIC,11.5/1	
IC905	0505-000275	FET-SILICON	SI4435DY,P,30V,+8.0A,0.014ohm,2.5W,SO-8	
IC906	1203-002191	IC-DC/DC CONVERTER	LTC1778,SSOP,16P,153MIL,PLASTIC,-,-,125C,-,-,TP	
IC950	1203-001465	IC-POSI.ADJUST REG.	317,TO-263,3P,-,PLASTIC,1.2/37	
IC951	1203-001448	IC-SWITCH VOL. REG.	2596,TO-263,5P,-,PLASTIC,4.750	
IC952	1203-001448	IC-SWITCH VOL. REG.	2596,TO-263,5P,-,PLASTIC,4.750	
IC953	1203-002411	IC-POSI.FIXED REG.	IRU1030-33CM,TO-263,3P,-,PLASTIC,3.267/3.333V,-,0TO+150C,-,-,ST	

Loc. No.	Code No.	Description	Specification	Remarks
IC954	1203-002411	IC-POS.FIXED REG.	IRU1030-33CM,TO-263,3P,-,PLASTIC,3.267/3.333V,-,OTO+150C,-,-,ST	
IC955	1203-001448	IC-SWITCH VOL. REG.	2596,TO-263,5P,-,PLASTIC,4.750	
IC956	1203-002411	IC-POS.FIXED REG.	IRU1030-33CM,TO-263,3P,-,PLASTIC,3.267/3.333V,-,OTO+150C,-,-,ST	
IC957	1203-002411	IC-POS.FIXED REG.	IRU1030-33CM,TO-263,3P,-,PLASTIC,3.267/3.333V,-,OTO+150C,-,-,ST	
IC958	1203-001448	IC-SWITCH VOL. REG.	2596,TO-263,5P,-,PLASTIC,4.750	
IC959	1203-001815	IC-POS.FIXED REG.	78M09,TO-252,3P,-,PLASTIC,8.6/9.4V,1.0W,-40TO+85C,0.5A,-,TP	
IC960	1203-001815	IC-POS.FIXED REG.	78M09,TO-252,3P,-,PLASTIC,8.6/9.4V,1.0W,-40TO+85C,0.5A,-,TP	
IC961	1203-001465	IC-POS.ADJUST REG.	317,TO-263,3P,-,PLASTIC,1.2/37	
IC962	1203-002199	IC-POS.FIXED REG.	LM2596,TO-263,5P,340MIL,PALSTIC,-,-,40TO+125C,-,-,ST	
IC963	0505-001170	FET-SILICON	SI9933ADY-T1,P,-,20V,3.4A,0.06ohm,2W,SO-8	
IC964	1203-001465	IC-POS.ADJUST REG.	317,TO-263,3P,-,PLASTIC,1.2/37	
IC965	1203-002199	IC-POS.FIXED REG.	LM2596,TO-263,5P,340MIL,PALSTIC,-,-,40TO+125C,-,-,ST	
L1	2703-000398	INDUCTOR-SMD	10uH,10%,3.2x2.5x2.2mm	
L10	2703-000398	INDUCTOR-SMD	10uH,10%,3.2x2.5x2.2mm	
L1001	2703-001334	INDUCTOR-SMD	1.5uH,10%,2x1.25x0.85mm	
L1002	BN27-00002A	COIL-CHOKE(SMD)	47uH,47uH,20%,12*12*8mm,22.5Ts,SMD,-,-,0.75ohm,-,-,-,TP	
L101	2703-001334	INDUCTOR-SMD	1.5uH,10%,2x1.25x0.85mm	
L11	2703-000398	INDUCTOR-SMD	10uH,10%,3.2x2.5x2.2mm	
L12	2703-001778	INDUCTOR-SMD	3.3UH,20%,3.2X2.5X2.2MM	
L14	2703-000398	INDUCTOR-SMD	10uH,10%,3.2x2.5x2.2mm	
L16	2703-000398	INDUCTOR-SMD	10uH,10%,3.2x2.5x2.2mm	
L17	2703-000398	INDUCTOR-SMD	10uH,10%,3.2x2.5x2.2mm	
L18	2703-000398	INDUCTOR-SMD	10uH,10%,3.2x2.5x2.2mm	
L19	2703-000398	INDUCTOR-SMD	10uH,10%,3.2x2.5x2.2mm	
L2	2703-000398	INDUCTOR-SMD	10uH,10%,3.2x2.5x2.2mm	
L204	2703-001334	INDUCTOR-SMD	1.5uH,10%,2x1.25x0.85mm	
L27	2703-000398	INDUCTOR-SMD	10uH,10%,3.2x2.5x2.2mm	
L28	2703-000398	INDUCTOR-SMD	10uH,10%,3.2x2.5x2.2mm	
L3	2703-000398	INDUCTOR-SMD	10uH,10%,3.2x2.5x2.2mm	
L301	2703-001778	INDUCTOR-SMD	3.3UH,20%,3.2X2.5X2.2MM	
L302	2703-001778	INDUCTOR-SMD	3.3UH,20%,3.2X2.5X2.2MM	
L4	2703-001896	INDUCTOR-SMD	10uH,5%,3.2x2.5x2.2mm	
L401	2703-001334	INDUCTOR-SMD	1.5uH,10%,2x1.25x0.85mm	
L501	2703-001778	INDUCTOR-SMD	3.3UH,20%,3.2X2.5X2.2MM	
L502	BN27-00007A	COIL CHOKE-SMD	DHB0504-100,RB15/17NS,10UH,±æ10%,-,0.080HM,1.5A,DR5.8X4.5,20.5TS,6.0X5.2X4.5MM,-	
L503	BN27-00007A	COIL CHOKE-SMD	DHB0504-100,RB15/17NS,10UH,±æ10%,-,0.080HM,1.5A,DR5.8X4.5,20.5TS,6.0X5.2X4.5MM,-	
L504	BN27-00007A	COIL CHOKE-SMD	DHB0504-100,RB15/17NS,10UH,±æ10%,-,0.080HM,1.5A,DR5.8X4.5,20.5TS,6.0X5.2X4.5MM,-	
L505	BN27-00007A	COIL CHOKE-SMD	DHB0504-100,RB15/17NS,10UH,±æ10%,-,0.080HM,1.5A,DR5.8X4.5,20.5TS,6.0X5.2X4.5MM,-	
L506	2703-001778	INDUCTOR-SMD	3.3UH,20%,3.2X2.5X2.2MM	
L6	2703-000398	INDUCTOR-SMD	10uH,10%,3.2x2.5x2.2mm	
L701	2703-001778	INDUCTOR-SMD	3.3UH,20%,3.2X2.5X2.2MM	
L702	2703-001778	INDUCTOR-SMD	3.3UH,20%,3.2X2.5X2.2MM	
L9	2703-000398	INDUCTOR-SMD	10uH,10%,3.2x2.5x2.2mm	
MP1.0	BN41-00193A	PCB-MAIN	LT29A13W,FR-4,4L,A,1.6T,330X210,APOLLO2,1A	
Q1	0501-000280	TR-SMALL SIGNAL	KSA1182,PNP,150mW,SOT-23,TP,70	
Q10	0501-000280	TR-SMALL SIGNAL	KSA1182,PNP,150mW,SOT-23,TP,70	
Q1001	0501-002080	TR-SMALL SIGNAL	2SC2412K,NPN,200mW,SC-59,TP,120-270	
Q101	0501-002080	TR-SMALL SIGNAL	2SC2412K,NPN,200mW,SC-59,TP,120-270	
Q11	0501-000280	TR-SMALL SIGNAL	KSA1182,PNP,150mW,SOT-23,TP,70	
Q12	0501-002080	TR-SMALL SIGNAL	2SC2412K,NPN,200mW,SC-59,TP,120-270	
Q13	0501-000280	TR-SMALL SIGNAL	KSA1182,PNP,150mW,SOT-23,TP,70	
Q14	0501-002080	TR-SMALL SIGNAL	2SC2412K,NPN,200mW,SC-59,TP,120-270	
Q15	0501-002080	TR-SMALL SIGNAL	2SC2412K,NPN,200mW,SC-59,TP,120-270	
Q16	0501-000280	TR-SMALL SIGNAL	KSA1182,PNP,150mW,SOT-23,TP,70	
Q2	0501-002080	TR-SMALL SIGNAL	2SC2412K,NPN,200mW,SC-59,TP,120-270	
Q3	0501-002080	TR-SMALL SIGNAL	2SC2412K,NPN,200mW,SC-59,TP,120-270	
Q4	0501-000280	TR-SMALL SIGNAL	KSA1182,PNP,150mW,SOT-23,TP,70	
Q5	0501-000280	TR-SMALL SIGNAL	KSA1182,PNP,150mW,SOT-23,TP,70	
Q501	0501-002080	TR-SMALL SIGNAL	2SC2412K,NPN,200mW,SC-59,TP,120-270	
Q6	0501-002080	TR-SMALL SIGNAL	2SC2412K,NPN,200mW,SC-59,TP,120-270	
Q7	0501-000280	TR-SMALL SIGNAL	KSA1182,PNP,150mW,SOT-23,TP,70	
Q8	0501-000280	TR-SMALL SIGNAL	KSA1182,PNP,150mW,SOT-23,TP,70	
Q901	0501-002080	TR-SMALL SIGNAL	2SC2412K,NPN,200mW,SC-59,TP,120-270	
Q902	0505-001663	FET-SILICON	FOB50N06L,N,60V,52.4,0.0210HM,3.75W,D-PAK	
Q903	0505-001663	FET-SILICON	FOB50N06L,N,60V,52.4,0.0210HM,3.75W,D-PAK	
Q904	0505-001662	FET-SILICON	FDB5645,N,60V,80A,0.00950HM,125W,TO-263AB	
Q905	0505-001662	FET-SILICON	FDB5645,N,60V,80A,0.00950HM,125W,TO-263AB	
Q950	0501-002080	TR-SMALL SIGNAL	2SC2412K,NPN,200mW,SC-59,TP,120-270	
Q951	0501-002080	TR-SMALL SIGNAL	2SC2412K,NPN,200mW,SC-59,TP,120-270	
Q952	0501-002080	TR-SMALL SIGNAL	2SC2412K,NPN,200mW,SC-59,TP,120-270	

Loc. No.	Code No.	Description	Specification	Remarks
Q953	0501-002080	TR-SMALL SIGNAL	2SC2412K,NPN,200mW,SC-59,TP,120-270	
Q954	0501-002080	TR-SMALL SIGNAL	2SC2412K,NPN,200mW,SC-59,TP,120-270	
Q955	0501-002080	TR-SMALL SIGNAL	2SC2412K,NPN,200mW,SC-59,TP,120-270	
Q956	0501-002080	TR-SMALL SIGNAL	2SC2412K,NPN,200mW,SC-59,TP,120-270	
R1	2007-000070	R-CHIP	0ohm,5%,1/16W,DA,TP,1608	
R10	2007-000074	R-CHIP	100ohm,5%,1/16W,DA,TP,1608	
R1001	2007-000084	R-CHIP	4.7Kohm,5%,1/16W,DA,TP,1608	
R1002	2007-000084	R-CHIP	4.7Kohm,5%,1/16W,DA,TP,1608	
R1003	2007-000074	R-CHIP	100ohm,5%,1/16W,DA,TP,1608	
R1004	2007-000090	R-CHIP	10KOHM,5%,1/16W,DA,TP,1608	
R1005	2007-000090	R-CHIP	10KOHM,5%,1/16W,DA,TP,1608	
R1006	2007-000071	R-CHIP	22ohm,5%,1/16W,DA,TP,1608	
R1007	2007-000071	R-CHIP	22ohm,5%,1/16W,DA,TP,1608	
R1008	2007-000071	R-CHIP	22ohm,5%,1/16W,DA,TP,1608	
R1009	2007-001167	R-CHIP	75ohm,5%,1/16W,DA,TP,1608	
R101	2007-000090	R-CHIP	10KOHM,5%,1/16W,DA,TP,1608	
R1010	2007-000071	R-CHIP	22ohm,5%,1/16W,DA,TP,1608	
R1011	2007-001167	R-CHIP	75ohm,5%,1/16W,DA,TP,1608	
R1012	2007-000071	R-CHIP	22ohm,5%,1/16W,DA,TP,1608	
R1013	2007-001167	R-CHIP	75ohm,5%,1/16W,DA,TP,1608	
R1014	2007-001167	R-CHIP	75ohm,5%,1/16W,DA,TP,1608	
R1015	2007-001167	R-CHIP	75ohm,5%,1/16W,DA,TP,1608	
R1016	2007-001167	R-CHIP	75ohm,5%,1/16W,DA,TP,1608	
R1017	2007-001167	R-CHIP	75ohm,5%,1/16W,DA,TP,1608	
R1018	2007-001167	R-CHIP	75ohm,5%,1/16W,DA,TP,1608	
R1019	2007-001167	R-CHIP	75ohm,5%,1/16W,DA,TP,1608	
R102	2007-000084	R-CHIP	4.7Kohm,5%,1/16W,DA,TP,1608	
R1020	2007-001167	R-CHIP	75ohm,5%,1/16W,DA,TP,1608	
R1021	2007-001167	R-CHIP	75ohm,5%,1/16W,DA,TP,1608	
R1022	2007-001167	R-CHIP	75ohm,5%,1/16W,DA,TP,1608	
R1023	2007-001167	R-CHIP	75ohm,5%,1/16W,DA,TP,1608	
R1024	2007-001167	R-CHIP	75ohm,5%,1/16W,DA,TP,1608	
R1025	2007-000071	R-CHIP	22ohm,5%,1/16W,DA,TP,1608	
R1026	2007-000071	R-CHIP	22ohm,5%,1/16W,DA,TP,1608	
R1027	2007-001167	R-CHIP	75ohm,5%,1/16W,DA,TP,1608	
R1028	2007-000071	R-CHIP	22ohm,5%,1/16W,DA,TP,1608	
R1029	2007-000071	R-CHIP	22ohm,5%,1/16W,DA,TP,1608	
R103	2007-000092	R-CHIP	15Kohm,5%,1/16W,DA,TP,1608	
R1030	2007-001167	R-CHIP	75ohm,5%,1/16W,DA,TP,1608	
R1031	2007-000071	R-CHIP	22ohm,5%,1/16W,DA,TP,1608	
R1032	2007-000071	R-CHIP	22ohm,5%,1/16W,DA,TP,1608	
R1033	2007-000071	R-CHIP	22ohm,5%,1/16W,DA,TP,1608	
R1034	2007-000071	R-CHIP	22ohm,5%,1/16W,DA,TP,1608	
R104	2007-000070	R-CHIP	0ohm,5%,1/16W,DA,TP,1608	
R105	2007-000084	R-CHIP	4.7Kohm,5%,1/16W,DA,TP,1608	
R1051	2007-000074	R-CHIP	100ohm,5%,1/16W,DA,TP,1608	
R1052	2007-000074	R-CHIP	100ohm,5%,1/16W,DA,TP,1608	
R106	2007-000084	R-CHIP	4.7Kohm,5%,1/16W,DA,TP,1608	
R107	2007-000084	R-CHIP	4.7Kohm,5%,1/16W,DA,TP,1608	
R108	2007-000084	R-CHIP	4.7Kohm,5%,1/16W,DA,TP,1608	
R109	2007-000084	R-CHIP	4.7Kohm,5%,1/16W,DA,TP,1608	
R11	2007-001167	R-CHIP	75ohm,5%,1/16W,DA,TP,1608	
R110	2007-000084	R-CHIP	4.7Kohm,5%,1/16W,DA,TP,1608	
R111	2007-000084	R-CHIP	4.7Kohm,5%,1/16W,DA,TP,1608	
R112	2007-000084	R-CHIP	4.7Kohm,5%,1/16W,DA,TP,1608	
R113	2007-000070	R-CHIP	0ohm,5%,1/16W,DA,TP,1608	
R114	2007-000239	R-CHIP	1.5Kohm,1%,1/16W,DA,TP,1608	
R115	2007-000239	R-CHIP	1.5Kohm,1%,1/16W,DA,TP,1608	
R116	2007-000070	R-CHIP	0ohm,5%,1/16W,DA,TP,1608	
R117	2007-000075	R-CHIP	220ohm,5%,1/16W,DA,TP,1608	
R118	2007-000075	R-CHIP	220ohm,5%,1/16W,DA,TP,1608	
R119	2007-000070	R-CHIP	0ohm,5%,1/16W,DA,TP,1608	
R12	2007-001167	R-CHIP	75ohm,5%,1/16W,DA,TP,1608	
R120	2007-000070	R-CHIP	0ohm,5%,1/16W,DA,TP,1608	
R121	2007-000090	R-CHIP	10KOHM,5%,1/16W,DA,TP,1608	
R122	2007-000071	R-CHIP	22ohm,5%,1/16W,DA,TP,1608	
R123	2007-000071	R-CHIP	22ohm,5%,1/16W,DA,TP,1608	
R124	2007-000075	R-CHIP	220ohm,5%,1/16W,DA,TP,1608	
R125	2007-000075	R-CHIP	220ohm,5%,1/16W,DA,TP,1608	
R126	2007-000078	R-CHIP	1Kohm,5%,1/16W,DA,TP,1608	

Loc. No.	Code No.	Description	Specification	Remarks
R127	2007-000078	R-CHIP	1Kohm,5%,1/16W,DA,TP,1608	
R1277	2007-000084	R-CHIP	4.7Kohm,5%,1/16W,DA,TP,1608	
R1278	2007-000090	R-CHIP	10KOHM,5%,1/16W,DA,TP,1608	
R128	2007-000070	R-CHIP	0ohm,5%,1/16W,DA,TP,1608	
R129	2007-000084	R-CHIP	4.7Kohm,5%,1/16W,DA,TP,1608	
R13	2007-001167	R-CHIP	75ohm,5%,1/16W,DA,TP,1608	
R130	2007-000070	R-CHIP	0ohm,5%,1/16W,DA,TP,1608	
R131	2007-000084	R-CHIP	4.7Kohm,5%,1/16W,DA,TP,1608	
R132	2007-000084	R-CHIP	4.7Kohm,5%,1/16W,DA,TP,1608	
R134	2007-000084	R-CHIP	4.7Kohm,5%,1/16W,DA,TP,1608	
R136	2007-000084	R-CHIP	4.7Kohm,5%,1/16W,DA,TP,1608	
R137	2007-000084	R-CHIP	4.7Kohm,5%,1/16W,DA,TP,1608	
R138	2007-000084	R-CHIP	4.7Kohm,5%,1/16W,DA,TP,1608	
R139	2007-000084	R-CHIP	4.7Kohm,5%,1/16W,DA,TP,1608	
R14	2007-000097	R-CHIP	47Kohm,5%,1/16W,DA,TP,1608	
R142	2007-000071	R-CHIP	22ohm,5%,1/16W,DA,TP,1608	
R143	2007-000071	R-CHIP	22ohm,5%,1/16W,DA,TP,1608	
R15	2007-000078	R-CHIP	1Kohm,5%,1/16W,DA,TP,1608	
R16	2007-000084	R-CHIP	4.7Kohm,5%,1/16W,DA,TP,1608	
R17	2007-000074	R-CHIP	100ohm,5%,1/16W,DA,TP,1608	
R18	2007-000102	R-CHIP	100Kohm,5%,1/16W,DA,TP,1608	
R19	2007-000074	R-CHIP	100ohm,5%,1/16W,DA,TP,1608	
R190	2007-000071	R-CHIP	22ohm,5%,1/16W,DA,TP,1608	
R191	2007-000071	R-CHIP	22ohm,5%,1/16W,DA,TP,1608	
R192	2007-000070	R-CHIP	0ohm,5%,1/16W,DA,TP,1608	
R193	2007-000070	R-CHIP	0ohm,5%,1/16W,DA,TP,1608	
R194	2007-000070	R-CHIP	0ohm,5%,1/16W,DA,TP,1608	
R195	2007-000070	R-CHIP	0ohm,5%,1/16W,DA,TP,1608	
R2	2007-000070	R-CHIP	0ohm,5%,1/16W,DA,TP,1608	
R20	2007-000072	R-CHIP	47ohm,5%,1/16W,DA,TP,1608	
R2000	2007-000070	R-CHIP	0ohm,5%,1/16W,DA,TP,1608	
R201	2007-000102	R-CHIP	100Kohm,5%,1/16W,DA,TP,1608	
R202	2007-000133	R-CHIP	330Kohm,5%,1/16W,DA,TP,1608	
R203	2007-000102	R-CHIP	100Kohm,5%,1/16W,DA,TP,1608	
R204	2007-000133	R-CHIP	330Kohm,5%,1/16W,DA,TP,1608	
R205	2007-000071	R-CHIP	22ohm,5%,1/16W,DA,TP,1608	
R206	2007-000071	R-CHIP	22ohm,5%,1/16W,DA,TP,1608	
R207	2007-000071	R-CHIP	22ohm,5%,1/16W,DA,TP,1608	
R208	2007-000071	R-CHIP	22ohm,5%,1/16W,DA,TP,1608	
R209	2007-000074	R-CHIP	100ohm,5%,1/16W,DA,TP,1608	
R21	2007-000097	R-CHIP	47Kohm,5%,1/16W,DA,TP,1608	
R210	2007-000074	R-CHIP	100ohm,5%,1/16W,DA,TP,1608	
R211	2007-000090	R-CHIP	10KOHM,5%,1/16W,DA,TP,1608	
R212	2007-000309	R-CHIP	10ohm,5%,1/16W,DA,TP,1608	
R213	2007-000309	R-CHIP	10ohm,5%,1/16W,DA,TP,1608	
R214	2007-000090	R-CHIP	10KOHM,5%,1/16W,DA,TP,1608	
R215	2007-000309	R-CHIP	10ohm,5%,1/16W,DA,TP,1608	
R216	2007-000309	R-CHIP	10ohm,5%,1/16W,DA,TP,1608	
R217	2007-000070	R-CHIP	0ohm,5%,1/16W,DA,TP,1608	
R218	2007-000070	R-CHIP	0ohm,5%,1/16W,DA,TP,1608	
R219	2007-000070	R-CHIP	0ohm,5%,1/16W,DA,TP,1608	
R22	2007-000097	R-CHIP	47Kohm,5%,1/16W,DA,TP,1608	
R220	2007-000309	R-CHIP	10ohm,5%,1/16W,DA,TP,1608	
R221	2007-000309	R-CHIP	10ohm,5%,1/16W,DA,TP,1608	
R222	2007-000309	R-CHIP	10ohm,5%,1/16W,DA,TP,1608	
R223	2007-000309	R-CHIP	10ohm,5%,1/16W,DA,TP,1608	
R224	2007-000074	R-CHIP	100ohm,5%,1/16W,DA,TP,1608	
R225	2007-000074	R-CHIP	100ohm,5%,1/16W,DA,TP,1608	
R226	2007-000082	R-CHIP	3.3Kohm,5%,1/16W,DA,TP,1608	
R227	2007-000078	R-CHIP	1Kohm,5%,1/16W,DA,TP,1608	
R228	2007-001002	R-CHIP	510ohm,5%,1/16W,DA,TP,1608	
R229	2007-000074	R-CHIP	100ohm,5%,1/16W,DA,TP,1608	
R23	2007-000077	R-CHIP	470ohm,5%,1/16W,DA,TP,1608	
R230	2007-000074	R-CHIP	100ohm,5%,1/16W,DA,TP,1608	
R231	2007-000071	R-CHIP	22ohm,5%,1/16W,DA,TP,1608	
R232	2007-000071	R-CHIP	22ohm,5%,1/16W,DA,TP,1608	
R233	2007-000071	R-CHIP	22ohm,5%,1/16W,DA,TP,1608	
R234	2007-000799	R-CHIP	360ohm,5%,1/16W,DA,TP,1608	
R235	2007-001167	R-CHIP	75ohm,5%,1/16W,DA,TP,1608	
R236	2007-001167	R-CHIP	75ohm,5%,1/16W,DA,TP,1608	

Loc. No.	Code No.	Description	Specification	Remarks
R237	2007-001167	R-CHIP	75ohm,5%,1/16W,DA,TP,1608	
R24	2007-000078	R-CHIP	1Kohm,5%,1/16W,DA,TP,1608	
R241	2007-000070	R-CHIP	0ohm,5%,1/16W,DA,TP,1608	
R242	2007-000070	R-CHIP	0ohm,5%,1/16W,DA,TP,1608	
R243	2007-000070	R-CHIP	0ohm,5%,1/16W,DA,TP,1608	
R244	2007-000070	R-CHIP	0ohm,5%,1/16W,DA,TP,1608	
R245	2007-000070	R-CHIP	0ohm,5%,1/16W,DA,TP,1608	
R246	2007-000084	R-CHIP	4.7Kohm,5%,1/16W,DA,TP,1608	
R247	2007-000084	R-CHIP	4.7Kohm,5%,1/16W,DA,TP,1608	
R248	2007-000102	R-CHIP	100Kohm,5%,1/16W,DA,TP,1608	
R249	2007-000133	R-CHIP	330Kohm,5%,1/16W,DA,TP,1608	
R25	2007-000084	R-CHIP	4.7Kohm,5%,1/16W,DA,TP,1608	
R250	2007-000071	R-CHIP	22ohm,5%,1/16W,DA,TP,1608	
R251	2007-000071	R-CHIP	22ohm,5%,1/16W,DA,TP,1608	
R252	2007-000071	R-CHIP	22ohm,5%,1/16W,DA,TP,1608	
R253	2007-000071	R-CHIP	22ohm,5%,1/16W,DA,TP,1608	
R26	2007-000132	R-CHIP	180Kohm,5%,1/16W,DA,TP,1608	
R27	2007-000124	R-CHIP	2.2Kohm,5%,1/16W,DA,TP,1608	
R28	2007-000077	R-CHIP	470ohm,5%,1/16W,DA,TP,1608	
R29	2007-000119	R-CHIP	560ohm,5%,1/16W,DA,TP,1608	
R298	2007-000070	R-CHIP	0ohm,5%,1/16W,DA,TP,1608	
R299	2007-000070	R-CHIP	0ohm,5%,1/16W,DA,TP,1608	
R3	2007-000070	R-CHIP	0ohm,5%,1/16W,DA,TP,1608	
R30	2007-001167	R-CHIP	75ohm,5%,1/16W,DA,TP,1608	
R301	2007-000078	R-CHIP	1Kohm,5%,1/16W,DA,TP,1608	
R303	2007-000078	R-CHIP	1Kohm,5%,1/16W,DA,TP,1608	
R304	2007-000078	R-CHIP	1Kohm,5%,1/16W,DA,TP,1608	
R305	2007-000070	R-CHIP	0ohm,5%,1/16W,DA,TP,1608	
R306	2007-000070	R-CHIP	0ohm,5%,1/16W,DA,TP,1608	
R307	2007-000070	R-CHIP	0ohm,5%,1/16W,DA,TP,1608	
R308	2007-000070	R-CHIP	0ohm,5%,1/16W,DA,TP,1608	
R309	2007-000070	R-CHIP	0ohm,5%,1/16W,DA,TP,1608	
R31	2007-000074	R-CHIP	100ohm,5%,1/16W,DA,TP,1608	
R310	2007-000070	R-CHIP	0ohm,5%,1/16W,DA,TP,1608	
R311	2007-000070	R-CHIP	0ohm,5%,1/16W,DA,TP,1608	
R312	2007-000070	R-CHIP	0ohm,5%,1/16W,DA,TP,1608	
R313	2007-000070	R-CHIP	0ohm,5%,1/16W,DA,TP,1608	
R316	2007-000074	R-CHIP	100ohm,5%,1/16W,DA,TP,1608	
R32	2007-000075	R-CHIP	220ohm,5%,1/16W,DA,TP,1608	
R320	2007-000070	R-CHIP	0ohm,5%,1/16W,DA,TP,1608	
R321	2007-000070	R-CHIP	0ohm,5%,1/16W,DA,TP,1608	
R322	2007-000070	R-CHIP	0ohm,5%,1/16W,DA,TP,1608	
R323	2007-000070	R-CHIP	0ohm,5%,1/16W,DA,TP,1608	
R324	2007-000074	R-CHIP	100ohm,5%,1/16W,DA,TP,1608	
R325	2007-000070	R-CHIP	0ohm,5%,1/16W,DA,TP,1608	
R326	2007-000074	R-CHIP	100ohm,5%,1/16W,DA,TP,1608	
R327	2007-000070	R-CHIP	0ohm,5%,1/16W,DA,TP,1608	
R328	2007-000402	R-CHIP	150ohm,5%,1/16W,DA,TP,1608	
R329	2007-000075	R-CHIP	220ohm,5%,1/16W,DA,TP,1608	
R33	2007-000070	R-CHIP	0ohm,5%,1/16W,DA,TP,1608	
R330	2007-000078	R-CHIP	1Kohm,5%,1/16W,DA,TP,1608	
R331	2007-000070	R-CHIP	0ohm,5%,1/16W,DA,TP,1608	
R332	2007-000074	R-CHIP	100ohm,5%,1/16W,DA,TP,1608	
R333	2007-000070	R-CHIP	0ohm,5%,1/16W,DA,TP,1608	
R334	2007-000074	R-CHIP	100ohm,5%,1/16W,DA,TP,1608	
R335	2007-000074	R-CHIP	100ohm,5%,1/16W,DA,TP,1608	
R336	2007-000070	R-CHIP	0ohm,5%,1/16W,DA,TP,1608	
R337	2007-000070	R-CHIP	0ohm,5%,1/16W,DA,TP,1608	
R338	2007-000070	R-CHIP	0ohm,5%,1/16W,DA,TP,1608	
R339	2007-000070	R-CHIP	0ohm,5%,1/16W,DA,TP,1608	
R34	2007-000309	R-CHIP	10ohm,5%,1/16W,DA,TP,1608	
R340	2007-000074	R-CHIP	100ohm,5%,1/16W,DA,TP,1608	
R342	2007-001167	R-CHIP	75ohm,5%,1/16W,DA,TP,1608	
R343	2007-001167	R-CHIP	75ohm,5%,1/16W,DA,TP,1608	
R344	2007-001167	R-CHIP	75ohm,5%,1/16W,DA,TP,1608	
R345	2007-000070	R-CHIP	0ohm,5%,1/16W,DA,TP,1608	
R346	2007-000070	R-CHIP	0ohm,5%,1/16W,DA,TP,1608	
R347	2007-001167	R-CHIP	75ohm,5%,1/16W,DA,TP,1608	
R35	2007-000402	R-CHIP	150ohm,5%,1/16W,DA,TP,1608	
R352	2007-000402	R-CHIP	150ohm,5%,1/16W,DA,TP,1608	

Loc. No.	Code No.	Description	Specification	Remarks
R353	2007-001167	R-CHIP	75ohm,5%,1/16W,DA,TP,1608	
R354	2007-000084	R-CHIP	4.7Kohm,5%,1/16W,DA,TP,1608	
R355	2007-000113	R-CHIP	33ohm,5%,1/16W,DA,TP,1608	
R356	2007-000113	R-CHIP	33ohm,5%,1/16W,DA,TP,1608	
R357	2007-000113	R-CHIP	33ohm,5%,1/16W,DA,TP,1608	
R358	2007-000070	R-CHIP	0ohm,5%,1/16W,DA,TP,1608	
R359	2007-000070	R-CHIP	0ohm,5%,1/16W,DA,TP,1608	
R36	2007-000077	R-CHIP	470ohm,5%,1/16W,DA,TP,1608	
R361	2007-000107	R-CHIP	470Kohm,5%,1/16W,DA,TP,1608	
R364	2007-000070	R-CHIP	0ohm,5%,1/16W,DA,TP,1608	
R368	2007-000070	R-CHIP	0ohm,5%,1/16W,DA,TP,1608	
R37	2007-000077	R-CHIP	470ohm,5%,1/16W,DA,TP,1608	
R371	2007-000074	R-CHIP	100ohm,5%,1/16W,DA,TP,1608	
R372	2007-000070	R-CHIP	0ohm,5%,1/16W,DA,TP,1608	
R375	2007-000090	R-CHIP	10KOHM,5%,1/16W,DA,TP,1608	
R376	2007-000113	R-CHIP	33ohm,5%,1/16W,DA,TP,1608	
R377	2007-000113	R-CHIP	33ohm,5%,1/16W,DA,TP,1608	
R378	2007-000113	R-CHIP	33ohm,5%,1/16W,DA,TP,1608	
R38	2007-000070	R-CHIP	0ohm,5%,1/16W,DA,TP,1608	
R39	2007-000075	R-CHIP	220ohm,5%,1/16W,DA,TP,1608	
R4	2007-000074	R-CHIP	100ohm,5%,1/16W,DA,TP,1608	
R40	2007-000075	R-CHIP	220ohm,5%,1/16W,DA,TP,1608	
R401	2007-000102	R-CHIP	100Kohm,5%,1/16W,DA,TP,1608	
R402	2007-000133	R-CHIP	330Kohm,5%,1/16W,DA,TP,1608	
R403	2007-000102	R-CHIP	100Kohm,5%,1/16W,DA,TP,1608	
R404	2007-000133	R-CHIP	330Kohm,5%,1/16W,DA,TP,1608	
R405	2007-000070	R-CHIP	0ohm,5%,1/16W,DA,TP,1608	
R406	2007-000070	R-CHIP	0ohm,5%,1/16W,DA,TP,1608	
R407	2007-000070	R-CHIP	0ohm,5%,1/16W,DA,TP,1608	
R408	2007-000113	R-CHIP	33ohm,5%,1/16W,DA,TP,1608	
R409	2007-000113	R-CHIP	33ohm,5%,1/16W,DA,TP,1608	
R41	2007-000086	R-CHIP	5.6Kohm,5%,1/16W,DA,TP,1608	
R410	2007-000113	R-CHIP	33ohm,5%,1/16W,DA,TP,1608	
R411	2007-000070	R-CHIP	0ohm,5%,1/16W,DA,TP,1608	
R412	2007-001167	R-CHIP	75ohm,5%,1/16W,DA,TP,1608	
R413	2007-001167	R-CHIP	75ohm,5%,1/16W,DA,TP,1608	
R414	2007-001167	R-CHIP	75ohm,5%,1/16W,DA,TP,1608	
R415	2007-000090	R-CHIP	10KOHM,5%,1/16W,DA,TP,1608	
R416	2007-000107	R-CHIP	470Kohm,5%,1/16W,DA,TP,1608	
R417	2007-000074	R-CHIP	100ohm,5%,1/16W,DA,TP,1608	
R418	2007-000070	R-CHIP	0ohm,5%,1/16W,DA,TP,1608	
R419	2007-000074	R-CHIP	100ohm,5%,1/16W,DA,TP,1608	
R42	2007-000070	R-CHIP	0ohm,5%,1/16W,DA,TP,1608	
R420	2007-000070	R-CHIP	0ohm,5%,1/16W,DA,TP,1608	
R421	2007-000074	R-CHIP	100ohm,5%,1/16W,DA,TP,1608	
R422	2007-000070	R-CHIP	0ohm,5%,1/16W,DA,TP,1608	
R423	2007-000090	R-CHIP	10KOHM,5%,1/16W,DA,TP,1608	
R424	2007-000070	R-CHIP	0ohm,5%,1/16W,DA,TP,1608	
R425	2007-000070	R-CHIP	0ohm,5%,1/16W,DA,TP,1608	
R426	2007-000070	R-CHIP	0ohm,5%,1/16W,DA,TP,1608	
R427	2007-000113	R-CHIP	33ohm,5%,1/16W,DA,TP,1608	
R428	2007-000113	R-CHIP	33ohm,5%,1/16W,DA,TP,1608	
R429	2007-000113	R-CHIP	33ohm,5%,1/16W,DA,TP,1608	
R43	2007-000070	R-CHIP	0ohm,5%,1/16W,DA,TP,1608	
R430	2007-001167	R-CHIP	75ohm,5%,1/16W,DA,TP,1608	
R431	2007-001167	R-CHIP	75ohm,5%,1/16W,DA,TP,1608	
R432	2007-001167	R-CHIP	75ohm,5%,1/16W,DA,TP,1608	
R433	2007-000082	R-CHIP	3.3Kohm,5%,1/16W,DA,TP,1608	
R44	2007-000077	R-CHIP	470ohm,5%,1/16W,DA,TP,1608	
R45	2007-000078	R-CHIP	1Kohm,5%,1/16W,DA,TP,1608	
R46	2007-000070	R-CHIP	0ohm,5%,1/16W,DA,TP,1608	
R462	2007-000070	R-CHIP	0ohm,5%,1/16W,DA,TP,1608	
R47	2007-000072	R-CHIP	47ohm,5%,1/16W,DA,TP,1608	
R48	2007-000077	R-CHIP	470ohm,5%,1/16W,DA,TP,1608	
R49	2007-000078	R-CHIP	1Kohm,5%,1/16W,DA,TP,1608	
R5	2007-000070	R-CHIP	0ohm,5%,1/16W,DA,TP,1608	
R50	2007-000084	R-CHIP	4.7Kohm,5%,1/16W,DA,TP,1608	
R501	2007-000074	R-CHIP	100ohm,5%,1/16W,DA,TP,1608	
R502	2007-000074	R-CHIP	100ohm,5%,1/16W,DA,TP,1608	
R503	2007-000074	R-CHIP	100ohm,5%,1/16W,DA,TP,1608	

Loc. No.	Code No.	Description	Specification	Remarks
R504	2007-000074	R-CHIP	100ohm,5%,1/16W,DA,TP,1608	
R505	2007-000074	R-CHIP	100ohm,5%,1/16W,DA,TP,1608	
R506	2007-000074	R-CHIP	100ohm,5%,1/16W,DA,TP,1608	
R507	2007-000074	R-CHIP	100ohm,5%,1/16W,DA,TP,1608	
R508	2007-000074	R-CHIP	100ohm,5%,1/16W,DA,TP,1608	
R509	2007-000074	R-CHIP	100ohm,5%,1/16W,DA,TP,1608	
R51	2007-000119	R-CHIP	560ohm,5%,1/16W,DA,TP,1608	
R510	2007-000074	R-CHIP	100ohm,5%,1/16W,DA,TP,1608	
R511	2007-000309	R-CHIP	10ohm,5%,1/16W,DA,TP,1608	
R512	2007-000086	R-CHIP	5.6Kohm,5%,1/16W,DA,TP,1608	
R513	2007-000081	R-CHIP	2.7Kohm,5%,1/16W,DA,TP,1608	
R514	2007-000076	R-CHIP	330ohm,5%,1/16W,DA,TP,1608	
R515	2007-000084	R-CHIP	4.7Kohm,5%,1/16W,DA,TP,1608	
R516	2007-000093	R-CHIP	20Kohm,5%,1/16W,DA,TP,1608	
R517	2007-000074	R-CHIP	100ohm,5%,1/16W,DA,TP,1608	
R518	2007-000093	R-CHIP	20Kohm,5%,1/16W,DA,TP,1608	
R519	2007-000076	R-CHIP	330ohm,5%,1/16W,DA,TP,1608	
R52	2007-001167	R-CHIP	75ohm,5%,1/16W,DA,TP,1608	
R520	2007-000109	R-CHIP	1Mohm,5%,1/16W,DA,TP,1608	
R521	2007-000084	R-CHIP	4.7Kohm,5%,1/16W,DA,TP,1608	
R522	2007-000076	R-CHIP	330ohm,5%,1/16W,DA,TP,1608	
R523	2007-000309	R-CHIP	10ohm,5%,1/16W,DA,TP,1608	
R524	2007-000078	R-CHIP	1Kohm,5%,1/16W,DA,TP,1608	
R525	2007-000074	R-CHIP	100ohm,5%,1/16W,DA,TP,1608	
R526	2007-000074	R-CHIP	100ohm,5%,1/16W,DA,TP,1608	
R527	2007-000074	R-CHIP	100ohm,5%,1/16W,DA,TP,1608	
R528	2007-000084	R-CHIP	4.7Kohm,5%,1/16W,DA,TP,1608	
R529	2007-000074	R-CHIP	100ohm,5%,1/16W,DA,TP,1608	
R53	2007-000309	R-CHIP	10ohm,5%,1/16W,DA,TP,1608	
R530	2007-000074	R-CHIP	100ohm,5%,1/16W,DA,TP,1608	
R531	2007-000084	R-CHIP	4.7Kohm,5%,1/16W,DA,TP,1608	
R532	2007-000090	R-CHIP	10KOHM,5%,1/16W,DA,TP,1608	
R533	2007-000309	R-CHIP	10ohm,5%,1/16W,DA,TP,1608	
R534	2007-000084	R-CHIP	4.7Kohm,5%,1/16W,DA,TP,1608	
R535	2007-000084	R-CHIP	4.7Kohm,5%,1/16W,DA,TP,1608	
R536	2007-000309	R-CHIP	10ohm,5%,1/16W,DA,TP,1608	
R537	2007-000078	R-CHIP	1Kohm,5%,1/16W,DA,TP,1608	
R538	2007-000078	R-CHIP	1Kohm,5%,1/16W,DA,TP,1608	
R539	2007-000090	R-CHIP	10KOHM,5%,1/16W,DA,TP,1608	
R54	2007-000077	R-CHIP	470ohm,5%,1/16W,DA,TP,1608	
R540	2007-000090	R-CHIP	10KOHM,5%,1/16W,DA,TP,1608	
R541	2007-000090	R-CHIP	10KOHM,5%,1/16W,DA,TP,1608	
R542	2007-000090	R-CHIP	10KOHM,5%,1/16W,DA,TP,1608	
R543	2007-000078	R-CHIP	1Kohm,5%,1/16W,DA,TP,1608	
R544	2007-000078	R-CHIP	1Kohm,5%,1/16W,DA,TP,1608	
R545	2007-000078	R-CHIP	1Kohm,5%,1/16W,DA,TP,1608	
R546	2007-000078	R-CHIP	1Kohm,5%,1/16W,DA,TP,1608	
R547	2007-000078	R-CHIP	1Kohm,5%,1/16W,DA,TP,1608	
R548	2007-000078	R-CHIP	1Kohm,5%,1/16W,DA,TP,1608	
R55	2007-000077	R-CHIP	470ohm,5%,1/16W,DA,TP,1608	
R56	2007-000075	R-CHIP	220ohm,5%,1/16W,DA,TP,1608	
R57	2007-000086	R-CHIP	5.6Kohm,5%,1/16W,DA,TP,1608	
R58	2007-000070	R-CHIP	0ohm,5%,1/16W,DA,TP,1608	
R59	2007-000070	R-CHIP	0ohm,5%,1/16W,DA,TP,1608	
R6	2007-000070	R-CHIP	0ohm,5%,1/16W,DA,TP,1608	
R60	2007-000070	R-CHIP	0ohm,5%,1/16W,DA,TP,1608	
R601	2007-000090	R-CHIP	10KOHM,5%,1/16W,DA,TP,1608	
R602	2007-000071	R-CHIP	22ohm,5%,1/16W,DA,TP,1608	
R603	2007-000090	R-CHIP	10KOHM,5%,1/16W,DA,TP,1608	
R604	2007-000084	R-CHIP	4.7Kohm,5%,1/16W,DA,TP,1608	
R605	2007-000090	R-CHIP	10KOHM,5%,1/16W,DA,TP,1608	
R606	2007-000071	R-CHIP	22ohm,5%,1/16W,DA,TP,1608	
R607	2007-000090	R-CHIP	10KOHM,5%,1/16W,DA,TP,1608	
R608	2007-000090	R-CHIP	10KOHM,5%,1/16W,DA,TP,1608	
R609	2007-000070	R-CHIP	0ohm,5%,1/16W,DA,TP,1608	
R61	2007-000070	R-CHIP	0ohm,5%,1/16W,DA,TP,1608	
R610	2007-000070	R-CHIP	0ohm,5%,1/16W,DA,TP,1608	
R611	2007-000070	R-CHIP	0ohm,5%,1/16W,DA,TP,1608	
R612	2007-000070	R-CHIP	0ohm,5%,1/16W,DA,TP,1608	
R613	2007-000071	R-CHIP	22ohm,5%,1/16W,DA,TP,1608	



Loc. No.	Code No.	Description	Specification	Remarks
R614	2007-000071	R-CHIP	22ohm,5%,1/16W,DA,TP,1608	
R615	2007-000071	R-CHIP	22ohm,5%,1/16W,DA,TP,1608	
R616	2007-000071	R-CHIP	22ohm,5%,1/16W,DA,TP,1608	
R617	2007-000071	R-CHIP	22ohm,5%,1/16W,DA,TP,1608	
R618	2007-000070	R-CHIP	0ohm,5%,1/16W,DA,TP,1608	
R619	2007-000070	R-CHIP	0ohm,5%,1/16W,DA,TP,1608	
R62	2007-000070	R-CHIP	0ohm,5%,1/16W,DA,TP,1608	
R620	2007-000070	R-CHIP	0ohm,5%,1/16W,DA,TP,1608	
R621	2007-000070	R-CHIP	0ohm,5%,1/16W,DA,TP,1608	
R622	2007-000074	R-CHIP	100ohm,5%,1/16W,DA,TP,1608	
R623	2007-000074	R-CHIP	100ohm,5%,1/16W,DA,TP,1608	
R624	2007-000074	R-CHIP	100ohm,5%,1/16W,DA,TP,1608	
R625	2007-000071	R-CHIP	22ohm,5%,1/16W,DA,TP,1608	
R626	2007-000074	R-CHIP	100ohm,5%,1/16W,DA,TP,1608	
R627	2007-000071	R-CHIP	22ohm,5%,1/16W,DA,TP,1608	
R628	2007-000074	R-CHIP	100ohm,5%,1/16W,DA,TP,1608	
R629	2007-000071	R-CHIP	22ohm,5%,1/16W,DA,TP,1608	
R63	2007-000074	R-CHIP	100ohm,5%,1/16W,DA,TP,1608	
R630	2007-000071	R-CHIP	22ohm,5%,1/16W,DA,TP,1608	
R631	2007-000074	R-CHIP	100ohm,5%,1/16W,DA,TP,1608	
R632	2007-000071	R-CHIP	22ohm,5%,1/16W,DA,TP,1608	
R633	2007-000071	R-CHIP	22ohm,5%,1/16W,DA,TP,1608	
R634	2007-000074	R-CHIP	100ohm,5%,1/16W,DA,TP,1608	
R635	2007-000071	R-CHIP	22ohm,5%,1/16W,DA,TP,1608	
R636	2007-000071	R-CHIP	22ohm,5%,1/16W,DA,TP,1608	
R637	2007-000071	R-CHIP	22ohm,5%,1/16W,DA,TP,1608	
R638	2007-000070	R-CHIP	0ohm,5%,1/16W,DA,TP,1608	
R639	2007-000070	R-CHIP	0ohm,5%,1/16W,DA,TP,1608	
R64	2007-000070	R-CHIP	0ohm,5%,1/16W,DA,TP,1608	
R640	2007-000070	R-CHIP	0ohm,5%,1/16W,DA,TP,1608	
R641	2007-000070	R-CHIP	0ohm,5%,1/16W,DA,TP,1608	
R642	2007-000070	R-CHIP	0ohm,5%,1/16W,DA,TP,1608	
R643	2007-000070	R-CHIP	0ohm,5%,1/16W,DA,TP,1608	
R644	2007-000070	R-CHIP	0ohm,5%,1/16W,DA,TP,1608	
R645	2007-000070	R-CHIP	0ohm,5%,1/16W,DA,TP,1608	
R646	2007-000071	R-CHIP	22ohm,5%,1/16W,DA,TP,1608	
R647	2007-000071	R-CHIP	22ohm,5%,1/16W,DA,TP,1608	
R648	2007-000071	R-CHIP	22ohm,5%,1/16W,DA,TP,1608	
R649	2007-000071	R-CHIP	22ohm,5%,1/16W,DA,TP,1608	
R65	2007-000070	R-CHIP	0ohm,5%,1/16W,DA,TP,1608	
R650	2007-000071	R-CHIP	22ohm,5%,1/16W,DA,TP,1608	
R651	2007-000071	R-CHIP	22ohm,5%,1/16W,DA,TP,1608	
R652	2007-000074	R-CHIP	100ohm,5%,1/16W,DA,TP,1608	
R653	2007-000074	R-CHIP	100ohm,5%,1/16W,DA,TP,1608	
R654	2007-000084	R-CHIP	4.7Kohm,5%,1/16W,DA,TP,1608	
R655	2007-000071	R-CHIP	22ohm,5%,1/16W,DA,TP,1608	
R656	2007-000071	R-CHIP	22ohm,5%,1/16W,DA,TP,1608	
R659	2007-000071	R-CHIP	22ohm,5%,1/16W,DA,TP,1608	
R66	2007-000070	R-CHIP	0ohm,5%,1/16W,DA,TP,1608	
R660	2007-000074	R-CHIP	100ohm,5%,1/16W,DA,TP,1608	
R67	2007-000070	R-CHIP	0ohm,5%,1/16W,DA,TP,1608	
R68	2007-000134	R-CHIP	33Kohm,5%,1/16W,DA,TP,1608	
R69	2007-000079	R-CHIP	1.8Kohm,5%,1/16W,DA,TP,1608	
R7	2007-000074	R-CHIP	100ohm,5%,1/16W,DA,TP,1608	
R70	2007-000070	R-CHIP	0ohm,5%,1/16W,DA,TP,1608	
R701	2007-000070	R-CHIP	0ohm,5%,1/16W,DA,TP,1608	
R702	2007-000113	R-CHIP	33ohm,5%,1/16W,DA,TP,1608	
R703	2007-000076	R-CHIP	330ohm,5%,1/16W,DA,TP,1608	
R704	2007-000074	R-CHIP	100ohm,5%,1/16W,DA,TP,1608	
R705	2007-000074	R-CHIP	100ohm,5%,1/16W,DA,TP,1608	
R706	2007-000305	R-CHIP	10Mohm,5%,1/16W,DA,TP,1608	
R707	2007-000070	R-CHIP	0ohm,5%,1/16W,DA,TP,1608	
R708	2007-000070	R-CHIP	0ohm,5%,1/16W,DA,TP,1608	
R71	2007-000070	R-CHIP	0ohm,5%,1/16W,DA,TP,1608	
R712	2007-000070	R-CHIP	0ohm,5%,1/16W,DA,TP,1608	
R713	2007-000076	R-CHIP	330ohm,5%,1/16W,DA,TP,1608	
R714	2007-000076	R-CHIP	330ohm,5%,1/16W,DA,TP,1608	
R715	2007-000076	R-CHIP	330ohm,5%,1/16W,DA,TP,1608	
R716	2007-000076	R-CHIP	330ohm,5%,1/16W,DA,TP,1608	
R717	2007-000070	R-CHIP	0ohm,5%,1/16W,DA,TP,1608	

Loc. No.	Code No.	Description	Specification	Remarks
R718	2007-000070	R-CHIP	0ohm,5%,1/16W,DA,TP,1608	
R72	2007-000119	R-CHIP	560ohm,5%,1/16W,DA,TP,1608	
R720	2007-000070	R-CHIP	0ohm,5%,1/16W,DA,TP,1608	
R721	2007-000070	R-CHIP	0ohm,5%,1/16W,DA,TP,1608	
R722	2007-000071	R-CHIP	22ohm,5%,1/16W,DA,TP,1608	
R723	2007-000074	R-CHIP	100ohm,5%,1/16W,DA,TP,1608	
R724	2007-000074	R-CHIP	100ohm,5%,1/16W,DA,TP,1608	
R73	2007-000072	R-CHIP	47ohm,5%,1/16W,DA,TP,1608	
R74	2007-000071	R-CHIP	22ohm,5%,1/16W,DA,TP,1608	
R75	2007-000070	R-CHIP	0ohm,5%,1/16W,DA,TP,1608	
R76	2007-000086	R-CHIP	5.6Kohm,5%,1/16W,DA,TP,1608	
R77	2007-000090	R-CHIP	10KOHM,5%,1/16W,DA,TP,1608	
R78	2007-000077	R-CHIP	470ohm,5%,1/16W,DA,TP,1608	
R79	2007-000077	R-CHIP	470ohm,5%,1/16W,DA,TP,1608	
R8	2007-000070	R-CHIP	0ohm,5%,1/16W,DA,TP,1608	
R80	2007-000070	R-CHIP	0ohm,5%,1/16W,DA,TP,1608	
R801	2007-000090	R-CHIP	10KOHM,5%,1/16W,DA,TP,1608	
R802	2007-000090	R-CHIP	10KOHM,5%,1/16W,DA,TP,1608	
R803	2007-000084	R-CHIP	4.7Kohm,5%,1/16W,DA,TP,1608	
R804	2007-000090	R-CHIP	10KOHM,5%,1/16W,DA,TP,1608	
R805	2007-000071	R-CHIP	22ohm,5%,1/16W,DA,TP,1608	
R806	2007-000090	R-CHIP	10KOHM,5%,1/16W,DA,TP,1608	
R807	2007-000090	R-CHIP	10KOHM,5%,1/16W,DA,TP,1608	
R808	2007-000070	R-CHIP	0ohm,5%,1/16W,DA,TP,1608	
R809	2007-000070	R-CHIP	0ohm,5%,1/16W,DA,TP,1608	
R81	2007-001167	R-CHIP	75ohm,5%,1/16W,DA,TP,1608	
R810	2007-000070	R-CHIP	0ohm,5%,1/16W,DA,TP,1608	
R811	2007-000070	R-CHIP	0ohm,5%,1/16W,DA,TP,1608	
R812	2007-000071	R-CHIP	22ohm,5%,1/16W,DA,TP,1608	
R813	2007-000071	R-CHIP	22ohm,5%,1/16W,DA,TP,1608	
R814	2007-000071	R-CHIP	22ohm,5%,1/16W,DA,TP,1608	
R815	2007-000071	R-CHIP	22ohm,5%,1/16W,DA,TP,1608	
R816	2007-000071	R-CHIP	22ohm,5%,1/16W,DA,TP,1608	
R817	2007-000071	R-CHIP	22ohm,5%,1/16W,DA,TP,1608	
R818	2007-000071	R-CHIP	22ohm,5%,1/16W,DA,TP,1608	
R819	2007-000070	R-CHIP	0ohm,5%,1/16W,DA,TP,1608	
R82	2007-001167	R-CHIP	75ohm,5%,1/16W,DA,TP,1608	
R820	2007-000071	R-CHIP	22ohm,5%,1/16W,DA,TP,1608	
R821	2007-000071	R-CHIP	22ohm,5%,1/16W,DA,TP,1608	
R822	2007-000071	R-CHIP	22ohm,5%,1/16W,DA,TP,1608	
R823	2007-000071	R-CHIP	22ohm,5%,1/16W,DA,TP,1608	
R824	2007-000071	R-CHIP	22ohm,5%,1/16W,DA,TP,1608	
R825	2007-000071	R-CHIP	22ohm,5%,1/16W,DA,TP,1608	
R826	2007-000070	R-CHIP	0ohm,5%,1/16W,DA,TP,1608	
R827	2007-000071	R-CHIP	22ohm,5%,1/16W,DA,TP,1608	
R828	2007-000070	R-CHIP	0ohm,5%,1/16W,DA,TP,1608	
R829	2007-000084	R-CHIP	4.7Kohm,5%,1/16W,DA,TP,1608	
R83	2007-000070	R-CHIP	0ohm,5%,1/16W,DA,TP,1608	
R830	2007-000071	R-CHIP	22ohm,5%,1/16W,DA,TP,1608	
R832	2007-000071	R-CHIP	22ohm,5%,1/16W,DA,TP,1608	
R834	2007-000071	R-CHIP	22ohm,5%,1/16W,DA,TP,1608	
R84	2007-000070	R-CHIP	0ohm,5%,1/16W,DA,TP,1608	
R9	2007-000070	R-CHIP	0ohm,5%,1/16W,DA,TP,1608	
R932	2007-000084	R-CHIP	4.7Kohm,5%,1/16W,DA,TP,1608	
R934	2007-000122	R-CHIP	1.2Kohm,5%,1/16W,DA,TP,1608	
R936	2007-000102	R-CHIP	100Kohm,5%,1/16W,DA,TP,1608	
R937	2007-000093	R-CHIP	20Kohm,5%,1/16W,DA,TP,1608	
R938	2007-007730	R-CHIP	6.8MOHM,1%,1/10W,DA,TP,1608	
R939	2007-000052	R-CHIP	10Kohm,1%,1/16W,DA,TP,1608	
R940	2007-002902	R-CHIP	162Kohm,1%,1/16W,DA,TP,1608	
R941	2007-007730	R-CHIP	6.8MOHM,1%,1/10W,DA,TP,1608	
R942	2007-000070	R-CHIP	0ohm,5%,1/16W,DA,TP,1608	
R950	2007-000077	R-CHIP	470ohm,5%,1/16W,DA,TP,1608	
R951	2007-000084	R-CHIP	4.7Kohm,5%,1/16W,DA,TP,1608	
R952	2007-000084	R-CHIP	4.7Kohm,5%,1/16W,DA,TP,1608	
R953	2007-000077	R-CHIP	470ohm,5%,1/16W,DA,TP,1608	
R954	2007-000084	R-CHIP	4.7Kohm,5%,1/16W,DA,TP,1608	
R955	2007-000074	R-CHIP	100ohm,5%,1/16W,DA,TP,1608	
R956	2007-000090	R-CHIP	10KOHM,5%,1/16W,DA,TP,1608	
R957	2007-000084	R-CHIP	4.7Kohm,5%,1/16W,DA,TP,1608	

Loc. No.	Code No.	Description	Specification	Remarks
R958	2007-000084	R-CHIP	4.7Kohm,5%,1/16W,DA,TP,1608	
R959	2007-000084	R-CHIP	4.7Kohm,5%,1/16W,DA,TP,1608	
R960	2007-000084	R-CHIP	4.7Kohm,5%,1/16W,DA,TP,1608	
R961	2007-000074	R-CHIP	100ohm,5%,1/16W,DA,TP,1608	
R962	2007-000090	R-CHIP	10KOHM,5%,1/16W,DA,TP,1608	
R963	2007-000084	R-CHIP	4.7Kohm,5%,1/16W,DA,TP,1608	
R964	2007-000084	R-CHIP	4.7Kohm,5%,1/16W,DA,TP,1608	
R965	2007-000084	R-CHIP	4.7Kohm,5%,1/16W,DA,TP,1608	
R966	2007-000084	R-CHIP	4.7Kohm,5%,1/16W,DA,TP,1608	
R967	2007-000074	R-CHIP	100ohm,5%,1/16W,DA,TP,1608	
R968	2007-000090	R-CHIP	10KOHM,5%,1/16W,DA,TP,1608	
R969	2007-000077	R-CHIP	470ohm,5%,1/16W,DA,TP,1608	
R970	2007-000084	R-CHIP	4.7Kohm,5%,1/16W,DA,TP,1608	
R971	2007-000077	R-CHIP	470ohm,5%,1/16W,DA,TP,1608	
R972	2007-000084	R-CHIP	4.7Kohm,5%,1/16W,DA,TP,1608	
R973	2007-000074	R-CHIP	100ohm,5%,1/16W,DA,TP,1608	
R974	2007-000090	R-CHIP	10KOHM,5%,1/16W,DA,TP,1608	
R975	2007-000102	R-CHIP	100Kohm,5%,1/16W,DA,TP,1608	
R976	2007-000077	R-CHIP	470ohm,5%,1/16W,DA,TP,1608	
R977	2007-000084	R-CHIP	4.7Kohm,5%,1/16W,DA,TP,1608	
R978	2007-000090	R-CHIP	10KOHM,5%,1/16W,DA,TP,1608	
R979	2007-000102	R-CHIP	100Kohm,5%,1/16W,DA,TP,1608	
R980	2007-000077	R-CHIP	470ohm,5%,1/16W,DA,TP,1608	
R981	2007-000084	R-CHIP	4.7Kohm,5%,1/16W,DA,TP,1608	
R982	2007-000074	R-CHIP	100ohm,5%,1/16W,DA,TP,1608	
R983	2007-000102	R-CHIP	100Kohm,5%,1/16W,DA,TP,1608	
R984	2007-000090	R-CHIP	10KOHM,5%,1/16W,DA,TP,1608	
R985	2007-000090	R-CHIP	10KOHM,5%,1/16W,DA,TP,1608	
R986	2007-000102	R-CHIP	100Kohm,5%,1/16W,DA,TP,1608	
R987	2007-000070	R-CHIP	0ohm,5%,1/16W,DA,TP,1608	
R988	2007-000070	R-CHIP	0ohm,5%,1/16W,DA,TP,1608	
R989	2007-000070	R-CHIP	0ohm,5%,1/16W,DA,TP,1608	
R99	2007-000070	R-CHIP	0ohm,5%,1/16W,DA,TP,1608	
R990	2007-000070	R-CHIP	0ohm,5%,1/16W,DA,TP,1608	
RA201	2011-000002	R-NETWORK	22ohm,5%,63mW,L,CHIP,8P,TP	
RA202	2011-000002	R-NETWORK	22ohm,5%,63mW,L,CHIP,8P,TP	
RA203	2011-000002	R-NETWORK	22ohm,5%,63mW,L,CHIP,8P,TP	
RA204	2011-000002	R-NETWORK	22ohm,5%,63mW,L,CHIP,8P,TP	
RA205	2011-000002	R-NETWORK	22ohm,5%,63mW,L,CHIP,8P,TP	
RA206	2011-000002	R-NETWORK	22ohm,5%,63mW,L,CHIP,8P,TP	
RA207	2011-000002	R-NETWORK	22ohm,5%,63mW,L,CHIP,8P,TP	
RA208	2011-000002	R-NETWORK	22ohm,5%,63mW,L,CHIP,8P,TP	
RA209	2011-000002	R-NETWORK	22ohm,5%,63mW,L,CHIP,8P,TP	
RA210	2011-000002	R-NETWORK	22ohm,5%,63mW,L,CHIP,8P,TP	
RA211	2011-000002	R-NETWORK	22ohm,5%,63mW,L,CHIP,8P,TP	
RA212	2011-000002	R-NETWORK	22ohm,5%,63mW,L,CHIP,8P,TP	
RA301	2011-000002	R-NETWORK	22ohm,5%,63mW,L,CHIP,8P,TP	
RA302	2011-000002	R-NETWORK	22ohm,5%,63mW,L,CHIP,8P,TP	
RA303	2011-000002	R-NETWORK	22ohm,5%,63mW,L,CHIP,8P,TP	SNA
RA304	2011-000002	R-NETWORK	22ohm,5%,63mW,L,CHIP,8P,TP	SNA
RA305	2011-000002	R-NETWORK	22ohm,5%,63mW,L,CHIP,8P,TP	SNA
RA306	2011-000002	R-NETWORK	22ohm,5%,63mW,L,CHIP,8P,TP	SNA
RA307	2011-000002	R-NETWORK	22ohm,5%,63mW,L,CHIP,8P,TP	SNA
RA401	2011-000002	R-NETWORK	22ohm,5%,63mW,L,CHIP,8P,TP	SNA
RA402	2011-000002	R-NETWORK	22ohm,5%,63mW,L,CHIP,8P,TP	SNA
RA403	2011-000002	R-NETWORK	22ohm,5%,63mW,L,CHIP,8P,TP	SNA
RA404	2011-000002	R-NETWORK	22ohm,5%,63mW,L,CHIP,8P,TP	SNA
RA405	2011-000002	R-NETWORK	22ohm,5%,63mW,L,CHIP,8P,TP	SNA
RA406	2011-000002	R-NETWORK	22ohm,5%,63mW,L,CHIP,8P,TP	SNA
RA601	2011-000002	R-NETWORK	22ohm,5%,63mW,L,CHIP,8P,TP	SNA
RA602	2011-000002	R-NETWORK	22ohm,5%,63mW,L,CHIP,8P,TP	SNA
RA603	2011-000002	R-NETWORK	22ohm,5%,63mW,L,CHIP,8P,TP	SNA
RA604	2011-000002	R-NETWORK	22ohm,5%,63mW,L,CHIP,8P,TP	SNA
RA605	2011-000002	R-NETWORK	22ohm,5%,63mW,L,CHIP,8P,TP	SNA
RA701	2011-000002	R-NETWORK	22ohm,5%,63mW,L,CHIP,8P,TP	SNA
RA702	2011-000002	R-NETWORK	22ohm,5%,63mW,L,CHIP,8P,TP	SNA
RA703	2011-000002	R-NETWORK	22ohm,5%,63mW,L,CHIP,8P,TP	SNA
RA704	2011-000002	R-NETWORK	22ohm,5%,63mW,L,CHIP,8P,TP	SNA
RA705	2011-000002	R-NETWORK	22ohm,5%,63mW,L,CHIP,8P,TP	SNA
RA706	2011-000002	R-NETWORK	22ohm,5%,63mW,L,CHIP,8P,TP	SNA

Loc. No.	Code No.	Description	Specification	Remarks
RA707	2011-000002	R-NETWORK	22ohm,5%,63mW,L,CHIP,8P,TP	SNA
RA708	2011-000002	R-NETWORK	22ohm,5%,63mW,L,CHIP,8P,TP	SNA
RA709	2011-000002	R-NETWORK	22ohm,5%,63mW,L,CHIP,8P,TP	SNA
RA710	2011-000002	R-NETWORK	22ohm,5%,63mW,L,CHIP,8P,TP	SNA
RA711	2011-000002	R-NETWORK	22ohm,5%,63mW,L,CHIP,8P,TP	SNA
RA801	2011-000002	R-NETWORK	22ohm,5%,63mW,L,CHIP,8P,TP	SNA
RA802	2011-000002	R-NETWORK	22ohm,5%,63mW,L,CHIP,8P,TP	SNA
RA803	2011-000002	R-NETWORK	22ohm,5%,63mW,L,CHIP,8P,TP	SNA
RA804	2011-000002	R-NETWORK	22ohm,5%,63mW,L,CHIP,8P,TP	SNA
RA805	2011-000002	R-NETWORK	22ohm,5%,63mW,L,CHIP,8P,TP	SNA
RA806	2011-000002	R-NETWORK	22ohm,5%,63mW,L,CHIP,8P,TP	SNA
RA807	2011-000002	R-NETWORK	22ohm,5%,63mW,L,CHIP,8P,TP	SNA
RA808	2011-000002	R-NETWORK	22ohm,5%,63mW,L,CHIP,8P,TP	SNA
RA809	2011-000002	R-NETWORK	22ohm,5%,63mW,L,CHIP,8P,TP	SNA
RA810	2011-000002	R-NETWORK	22ohm,5%,63mW,L,CHIP,8P,TP	SNA
RA811	2011-000002	R-NETWORK	22ohm,5%,63mW,L,CHIP,8P,TP	SNA
RA812	2011-000002	R-NETWORK	22ohm,5%,63mW,L,CHIP,8P,TP	SNA
RA813	2011-000002	R-NETWORK	22ohm,5%,63mW,L,CHIP,8P,TP	SNA
RA814	2011-000002	R-NETWORK	22ohm,5%,63mW,L,CHIP,8P,TP	SNA
RA815	2011-000002	R-NETWORK	22ohm,5%,63mW,L,CHIP,8P,TP	SNA
RA816	2011-000002	R-NETWORK	22ohm,5%,63mW,L,CHIP,8P,TP	SNA
RA817	2011-000002	R-NETWORK	22ohm,5%,63mW,L,CHIP,8P,TP	SNA
X1	2801-003755	CRYSTAL-SMD	20MHZ,30PPM,28-AAN,20PF,500HM,TP	
X1001	2801-001473	CRYSTAL-SMD	4MHz,50ppm,28-AAN,18pF,150ohm,	
X101	2801-003667	CRYSTAL-SMD	14.3182MHz,50PPM,28-AAN,16,500HM,TP	
X301	2801-004004	CRYSTAL-SMD	20.25MHz,20ppm,28-AAN,13pF,25ohm,TP	
X501	2801-003843	CRYSTAL-SMD	18.432MHz,30ppm,28-AAN,20pF,50ohm,TP	SNA
X701	2804-001521	OSCILLATOR-CLOCK	27MHz,50PPM,HCMOS,TP,3.3V,25MA	SNA
ZD1	0403-000579	DIODE-ZENER	BZX84C5V1,5.1V,5%,200mW,SOT-23	SNA
ZD1001	0402-000553	DIODE-RECTIFIER	SS24,40V,2.0A,DO-214AA	SNA
ZD2	0403-000579	DIODE-ZENER	BZX84C5V1,5.1V,5%,200mW,SOT-23	SNA
ZD201	0403-000579	DIODE-ZENER	BZX84C5V1,5.1V,5%,200mW,SOT-23	SNA
ZD202	0403-000579	DIODE-ZENER	BZX84C5V1,5.1V,5%,200mW,SOT-23	SNA
ZD203	0403-000579	DIODE-ZENER	BZX84C5V1,5.1V,5%,200mW,SOT-23	SNA
ZD204	0403-000579	DIODE-ZENER	BZX84C5V1,5.1V,5%,200mW,SOT-23	SNA
ZD205	0403-000579	DIODE-ZENER	BZX84C5V1,5.1V,5%,200mW,SOT-23	SNA
ZD501	0403-000579	DIODE-ZENER	BZX84C5V1,5.1V,5%,200mW,SOT-23	SNA
ZD502	0403-001052	DIODE-ZENER	RD8.2MB,8.2V,7.7-8.64V,200mW,S	
ZD503	0403-001052	DIODE-ZENER	RD8.2MB,8.2V,7.7-8.64V,200mW,S	
ZD504	0403-001052	DIODE-ZENER	RD8.2MB,8.2V,7.7-8.64V,200mW,S	
ZD505	0403-000579	DIODE-ZENER	BZX84C5V1,5.1V,5%,200mW,SOT-23	
ZD506	0403-001052	DIODE-ZENER	RD8.2MB,8.2V,7.7-8.64V,200mW,S	
ZD507	0403-001052	DIODE-ZENER	RD8.2MB,8.2V,7.7-8.64V,200mW,S	
ZD510	0403-000579	DIODE-ZENER	BZX84C5V1,5.1V,5%,200mW,SOT-23	
ZD511	0403-000579	DIODE-ZENER	BZX84C5V1,5.1V,5%,200mW,SOT-23	
ZD512	0403-000579	DIODE-ZENER	BZX84C5V1,5.1V,5%,200mW,SOT-23	
ZD950	0402-000553	DIODE-RECTIFIER	SS24,40V,2.0A,DO-214AA	
ZD951	0402-000553	DIODE-RECTIFIER	SS24,40V,2.0A,DO-214AA	
ZD952	0402-000553	DIODE-RECTIFIER	SS24,40V,2.0A,DO-214AA	
ZD953	0402-000553	DIODE-RECTIFIER	SS24,40V,2.0A,DO-214AA	
ZD954	0402-000553	DIODE-RECTIFIER	SS24,40V,2.0A,DO-214AA	
ZD955	0402-000553	DIODE-RECTIFIER	SS24,40V,2.0A,DO-214AA	SNA
-	BN94-00372A	ASSY PCB MISC-RTA PCB	AL29JO,AL29JO-SXR5/8080	SNA
CIS02	0202-001222	SOLDER-WIRE FLUX	RS-107,RS60-1.2AA,D1.2,SN60/PB40,-	SNA
CIS99	BN73-00025A	RUBBER CUSHION	AL29NO,CR,10*15.60,T4,BLACK,3M #9448	SNA
-	BN97-00157A	ASSY SMD-RTA	AL29JO,AL29JO-SXR5/8080	SNA
BD200	3301-001163	CORE-FERRITE BEAD	AB,80ohm,2x1.25x1mm,300mA,TP,FERRITE,0.08ohm	SNA
BD700	3301-001163	CORE-FERRITE BEAD	AB,80ohm,2x1.25x1mm,300mA,TP,FERRITE,0.08ohm	
BD701	3301-001163	CORE-FERRITE BEAD	AB,80ohm,2x1.25x1mm,300mA,TP,FERRITE,0.08ohm	
BD702	3301-001163	CORE-FERRITE BEAD	AB,80ohm,2x1.25x1mm,300mA,TP,FERRITE,0.08ohm	
C106	2203-000257	C-CERAMIC,CHIP	10nF,10%,50V,X7R,TP,1608	
C107	2203-000189	C-CERAMIC,CHIP	100nF,+80-20%,25V,Y5V,TP,1608,	
C108	2402-001044	C-AL,SMD	100UF,20%,25V,GP,TP,8.3X8.3X6.3MM	
C109	2402-001044	C-AL,SMD	100UF,20%,25V,GP,TP,8.3X8.3X6.3MM	
C110	2203-000257	C-CERAMIC,CHIP	10nF,10%,50V,X7R,TP,1608	
C111	2203-000189	C-CERAMIC,CHIP	100nF,+80-20%,25V,Y5V,TP,1608,	
C112	2402-001044	C-AL,SMD	100UF,20%,25V,GP,TP,8.3X8.3X6.3MM	
C113	2402-001044	C-AL,SMD	100UF,20%,25V,GP,TP,8.3X8.3X6.3MM	

Loc. No.	Code No.	Description	Specification	Remarks
C114	2402-001044	C-AL,SMD	100UF,20%,25V,GP,TP,8.3X8.3X6.3MM	
C115	2402-000176	C-AL,SMD	10uF,20%,16V,GP,TP,4.3x4.3x5.4	
C200	2402-001155	C-AL,SMD	47UF,20%,16V,WT,TP,6.3X5.2MM	
C201	2203-000189	C-CERAMIC,CHIP	100nF,+80-20%,25V,Y5V,TP,1608,	
C202	2203-000189	C-CERAMIC,CHIP	100nF,+80-20%,25V,Y5V,TP,1608,	
C203	2203-000189	C-CERAMIC,CHIP	100nF,+80-20%,25V,Y5V,TP,1608,	
C204	2203-000189	C-CERAMIC,CHIP	100nF,+80-20%,25V,Y5V,TP,1608,	
C205	2203-000189	C-CERAMIC,CHIP	100nF,+80-20%,25V,Y5V,TP,1608,	
C206	2203-000189	C-CERAMIC,CHIP	100nF,+80-20%,25V,Y5V,TP,1608,	
C207	2203-000189	C-CERAMIC,CHIP	100nF,+80-20%,25V,Y5V,TP,1608,	
C208	2203-000189	C-CERAMIC,CHIP	100nF,+80-20%,25V,Y5V,TP,1608,	
C209	2203-000189	C-CERAMIC,CHIP	100nF,+80-20%,25V,Y5V,TP,1608,	
C210	2203-000189	C-CERAMIC,CHIP	100nF,+80-20%,25V,Y5V,TP,1608,	
C211	2203-000189	C-CERAMIC,CHIP	100nF,+80-20%,25V,Y5V,TP,1608,	
C212	2402-001155	C-AL,SMD	47UF,20%,16V,WT,TP,6.3X5.2MM	
C213	2203-000189	C-CERAMIC,CHIP	100nF,+80-20%,25V,Y5V,TP,1608,	
C214	2203-000189	C-CERAMIC,CHIP	100nF,+80-20%,25V,Y5V,TP,1608,	
C215	2203-000189	C-CERAMIC,CHIP	100nF,+80-20%,25V,Y5V,TP,1608,	
C216	2203-000189	C-CERAMIC,CHIP	100nF,+80-20%,25V,Y5V,TP,1608,	
C217	2203-000189	C-CERAMIC,CHIP	100nF,+80-20%,25V,Y5V,TP,1608,	
C218	2203-000189	C-CERAMIC,CHIP	100nF,+80-20%,25V,Y5V,TP,1608,	
C219	2203-000189	C-CERAMIC,CHIP	100nF,+80-20%,25V,Y5V,TP,1608,	
C220	2203-000189	C-CERAMIC,CHIP	100nF,+80-20%,25V,Y5V,TP,1608,	
C221	2402-001155	C-AL,SMD	47UF,20%,16V,WT,TP,6.3X5.2MM	
C222	2203-000189	C-CERAMIC,CHIP	100nF,+80-20%,25V,Y5V,TP,1608,	
C223	2203-000189	C-CERAMIC,CHIP	100nF,+80-20%,25V,Y5V,TP,1608,	
C224	2203-000189	C-CERAMIC,CHIP	100nF,+80-20%,25V,Y5V,TP,1608,	
C225	2402-001155	C-AL,SMD	47UF,20%,16V,WT,TP,6.3X5.2MM	
C226	2203-000189	C-CERAMIC,CHIP	100nF,+80-20%,25V,Y5V,TP,1608,	
C227	2203-000189	C-CERAMIC,CHIP	100nF,+80-20%,25V,Y5V,TP,1608,	
C228	2203-000189	C-CERAMIC,CHIP	100nF,+80-20%,25V,Y5V,TP,1608,	
C229	2203-000440	C-CERAMIC,CHIP	1nF,10%,50V,X7R,TP,1608,-	
C230	2402-000176	C-AL,SMD	10uF,20%,16V,GP,TP,4.3x4.3x5.4	
C231	2203-000189	C-CERAMIC,CHIP	100nF,+80-20%,25V,Y5V,TP,1608,	
C232	2203-000189	C-CERAMIC,CHIP	100nF,+80-20%,25V,Y5V,TP,1608,	
C233	2203-000189	C-CERAMIC,CHIP	100nF,+80-20%,25V,Y5V,TP,1608,	
C234	2203-000189	C-CERAMIC,CHIP	100nF,+80-20%,25V,Y5V,TP,1608,	
C235	2203-000189	C-CERAMIC,CHIP	100nF,+80-20%,25V,Y5V,TP,1608,	
C236	2203-000189	C-CERAMIC,CHIP	100nF,+80-20%,25V,Y5V,TP,1608,	
C237	2402-001044	C-AL,SMD	100UF,20%,25V,GP,TP,8.3X8.3X6.3MM	
C238	2203-000189	C-CERAMIC,CHIP	100nF,+80-20%,25V,Y5V,TP,1608,	
C239	2203-000189	C-CERAMIC,CHIP	100nF,+80-20%,25V,Y5V,TP,1608,	
C240	2203-000189	C-CERAMIC,CHIP	100nF,+80-20%,25V,Y5V,TP,1608,	
C241	2203-000189	C-CERAMIC,CHIP	100nF,+80-20%,25V,Y5V,TP,1608,	
C242	2203-000189	C-CERAMIC,CHIP	100nF,+80-20%,25V,Y5V,TP,1608,	
C243	2203-000189	C-CERAMIC,CHIP	100nF,+80-20%,25V,Y5V,TP,1608,	
C244	2203-000189	C-CERAMIC,CHIP	100nF,+80-20%,25V,Y5V,TP,1608,	
C245	2203-000189	C-CERAMIC,CHIP	100nF,+80-20%,25V,Y5V,TP,1608,	
C246	2203-000189	C-CERAMIC,CHIP	100nF,+80-20%,25V,Y5V,TP,1608,	
C247	2203-000189	C-CERAMIC,CHIP	100nF,+80-20%,25V,Y5V,TP,1608,	
C248	2203-000189	C-CERAMIC,CHIP	100nF,+80-20%,25V,Y5V,TP,1608,	
C249	2203-000189	C-CERAMIC,CHIP	100nF,+80-20%,25V,Y5V,TP,1608,	
C250	2203-000189	C-CERAMIC,CHIP	100nF,+80-20%,25V,Y5V,TP,1608,	
C251	2203-000189	C-CERAMIC,CHIP	100nF,+80-20%,25V,Y5V,TP,1608,	
C252	2203-000189	C-CERAMIC,CHIP	100nF,+80-20%,25V,Y5V,TP,1608,	
C501	2402-000176	C-AL,SMD	10uF,20%,16V,GP,TP,4.3x4.3x5.4	
C502	2203-000189	C-CERAMIC,CHIP	100nF,+80-20%,25V,Y5V,TP,1608,	
C700	2402-000176	C-AL,SMD	10uF,20%,16V,GP,TP,4.3x4.3x5.4	
C701	2203-000440	C-CERAMIC,CHIP	1nF,10%,50V,X7R,TP,1608,-	
C702	2402-000176	C-AL,SMD	10uF,20%,16V,GP,TP,4.3x4.3x5.4	
C703	2203-000440	C-CERAMIC,CHIP	1nF,10%,50V,X7R,TP,1608,-	
C704	2402-000176	C-AL,SMD	10uF,20%,16V,GP,TP,4.3x4.3x5.4	
C705	2203-000440	C-CERAMIC,CHIP	1nF,10%,50V,X7R,TP,1608,-	
C706	2203-000440	C-CERAMIC,CHIP	1nF,10%,50V,X7R,TP,1608,-	
C707	2203-000440	C-CERAMIC,CHIP	1nF,10%,50V,X7R,TP,1608,-	
C708	2203-000440	C-CERAMIC,CHIP	1nF,10%,50V,X7R,TP,1608,-	
C710	2402-001044	C-AL,SMD	100UF,20%,25V,GP,TP,8.3X8.3X6.3MM	
C711	2203-000189	C-CERAMIC,CHIP	100nF,+80-20%,25V,Y5V,TP,1608,	
C712	2203-000189	C-CERAMIC,CHIP	100nF,+80-20%,25V,Y5V,TP,1608,	
C713	2203-000189	C-CERAMIC,CHIP	100nF,+80-20%,25V,Y5V,TP,1608,	















Loc. No.	Code No.	Description	Specification	Remarks
R589	2007-000070	R-CHIP	0ohm,5%,1/16W,DA,TP,1608	
R590	2007-000070	R-CHIP	0ohm,5%,1/16W,DA,TP,1608	
R591	2007-000070	R-CHIP	0ohm,5%,1/16W,DA,TP,1608	
R592	2007-000070	R-CHIP	0ohm,5%,1/16W,DA,TP,1608	
R593	2007-000070	R-CHIP	0ohm,5%,1/16W,DA,TP,1608	
R594	2007-000070	R-CHIP	0ohm,5%,1/16W,DA,TP,1608	
R595	2007-000070	R-CHIP	0ohm,5%,1/16W,DA,TP,1608	
R596	2007-000070	R-CHIP	0ohm,5%,1/16W,DA,TP,1608	
R597	2007-000070	R-CHIP	0ohm,5%,1/16W,DA,TP,1608	
R598	2007-000070	R-CHIP	0ohm,5%,1/16W,DA,TP,1608	
R599	2007-000070	R-CHIP	0ohm,5%,1/16W,DA,TP,1608	
R600	2007-000070	R-CHIP	0ohm,5%,1/16W,DA,TP,1608	
R601	2007-000070	R-CHIP	0ohm,5%,1/16W,DA,TP,1608	
R602	2007-000070	R-CHIP	0ohm,5%,1/16W,DA,TP,1608	
R603	2007-000070	R-CHIP	0ohm,5%,1/16W,DA,TP,1608	
R604	2007-000070	R-CHIP	0ohm,5%,1/16W,DA,TP,1608	
R605	2007-000070	R-CHIP	0ohm,5%,1/16W,DA,TP,1608	
R606	2007-000070	R-CHIP	0ohm,5%,1/16W,DA,TP,1608	
R607	2007-000070	R-CHIP	0ohm,5%,1/16W,DA,TP,1608	
R608	2007-000070	R-CHIP	0ohm,5%,1/16W,DA,TP,1608	
R609	2007-000070	R-CHIP	0ohm,5%,1/16W,DA,TP,1608	
R610	2007-000070	R-CHIP	0ohm,5%,1/16W,DA,TP,1608	
R611	2007-000070	R-CHIP	0ohm,5%,1/16W,DA,TP,1608	
R612	2007-000070	R-CHIP	0ohm,5%,1/16W,DA,TP,1608	
R613	2007-000070	R-CHIP	0ohm,5%,1/16W,DA,TP,1608	
R614	2007-000070	R-CHIP	0ohm,5%,1/16W,DA,TP,1608	
R615	2007-000070	R-CHIP	0ohm,5%,1/16W,DA,TP,1608	
R616	2007-000070	R-CHIP	0ohm,5%,1/16W,DA,TP,1608	
R617	2007-000070	R-CHIP	0ohm,5%,1/16W,DA,TP,1608	
R618	2007-000070	R-CHIP	0ohm,5%,1/16W,DA,TP,1608	
R619	2007-000070	R-CHIP	0ohm,5%,1/16W,DA,TP,1608	
R620	2007-000070	R-CHIP	0ohm,5%,1/16W,DA,TP,1608	
R702	2007-000070	R-CHIP	0ohm,5%,1/16W,DA,TP,1608	
R703	2007-000070	R-CHIP	0ohm,5%,1/16W,DA,TP,1608	
R704	2007-000070	R-CHIP	0ohm,5%,1/16W,DA,TP,1608	
R708	2007-000070	R-CHIP	0ohm,5%,1/16W,DA,TP,1608	
R709	2007-000070	R-CHIP	0ohm,5%,1/16W,DA,TP,1608	
R710	2007-000070	R-CHIP	0ohm,5%,1/16W,DA,TP,1608	
R711	2007-000070	R-CHIP	0ohm,5%,1/16W,DA,TP,1608	
R712	2007-000070	R-CHIP	0ohm,5%,1/16W,DA,TP,1608	
R713	2007-000070	R-CHIP	0ohm,5%,1/16W,DA,TP,1608	
R714	2007-000070	R-CHIP	0ohm,5%,1/16W,DA,TP,1608	
R715	2007-000070	R-CHIP	0ohm,5%,1/16W,DA,TP,1608	
R716	2007-000070	R-CHIP	0ohm,5%,1/16W,DA,TP,1608	
R717	2007-000070	R-CHIP	0ohm,5%,1/16W,DA,TP,1608	
R718	2007-000070	R-CHIP	0ohm,5%,1/16W,DA,TP,1608	
R719	2007-000070	R-CHIP	0ohm,5%,1/16W,DA,TP,1608	
R720	2007-000070	R-CHIP	0ohm,5%,1/16W,DA,TP,1608	
R721	2007-000070	R-CHIP	0ohm,5%,1/16W,DA,TP,1608	SNA
R722	2007-000070	R-CHIP	0ohm,5%,1/16W,DA,TP,1608	SNA
R723	2007-000070	R-CHIP	0ohm,5%,1/16W,DA,TP,1608	SNA
R724	2007-000070	R-CHIP	0ohm,5%,1/16W,DA,TP,1608	SNA
R725	2007-000070	R-CHIP	0ohm,5%,1/16W,DA,TP,1608	SNA
R726	2007-000070	R-CHIP	0ohm,5%,1/16W,DA,TP,1608	SNA
R727	2007-000070	R-CHIP	0ohm,5%,1/16W,DA,TP,1608	SNA
R728	2007-000070	R-CHIP	0ohm,5%,1/16W,DA,TP,1608	SNA
R729	2007-000070	R-CHIP	0ohm,5%,1/16W,DA,TP,1608	
R730	2007-000070	R-CHIP	0ohm,5%,1/16W,DA,TP,1608	
R731	2007-000070	R-CHIP	0ohm,5%,1/16W,DA,TP,1608	
R732	2007-000070	R-CHIP	0ohm,5%,1/16W,DA,TP,1608	
R735	2007-000070	R-CHIP	0ohm,5%,1/16W,DA,TP,1608	
R736	2007-000070	R-CHIP	0ohm,5%,1/16W,DA,TP,1608	
R737	2007-000070	R-CHIP	0ohm,5%,1/16W,DA,TP,1608	
R738	2007-000084	R-CHIP	4.7Kohm,5%,1/16W,DA,TP,1608	SNA
R739	2007-000070	R-CHIP	0ohm,5%,1/16W,DA,TP,1608	SNA

**6-2-2 LT40A13W Others**

Loc. No.	Code No.	Description	Specification	Remarks
-	BN90-00405A	ASSY COVER REAR	AL40JO	SNA
C/F+C/R	6003-000122	SCREW-TAPTITE	BH,+B,M4,L12,ZPC(YEL),SWRCH18	SNA
C/F+C/R	6003-000124	SCREW-TAPTITE	BH,+B,M4,L25,ZPC(YEL),SWRCH18	SNA
C/R	BN96-00151C	ASSY COVER P-REAR	AL40NO,ABS V0,FOR JAPAN	SNA
C/R	BN63-00244A	COVER-REAR	APOLLO 40,ABS,V0,BK,DARK GREY SPRAY	SNA
-	BN90-00408Y	ASSY STAND	AL40JO	
CIS	BN96-00061B	ASSY STAND P	AL40JO,ABS V0,DGM-2188	
-	BN90-00416A	ASSY COVER FRONT	AL40JO	SNA
P/BRKT+C/F	6003-000129	SCREW-TAPTITE	BH,+S,M4,L10,ZPC(YEL),SWRCH18	SNA
C/F	BN96-00059C	ASSY COVER P-FRONT	AL40AO,ABS V0,FOR JAPAN	SNA
C/F	6003-001188	SCREW-TAPTITE	BH,+B,M4,L10,YEL,SWRCH18A	SNA
C/F	BN59-00290A	BOARD-FUNCTION ASS'Y	AL29NO,CT5000-0600,FUNCTION ASS'Y	SNA
C/F	BN63-00243A	COVER-FRONT	APOLLO 40,ABS,V0,IV,PEARL WHITE SPRAY	SNA
C/F	BN64-00062A	KNOB-FUNCTION	APOLLO29,ABS+PC,5V,SILVER	
C/F	BN64-00064A	KNOB-RING	APOLLO 40,ABS,HB,CLEAR,NI COATING	
C/F	BN64-00090D	BADGE-BRAND	APOLLO,AL,T1.5,12.5,72,BLM-6238,SAMSUNG(LAYERGLOSS)	
C/F	BN67-00055A	LENS-LED	APOLLO29,ACRYL,CLEAR	SNA
C/F	BN67-00057A	LENS-MIRROR(HALF)	APOLLO 40,ACRYL,CLEAR,AL COATING	SNA
C/F	BN67-00070A	LENS-IR	APOLLO29,ACRYL,CLEAR	
-	BN91-00386B	ASSY MISC-ADAPTOP	AL29UO,U.S.A	SNA
CIS	BN44-00067B	ADAPTOR	PSCV221101B,APPOLO,JAPAN AREA,AC100-240V,47-63HZ,DC28V,DC8A,224W,AC/DC,-10-+40C,	
-	BN91-00407A	ASSY LCD	AL40AO	SNA
CIS	BN07-00064A	LCD	TM396WX-71N31,RS24NS,6BIT FRC,922.0*580.0*56.0,16.7M,40,0.6735*0.6735,0-40,5.0,T	
-	BN91-00489A	ASSY CHASSIS	AL40JO	
-	BN91-00491A	ASSY SHIELD	AL40JO	SNA
AUD/PCB+C/F	6003-001188	SCREW-TAPTITE	BH,+B,M4,L10,YEL,SWRCH18A	SNA
BRKT+C/F	6003-000009	SCREW-TAPTITE	BH,+B,M4,L16,ZPC(YEL),SWRCH18	SNA
CIS	3809-001395	FPC CABLE-FLAT	--,40MM,64P,0.5MM,-	
CIS	6502-001082	CABLE CLAMP	DAFC-2000,-T6.2,NYLON 66,NTR	SNA
CIS	6502-001083	CABLE CLAMP	DAMC-25,-T10,NYLON 66,NTR	SNA
CIS	BN39-00268A	LEAD CONNECTOR-ASSY	AL40NO,UL2651#28,UL/CSA,10P,#28,DF3-10S-2C,DF3-10S-2C,BK,280MM,2651#28	
CIS	BN39-00268B	LEAD CONNECTOR-ASSY	AL40NO,UL2651#28,UL/CSA,10P,#28,DF3-10S-2C,DF3-10S-2C,BK,490MM,2651#28	
CIS	BN39-00269B	LEAD CONNECTOR-ASSY	AL40NO,UL2651#28,UL/CSA,9P,#28,12505HS-09,12505HS-09,BK,280MM,2651#28	
CIS	BN39-00269C	LEAD CONNECTOR-ASSY	AL40NO,UL2651#28,UL/CSA,9P,#28,12505HS-09,12505HS-09,BK,490MM,2651#28	
CIS	BN39-00306A	LEAD CONNECTOR	AL40JO,UL20276#30,UL/CSA,30P,#30,12507HS-30,FI-X30H,BK,330MM,20276#30,CORE	
CIS	BN59-00322A	BOARD-CONNECTOR ASSY	APOLLO 40 JAPAN,-,CONNECTOR BOARD ASSY	SNA
CIS	BN59-00323A	BOARD-TUNER ASS'Y	APOLLO 40 JAPAN,-,TUNER BOARD ASS'Y	SNA
CIS	BN61-00111A	BRACKET-PANEL TOP	APOLLO 40,SECC ,T1.6	SNA
CIS	BN61-00112A	BRACKET-PANEL BOTTOM	APOLLO 40,SECC ,T1.6	SNA
CIS	BN63-00450A	GASKET	29 40APOLLO,CONDUCTIVE FABLIC,5MM,10MM,310MM,GRAY,71TSSK-10-RS5-310-13,71TSSK-	SNA
CIS	BN63-00455A	GASKET	40 APOLLO,CONDUCTIVE FABLIC,0.13MM,60MM,100MM,GRAY,DK-K102-60-100,DK-K102-60-10	SNA
CIS	BN63-00456A	GASKET	40 APOLLO,CONDUCTIVE FABLIC,0.13MM,70MM,150MM,GRAY,DK-K102-70-150,DK-K102-70-15	SNA
CIS	BN63-00457A	GASKET	29 APOLLO,CONDUCTIVE FABRIC,0.13MM,50MM,625MM,GRAY,DK-K102-50-625,DK-K102-50-62	SNA
CIS	BN64-00063A	KNOB-POWER	APOLLO 40,ABS+PC,5V	
CIS	BN73-00024A	SILICON/RUBBER-GAP PAD	AL29NO,SILICON,60*20 T3.5,BERGQUIST	SNA
CIS	BN73-00037A	SILICON/RUBBER-GAP PAD	AL40KO,SILICON,45*45 T3.5,BERGQUIST	SNA
CTRL/PCB+C/F	6003-000122	SCREW-TAPTITE	BH,+B,M4,L12,ZPC(YEL),SWRCH18	
M/PCB+PANEL	6003-000269	SCREW-TAPTITE	BH,+S,M3,L6,ZPC(YEL),SWRCH18A	SNA
RTA+PANEL	6003-000269	SCREW-TAPTITE	BH,+S,M3,L6,ZPC(YEL),SWRCH18A	SNA
SH/COV+PAN	6001-000116	SCREW-MACHINE	BH,+M3,L12,NI PLT,SM10C,-	
TUN/PCB+C/F	6003-001188	SCREW-TAPTITE	BH,+B,M4,L10,YEL,SWRCH18A	SNA
CIS	BN96-00060A	ASSY MISC P-BRACKET PANEL	APOLLO 40,SECC T1.6	
CIS	6003-001337	SCREW-TAPTITE	CH,+S,M4,L6,ZPC(YEL),SWRCH18A,-	SNA
CIS	BN61-00096A	BRACKET-SUPPORT L	APOLLO29,SECC T1.6 ,T1.6	SNA
CIS	BN61-00109A	BRACKET-SIDE-L	APOLLO 40,SECC ,T1.6	SNA
CIS	BN61-00110A	BRACKET-SIDE-R	APOLLO 40,SECC ,T1.6	SNA
CIS	BN61-00132A	BRACKET-SUPPORT R	APOLLO29,SECC T1.6 ,T1.6	SNA
CIS	BN96-00198A	ASSY MISC P-SHIELD COVER	AL40NO,SECC T0.5	
CIS	BN63-00427A	SHIELD-PCB-MAIN	AL40NO,SPT,0.5,APOLLO 40	SNA

Loc. No.	Code No.	Description	Specification	Remarks
CIS	BN63-00453A	GASKET	40 APOLLO, CONDUCTIVE FABLIC, 8MM, 30MM, 635MM, GRAY, 71TSSK-30-8-635-13, 71TSSK-30-8-	SNA
CIS	BN63-00454A	GASKET	40 APOLLO, CONDUCTIVE FABLIC, 5MM, 10MM, 393MM, GRAY, 71TSSK-10-RS5-393-13, 71TSSK-10-	SNA
CIS	BN96-00212A	ASSY MISC P-PANEL-STUD	APOLLO40, SECC T0.8 250*220, TAPE	SNA
-	BN92-00577A	ASSY P/MATERIAL	AL40J0	SNA
CIS	BH69-30355F	BAG-PE/N	AL40AO, PE FOAM, 0.5, 320, 210, NTR	SNA
CIS	BH69-30355K	BAG-PE	AL40, PE FOAM, 0.5, 1100, 1200, NTR	SNA
P/M	BN69-00288A	CUSHION-SET	APOLLO 40, EPS 50M	SNA
-	BN92-00582N	ASSY LABEL	LT40A13WX/XS,J,SJC, JAPAN	SNA
CIS	AA68-01404A	LABEL-MANUFACTURED	,T/P, T0.05, 25, 10, JAPAN	
CIS	AA68-50057E	LABEL-WARNING	,A/P 90G, 58, 52, JAPAN	SNA
CIS	BN68-00269B	LABEL RATING	,TETRON, T0.05, 64, 78, NO PRINT	SNA
-	BN92-00584G	ASSY BOX	LT40A13WX/XS,J,SEJ, JAPAN	SNA
BOX	AA68-50054L	LABEL-STICKER	,A/P 90G, 80, 23, SERIAL	SNA
BOX	BN68-00305B	LABEL-BAR, CODE	LT40A13W, A/P(90G), 46, 22	SNA
BOX	BN69-00332B	PACKING-CASE, OUT	LT40A13W, H-3 AB, C3, YEL, JAPAN	SNA
BOX	BN69-00349A	PACKING-CASE, IN	LT40A, CB H-3, AB, 1588, 688, YEL	SNA
CIS	AA68-40069B	CARD-WARRANTY	JAPAN, -, YEL, JAPAN, -	SNA
CIS	BN68-00174F	MANUAL	APOLLO W TY CARD, SYNCMASTER, JAPANESE, JAPAN, MIMOJ080G	SNA
-	BN92-00591U	ASSY ACCESSORY	LT40A13WX/XS,J,SEJ, JAPAN	SNA
CIS	BN59-00314A	REMOCON	,TM63, APPOLO, 47, G6671B, NTSC, EX, JAPAN	
-	2802-000194	RESONATOR-CERAMIC	8MHz, 1.0%, TP, 8.5x4.5x5.0mm	
-	AA09-00275A	IC MICOM	Z86L8808SSC-R51PX, SOP, ST, SZTM-828A2	
CIS	BN96-00160U	ASSY ACCESSORY	LT40A13WX/XS,J,SEJ, JAPAN	
CIS	0203-000214	TAPE-OPP MASKING	OPP/W50/CLR, T0.05, W50, L400000,	SNA
CIS	4301-000121	BATTERY-MN	1.5V, -, AAA, 10.5x44.5m, HOLDER	SNA
CIS	6001-001637	SCREW-MACHINE	BH, +, M4, L25, ZPC(BLK), SWRCH18A, FP, -	
CIS	AA65-30101A	CLAMPER CORE-BACK	-, PE, VO, -, BLK, TOSHIBA	SNA
CIS	BH39-00120A	CBF SIGNAL	-, 2000MM, -, -, UL2851#28, -	
CIS	BH39-10307W	CBF POWER CORD	,VCTF, -, IVY, 1830MM, N, LP-54, LS1	
CIS	BH69-30348D	BAG-PE	LDPE, T0.05, W240*L356, Y, -, CMG73	SNA
CIS	BN39-00057A	CBF SIGNAL-RCA	-, 1500MM, RCA-3P, -, UL2863#25, -	
CIS	BN39-00060A	CBF SIGNAL-DIN	-, 1500MM, -, -, UL2990, 4P MINI DIN	
CIS	BN39-00072A	CBF SIGNAL	DET, 2000MM, 24P/24P, IVORY, -, DVI-D(M) TO DVI-D(M)	
CIS	BN39-00310A	CBF SIGNAL	APOLLO, 15P/24P, 2990, 1830MM, UL2990, IVORY, D-SUB/DVI(D), DET. TYPE	
CIS	BN68-00275C	MANUAL USERS	LT29A13W, LT40A13W, SAMSUNG, JAPANESE, JAPAN, MIMOJ080G	
CIS	BN69-00350B	BOX-ACCESSORY	AL29NO/AO, CB SW-1, YEL, KSD-21, 60, 300, 230, 3 COLOR PRINTING	SNA

# 7 Block Diagram

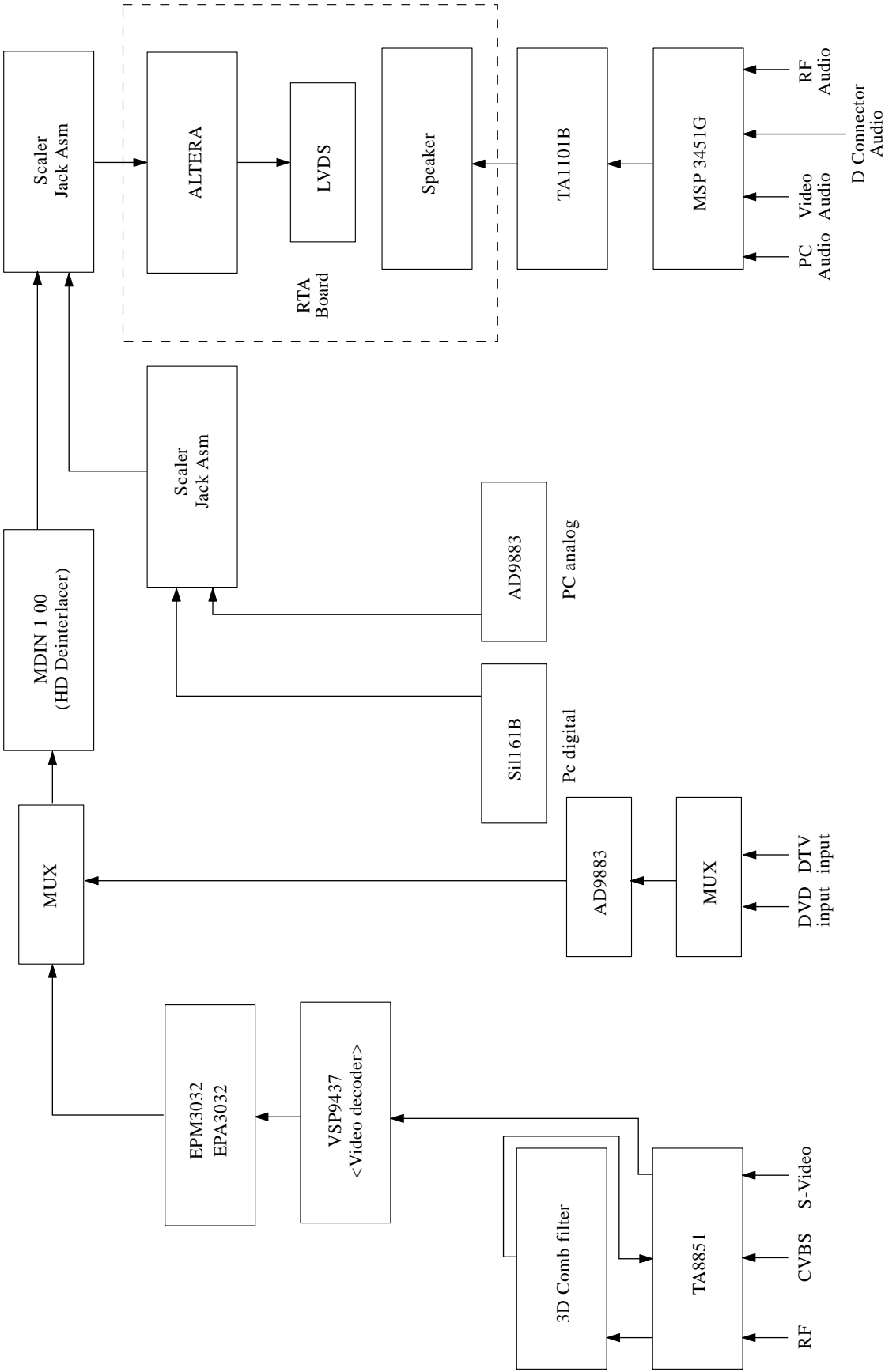

**Memo**



8 Wiring Diagram

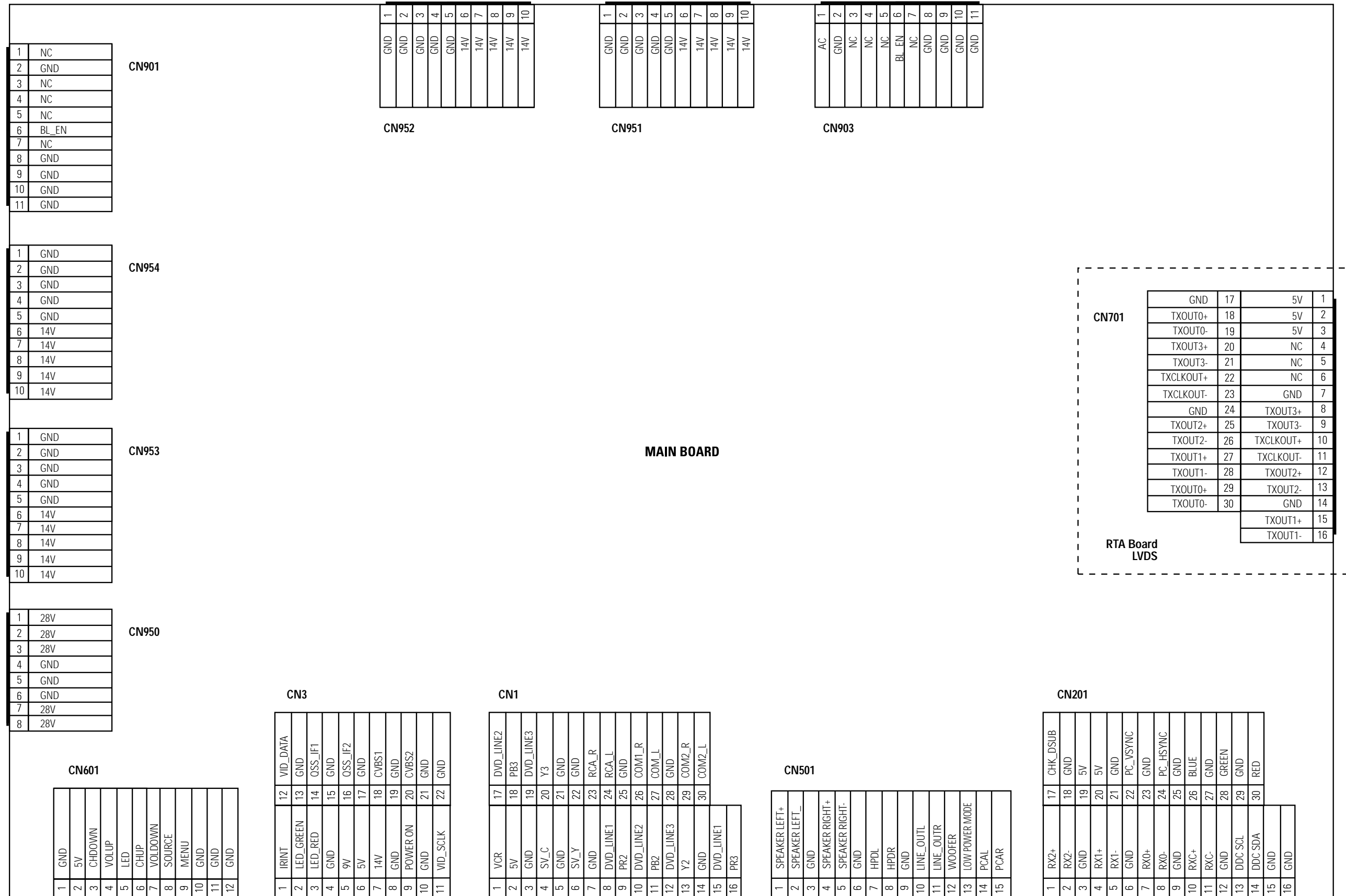

**Memo**

# 9 Schematic Diagrams

## 9-1 Apollo-II\_Top Parts Schematic Diagram

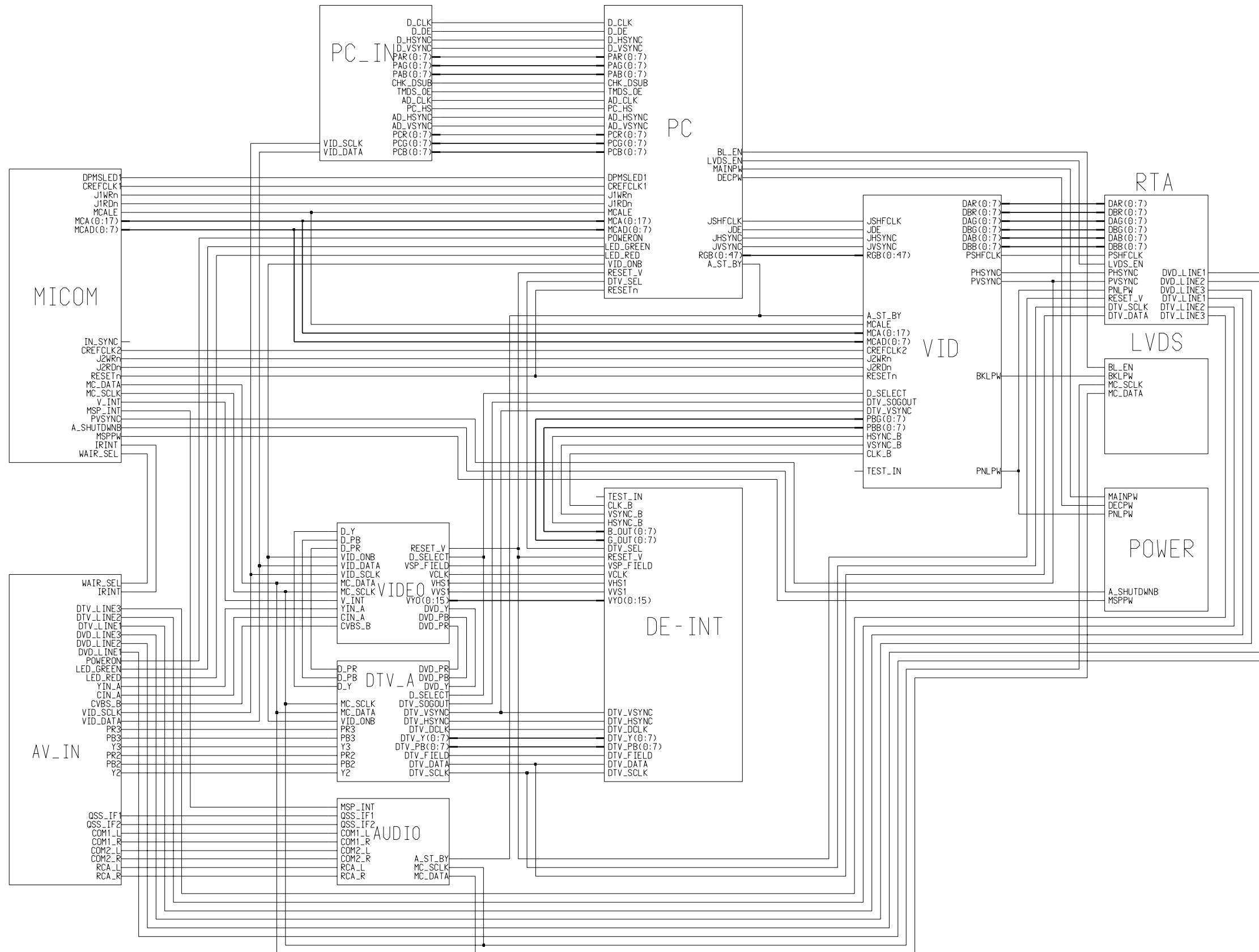

### 9-2 Microm Parts Schematic Diagram

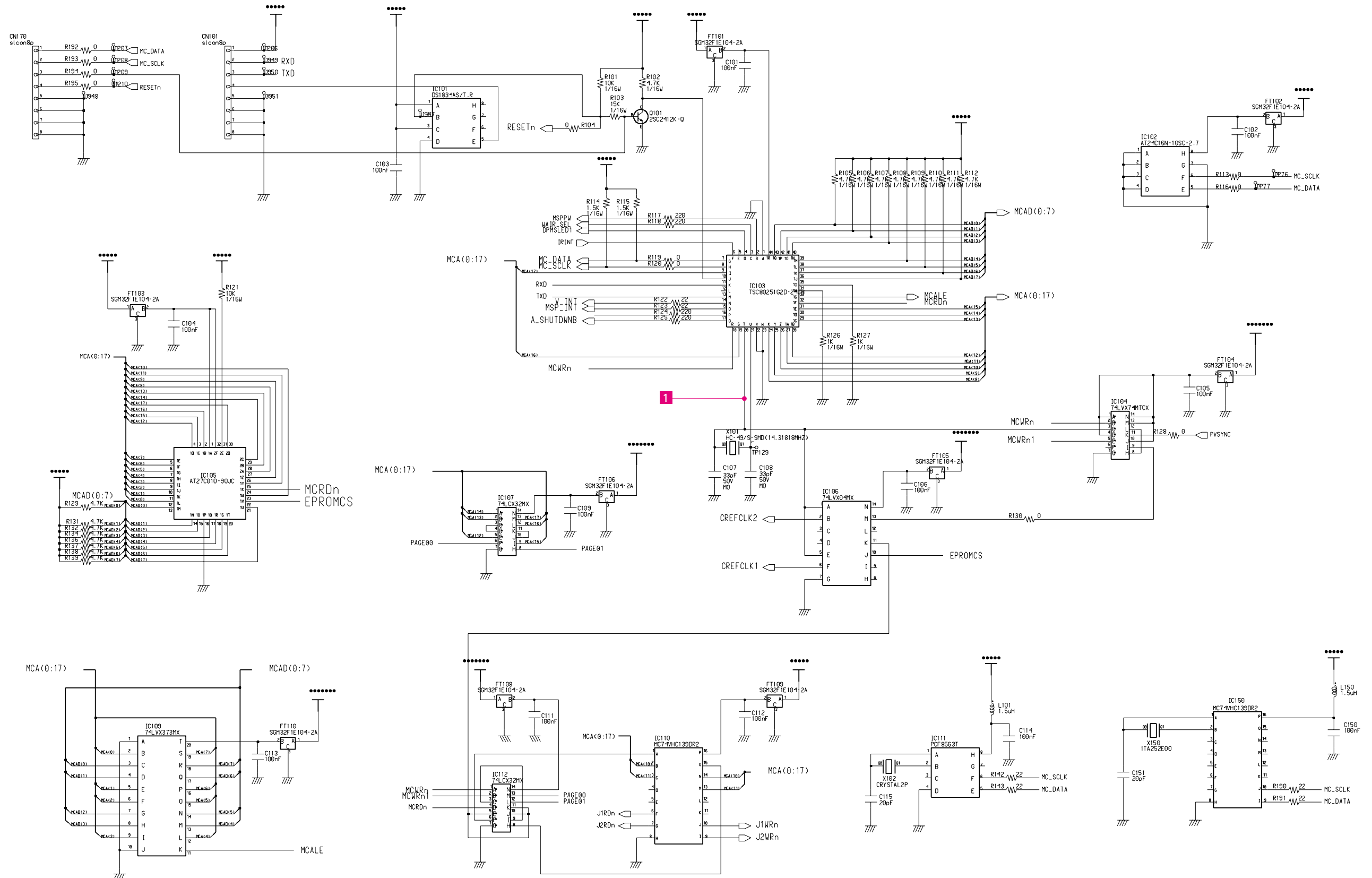

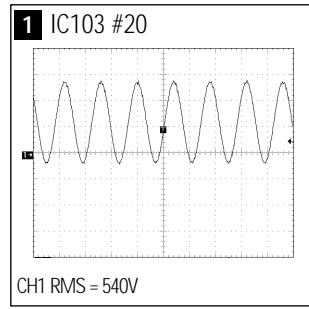

9-3 PC\_IN Parts Schematic Diagram

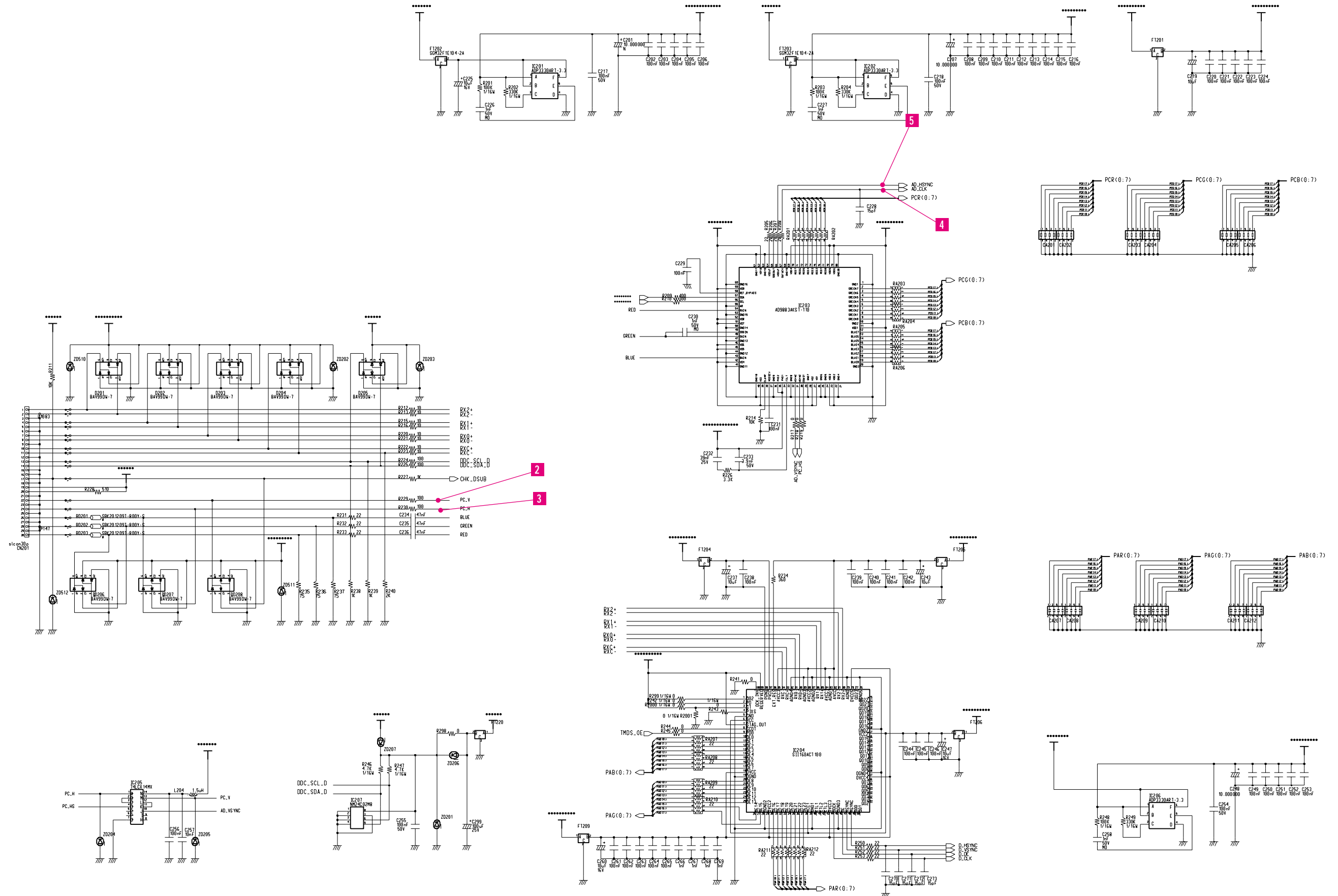

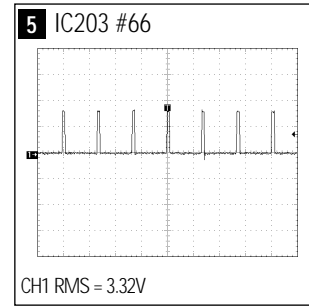
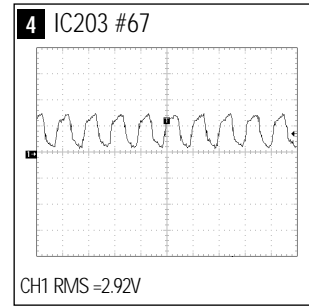
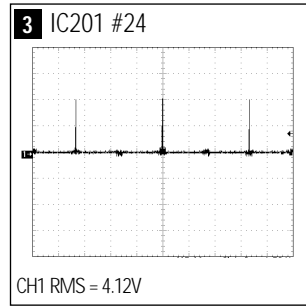
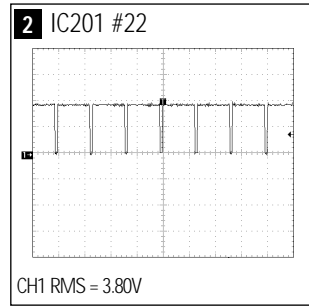

9-4 JAG200ASM\_PC Parts Schematic Diagram

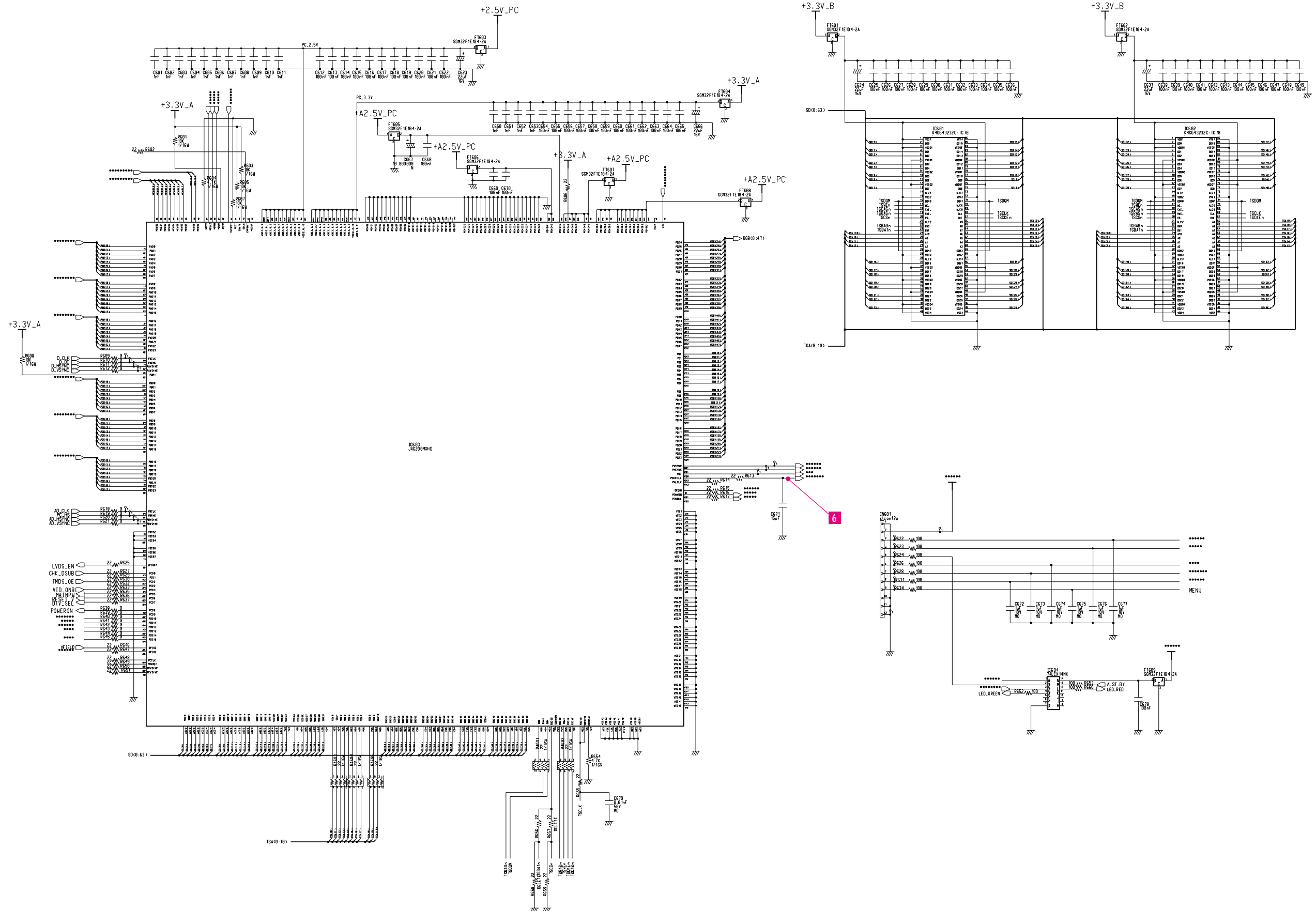



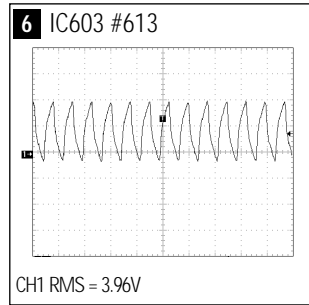

9-5 JAG200ASM\_Video Parts Schematic Diagram

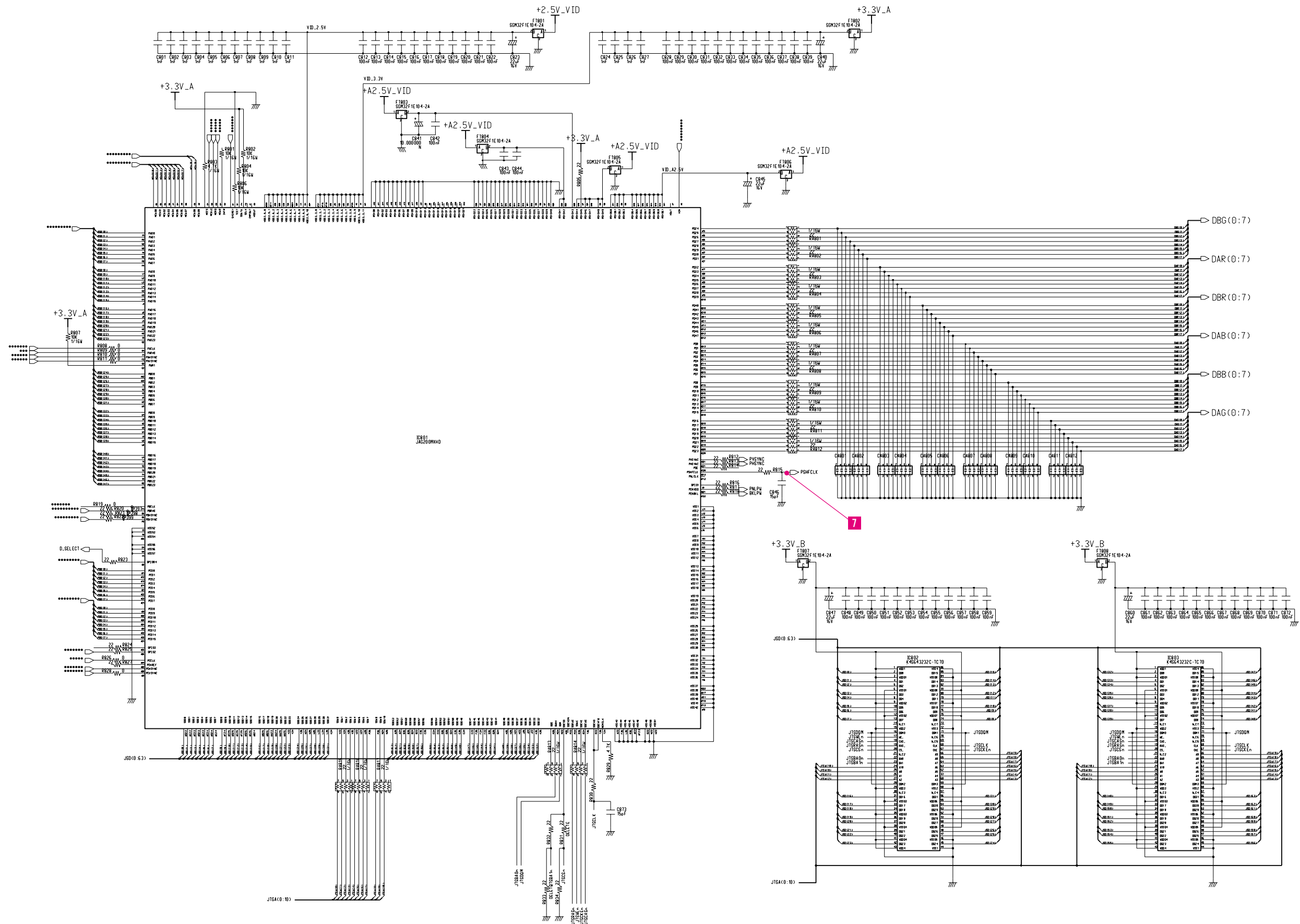

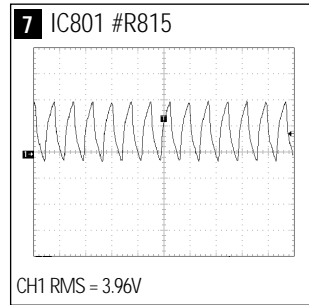

9-6 LVDS Part Schematic Diagram

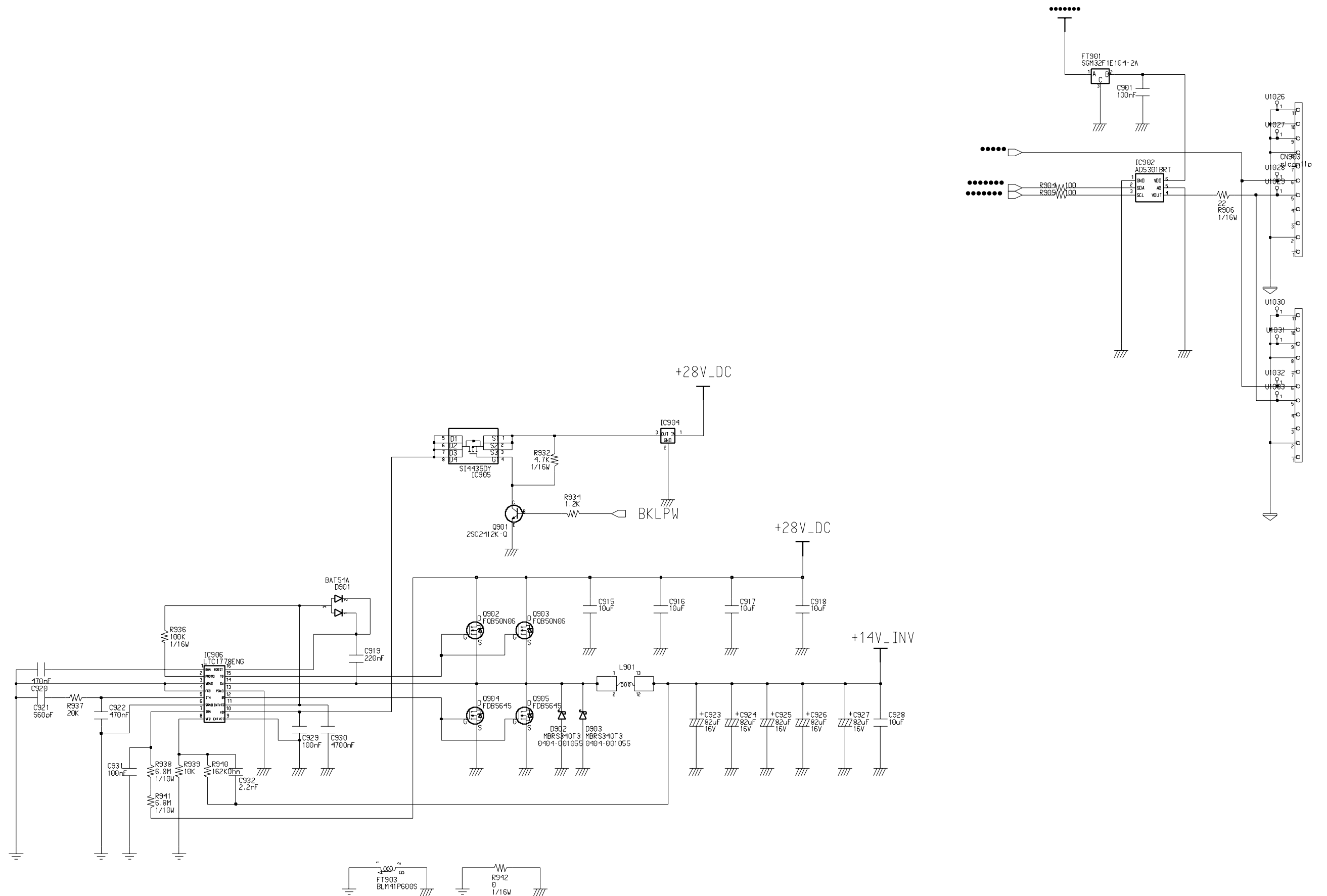

9-7 Deinterlace Parts Schematic Diagram

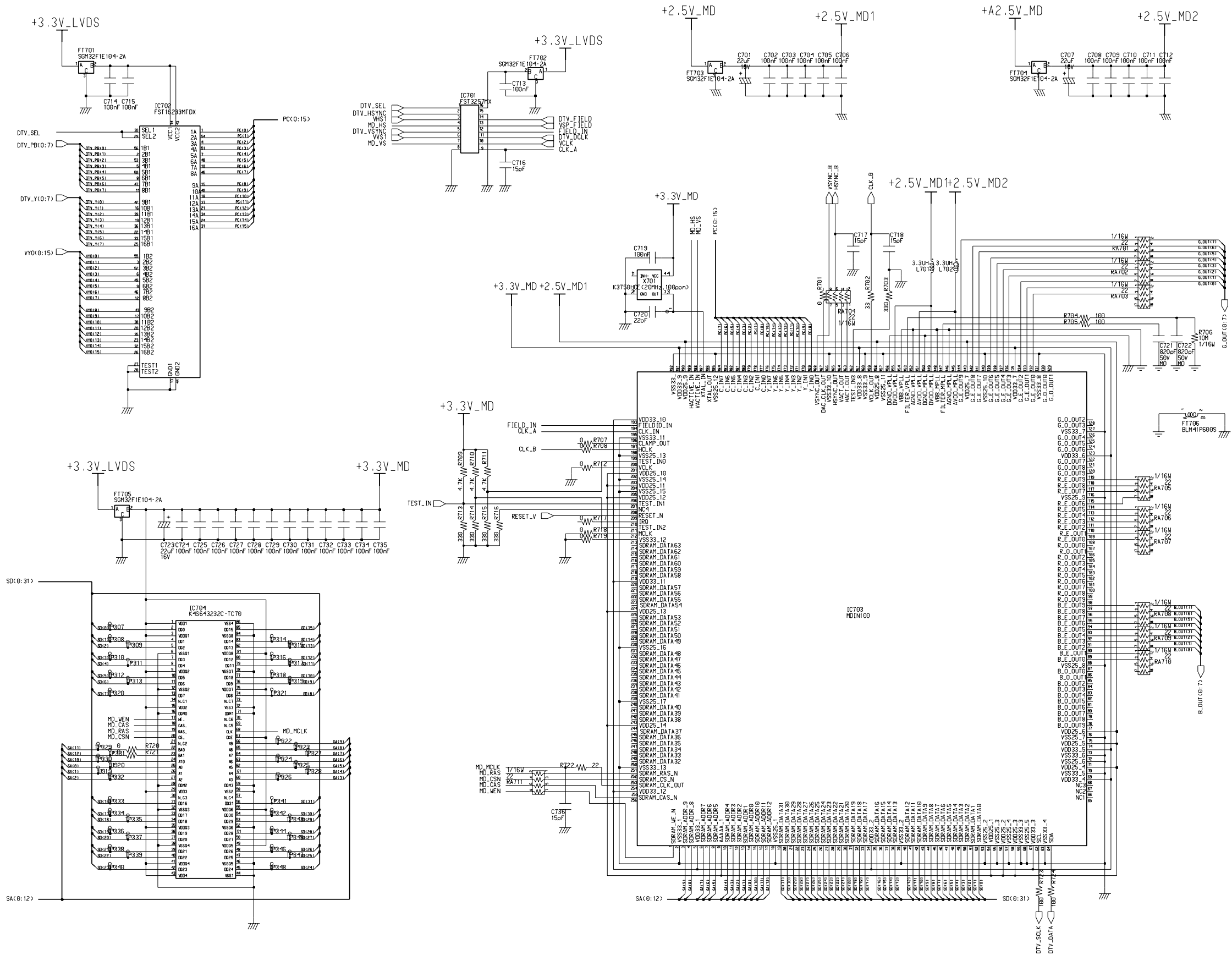



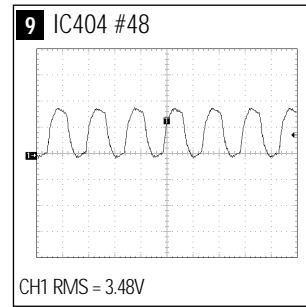
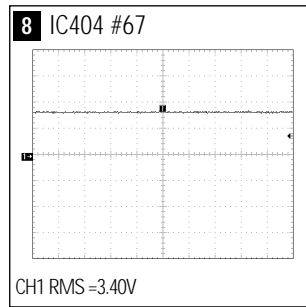

### 9-9 Audio Parts Schematic Diagram

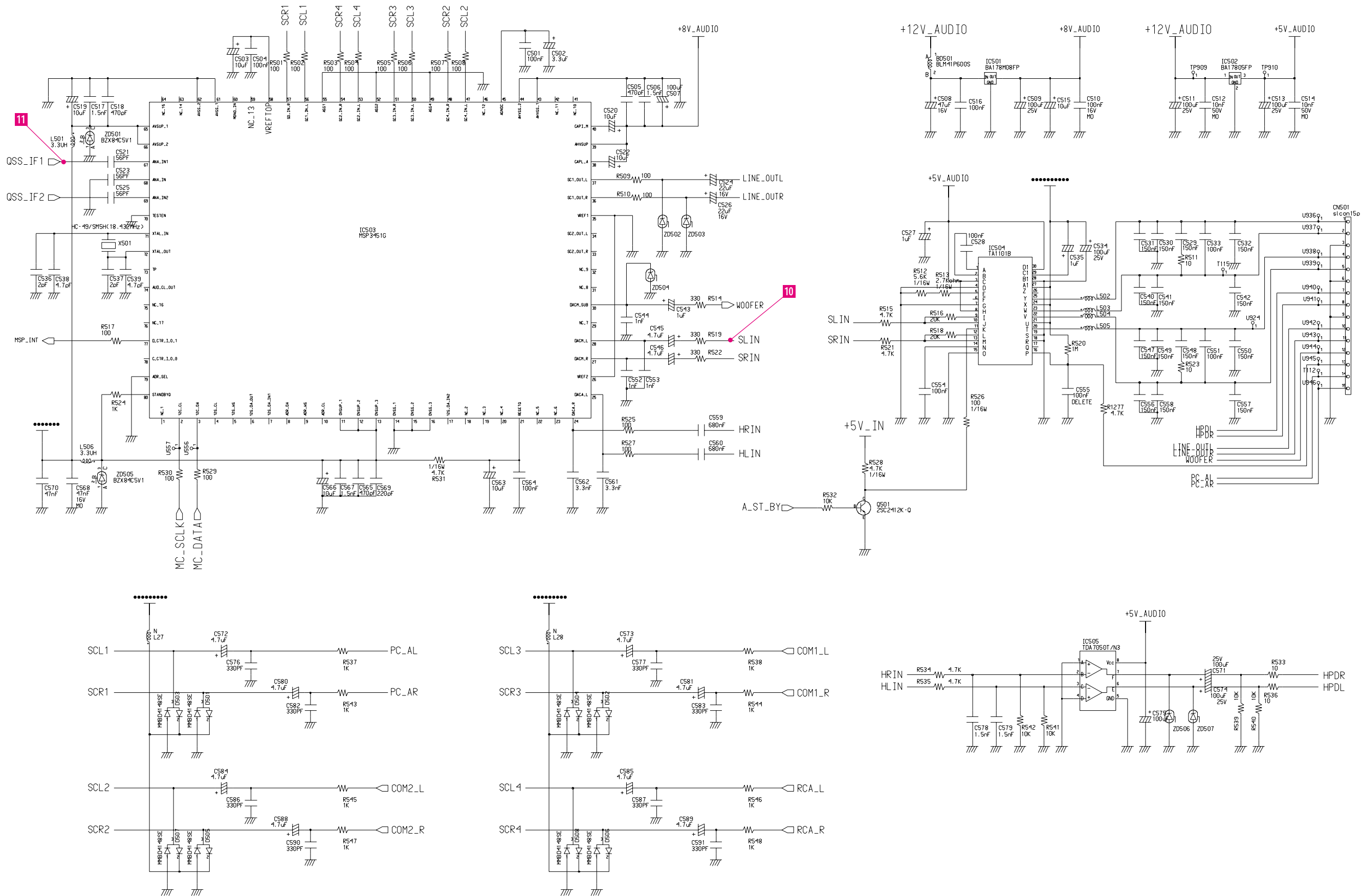



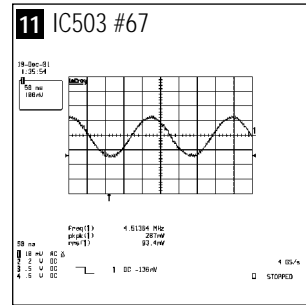
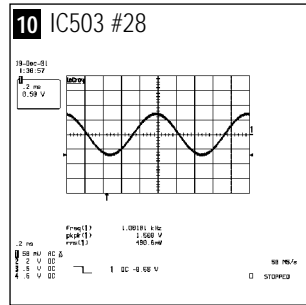

### 9-10 AV\_IN Parts Schematic Diagram

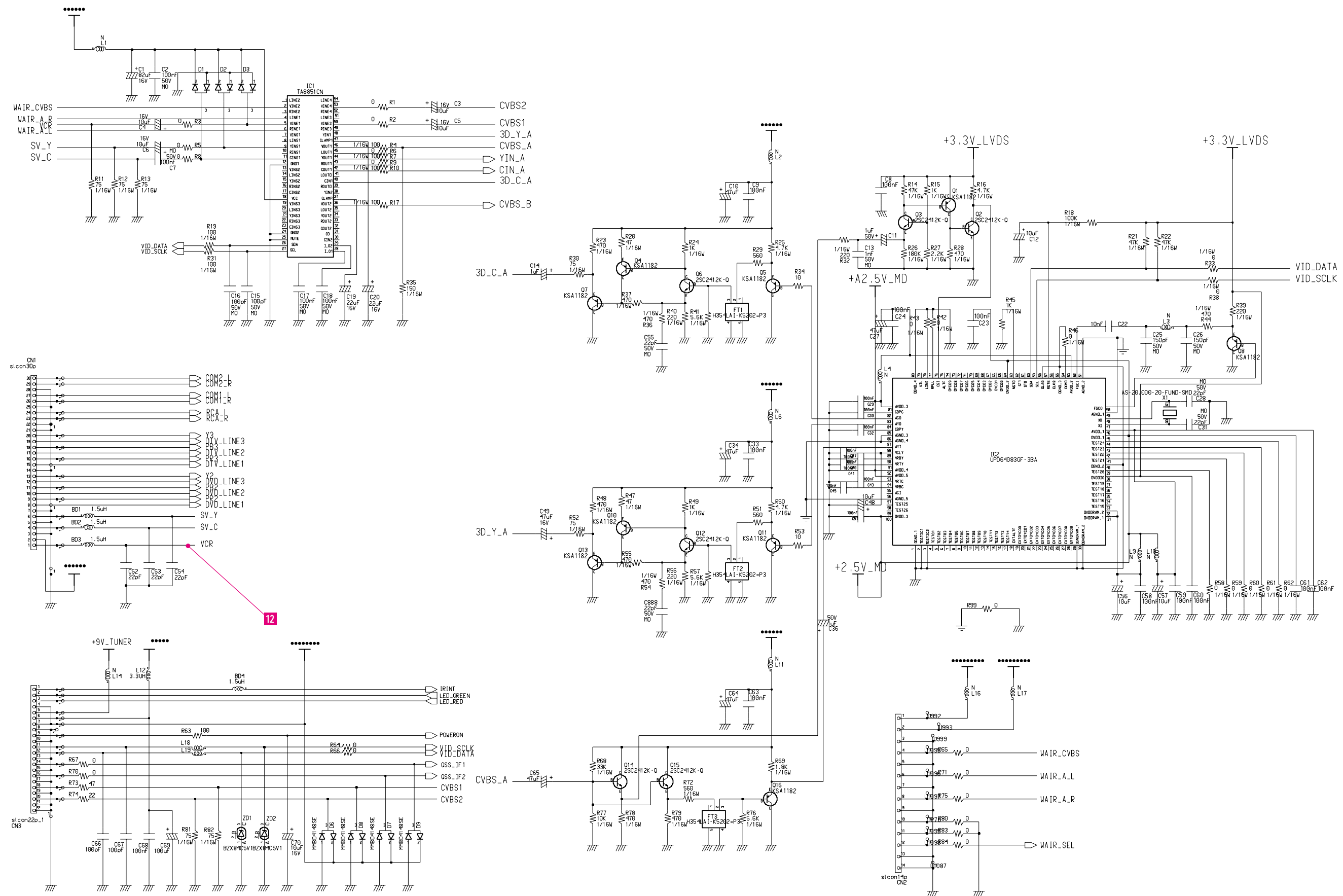



9-11 Power Parts Schematic Diagram

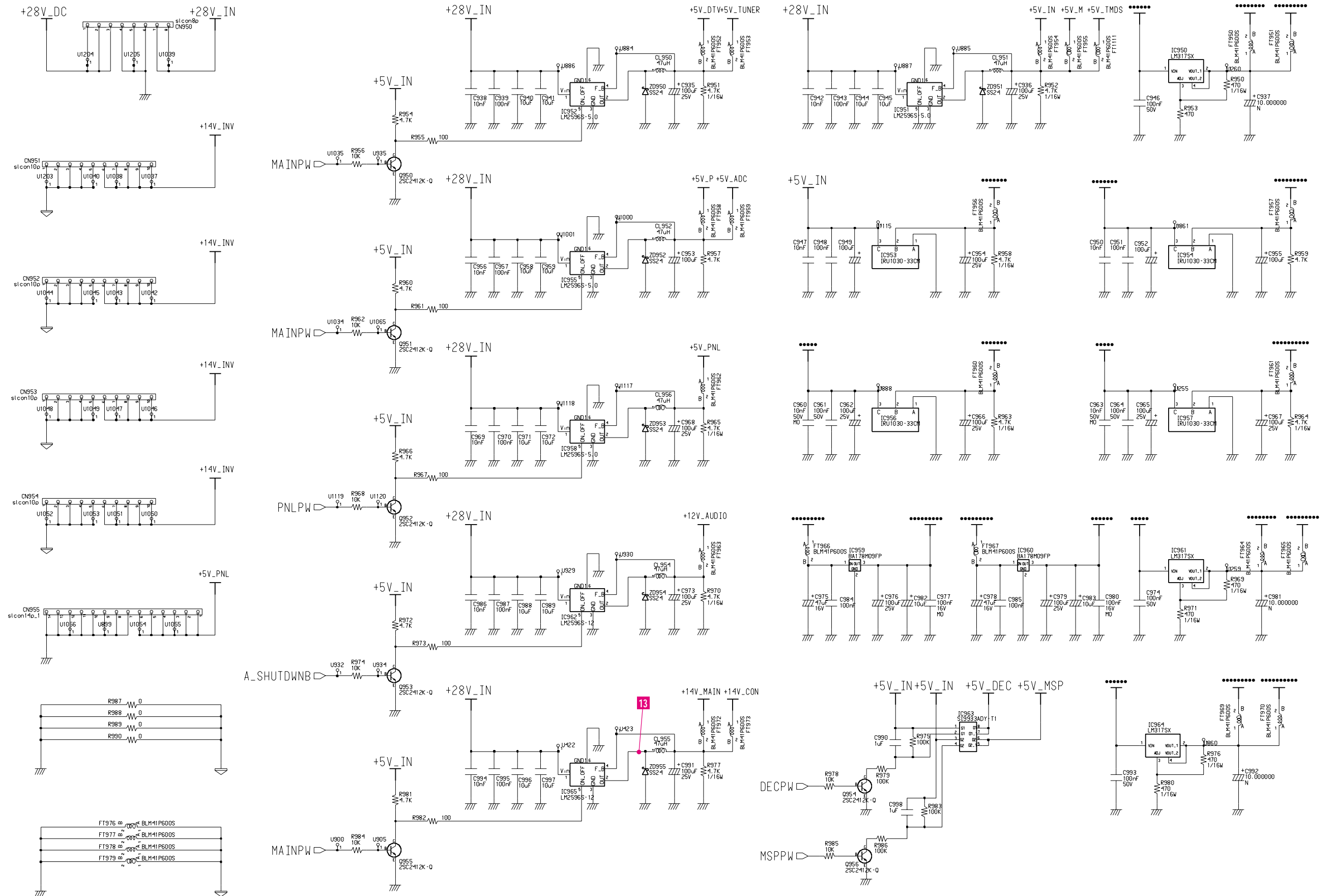

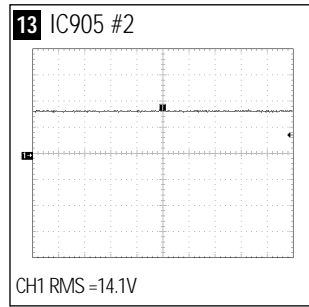

9-12 Video Parts Schematic Diagram

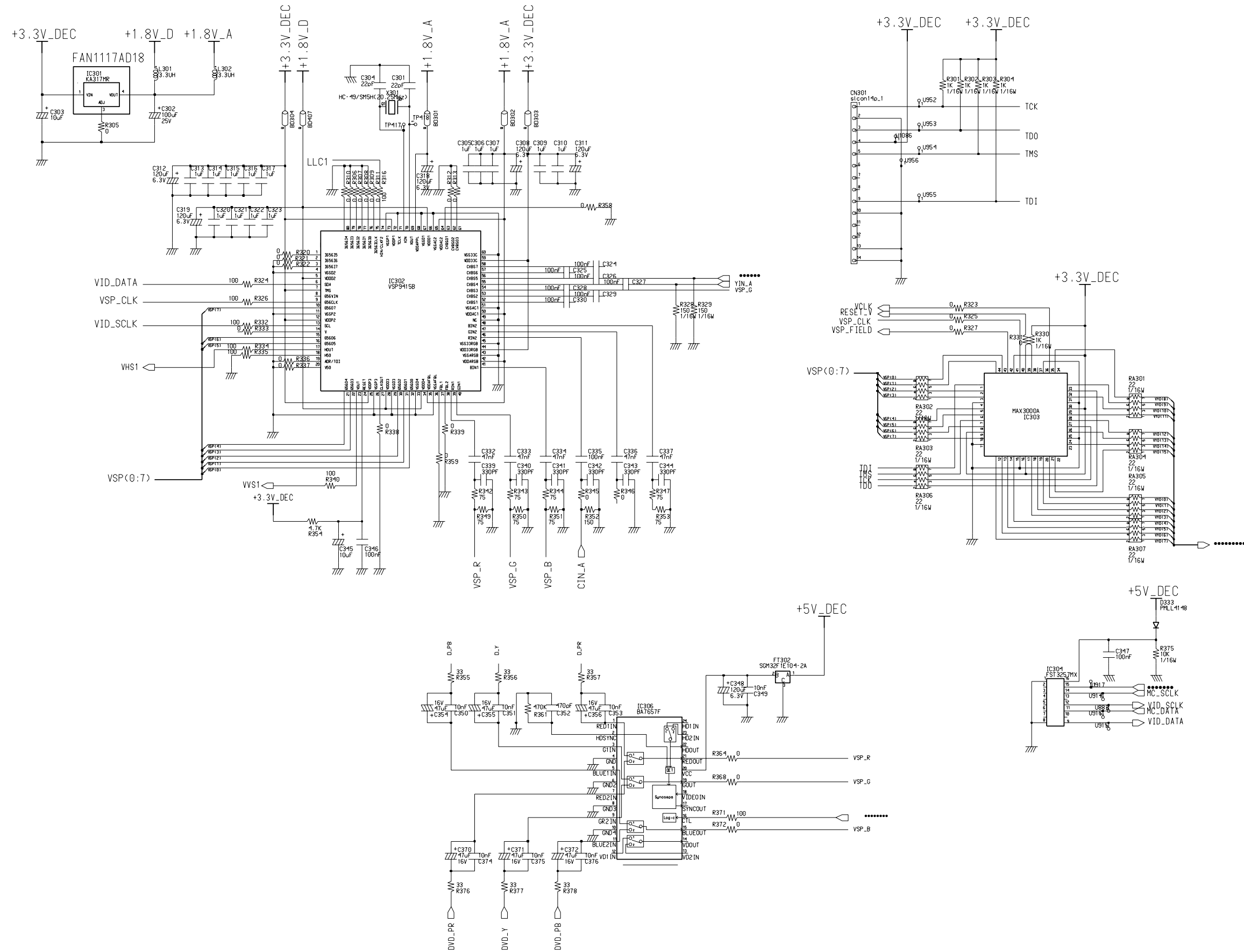

9-13 RTA Parts Schematic Diagram

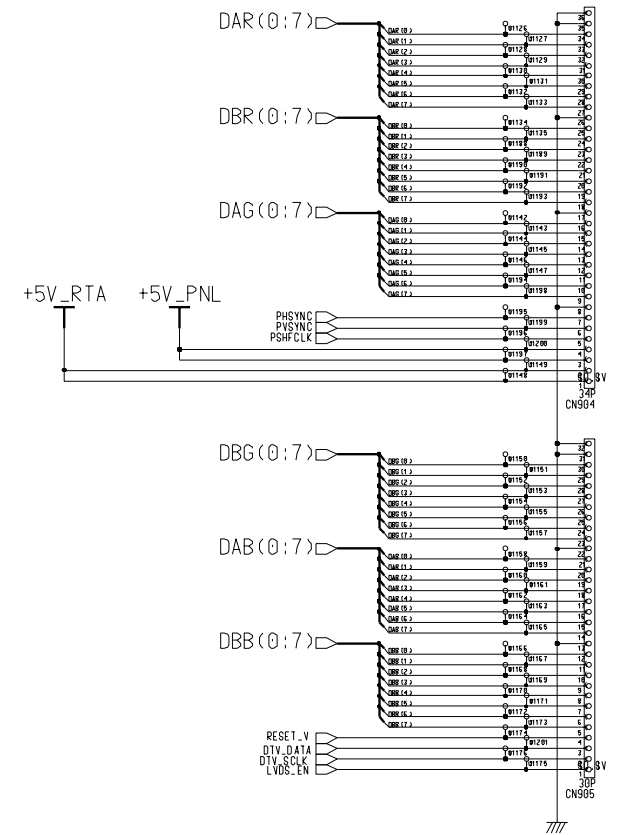
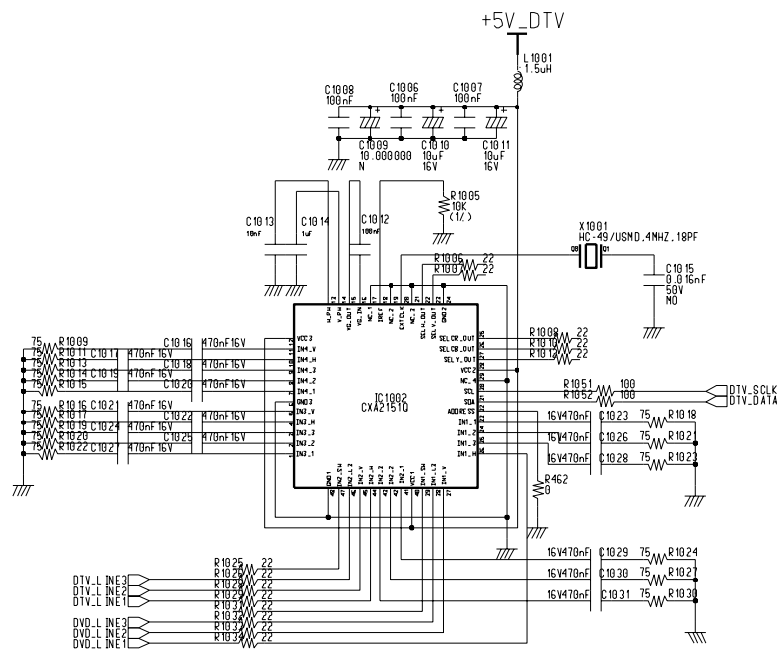
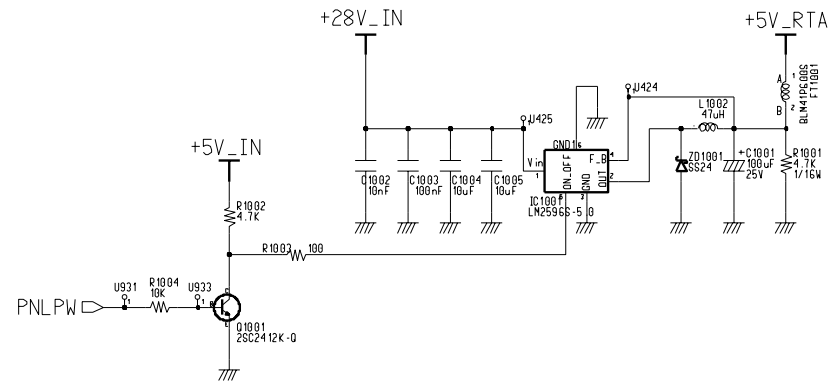







**Samsung Electronics Co.,Ltd.**

416, Maetan-3Dong, Paldal-Gu, Suwon City, Kyungki-Do, Korea.

Printed in Korea

P/N : BN82-00081C-00